

QST 

devoted entirely to

**amateur
radio**

October
1935
25 cents



Culminating a Year of Research—the 45A

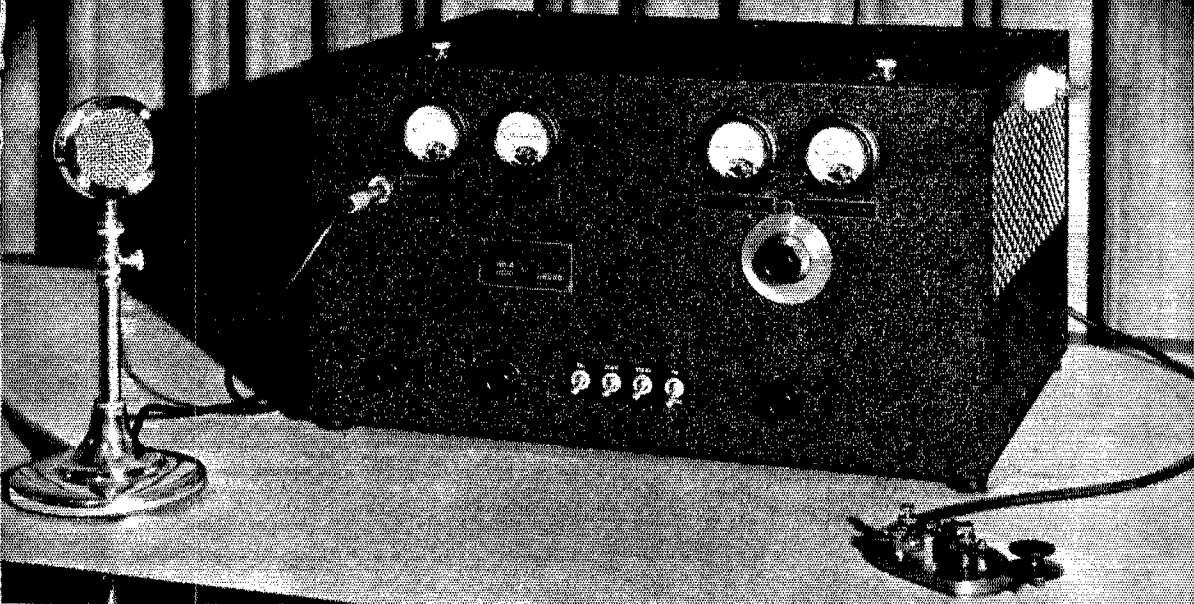

THE 45A is the newest small-sized transmitter. Collins Radio Company engineers have been working steadily to increase the power, improve the efficiency and afford more reliable performance in a low cost transmitter. The 45A embodies the remarkable results of this work. Compact and serviceable in size, it has a man-sized output—40 watts telephone and 125 watts telegraph.

Although efficiency is the keynote of the 45A's performance, it has many other valuable features. For instance, Unitary Frequency Shift permits rapid change to any frequency and there are only two tuning controls on the panel. Good news to high frequency enthusiasts is the fact that the 45A operates on ten meters as well as on the usual frequencies. Most striking and distinctive is the aircraft type cabinet which makes it possible to place the transmitter on the operating table alongside the receiver. Operating controls are conveniently located on the panel. Everything is self contained except: (1) antenna, (2) microphone, (3) key, (4) cord to 110 v. outlet. Dimensions are 21½ inches wide, 16½ inches deep, 11½ inches high. Weight, 125 pounds. Very adaptable to portable use, the 45A may be furnished with shockproof mountings on special order.

The transmitter is designed for use with another important Collins' development — the Multiband Antenna, which for the first time permits one antenna to be used with proper impedance matching in the transmission line on all bands. Several types of this antenna are available for different sorts of locations.

Still other improvements in the 45A are, a totally different type of oscillator tube and circuit, new high fidelity transformer coupling in speech amplifier, a modulation indicator calibrated in percent. and decibels. The price of the complete transmitter is surprisingly low. We will be glad to send details and data on request.

Collins Radio Company

CEDAR RAPIDS
New York
11 West 42nd St.



IOWA, U. S. A.
Mexico City
Edificio "La Nacional"

HAMMARLUND

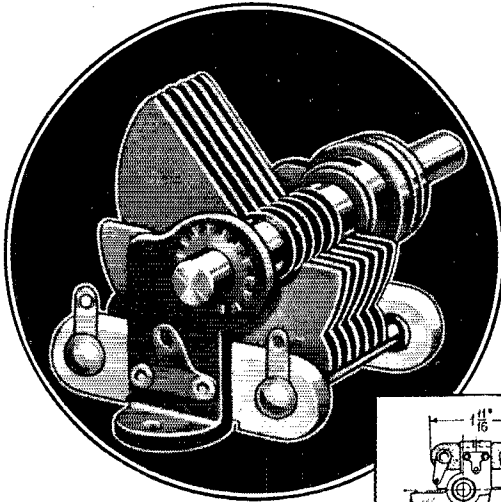

Improved
**MIDGET
CONDENSER**

"Midline" and Straight-line Capacity Types

THE marked efficiency of Hammarlund Condensers was firmly established in 1910. Their dominance has since spread throughout the radio world — in the highly exacting amateur and experimental fields, and in their use by the more prominent manufacturers.

Every feature of Hammarlund Midget Variable Condensers is designed for peak electrical and mechanical performance in the short-wave and ultra short-wave frequencies.

Wide capacity ratios; vibration-proof construction; Isolantite insulation; soldered brass plates; large, smooth, quiet bearings; one-hole or base mounting — all with an eye to dependable, trouble-free, long-lasting service characteristic of Hammarlund workmanship.

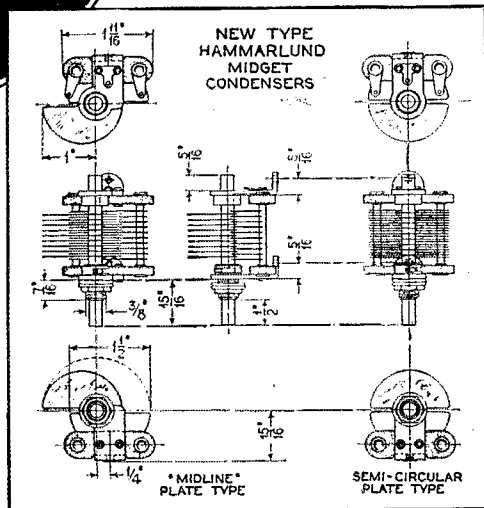

Made in 12 stock sizes, in single and multiple models, with capacity ranges from 3 mmf. minimum to 320 mmf. maximum, and priced at \$1.40 to \$3.50 each, list

Mail Coupon for Complete Catalog of High-Quality Radio Equipment

Canadian Office:
41 West Avenue North,
Hamilton, Ontario



HAMMARLUND MANUFACTURING CO.
424-438 W. 33rd St., New York

Check here for New General Catalog. Check here, and attach 10c, for New 32-page Short-Wave Manual.

Name

Address

..... Q-10

FLASH!

YOU ASKED FOR THEM HERE THEY ARE



MARINE 60-G

200 watts c.w. 60 watts phone

MARINE 750-B

1 k.w. phone and c.w.

with built-in

CATHODE RAY OSCILLOSCOPES

The 60-G was evolved to meet the insistent demands of the amateur for a radically different low cost transmitter.

The 750-B too, was evolved to meet the many requests of the amateurs who want the finest and most powerful transmitter available.

The Marine 750-B has every possible refinement. Some of its features are: frequency range 30,000 to 1500 kc., full complement of meters and relays, built-in Cathode Ray Oscilloscope, permanent neutralization, high fidelity audio channel, antenna matching network, broadcast station type steel cabinets, one year unconditional guarantee, etc.

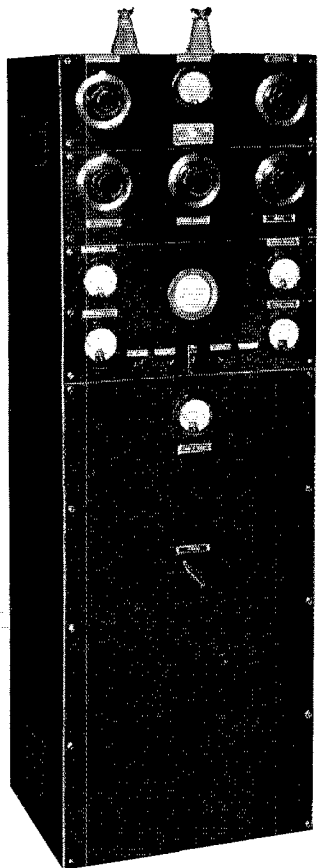

FRONT VIEW—140-B

MARINE 140-B

100 watts phone and c.w.

with built-in

Cathode Ray Oscilloscope

The 140-B illustrated, has been completely described on page 2 in previous issues of *QST*.

The new regulations of the F.C.C. require that adequate means for checking over-modulation of every amateur transmitter shall be employed. The built-in Cathode Ray Oscilloscope is designed for this specific use.

Write for complete details on these and other Marine transmitters.

We manufacture a complete line of transmitters for all purposes.

Marine transmitters are now available through a limited number of reputable jobbers.

GENERAL OFFICES AND PLANT
124-11 - - 101st Avenue
RICHMOND HILL, N. Y.
Telephone: Cleveland 3-2400

MARINE RADIO C O M P A N Y

EXPORT DEPARTMENT
15 LAIGHT STREET
NEW YORK, N. Y.
Cable Address: "Arlab"

QST

Published monthly, as its official organ, by the American Radio Relay League, Inc., at West Hartford, Conn., U. S. A.; Official Organ of the International Amateur Radio Union

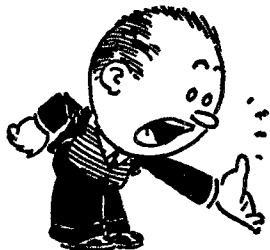

devoted entirely to AMATEUR RADIO

| | |
|--|---------------------------------|
| Editorials | 11 |
| Kansas State Convention | 12 |
| On Top of the U. S. | 13 |
| The Equipment on the "Morrissey" | Don C. Wallace, W6AM |
| Coil Data for "All-Purpose" S. S. Superhet | Bob Moe, W2UN |
| Delta Division Convention | 18 |
| What's In a Circuit | 18 |
| What the League Is Doing | George Grammer |
| Reducing QRM on 56 Mc. | 24 |
| W2MO, Portable, Sets the Pace for 56 Mc. | C. F. Hadlock, WICTW |
| Hamdom | John Diecks, W2HPV |
| A Multi-Purpose Test Circuit | 32 |
| Dr. Jolliffe Discusses Cairo Arrangements | Jim Kirk, W8DEG |
| With the Affiliated Clubs | 36 |
| Shifting Antenna Directivity by Phase Switching | D. A. Griffin, W2AOG |
| Southeastern Division Convention | 37 |
| How to Count Countries Worked | Clinton B. De Soto |
| A Self-Powered V.T. Voltmeter of High Sensitivity | D. C. Duncan |
| A Homemade World Time Clock | Elmer Newell, W7AVN |
| Combined VK/ZL International DX Contest | 45 |
| Modulated Emissions Added to WWV | 46 |
| A Simple Neon Tube Oscilloscope for Amateur Use | D. H. Vollmer, W6CQH |
| Amateur Radio Stations | W1FH, W6TT, W5DAQ, W7BYW, W9JTR |
| Strays | 50 |
| Experimenters' Section | 52 |
| STABILIZING THE 2A7 CONVERTER — NEUTRALIZING THE FINAL — MIDGET PORTABLE RECEIVER — AUTOMATIC PROTECTION WITH GRID-LEAK BIAS — REMAGNETIZING READRITE MILLIAMMETERS — CONTINUOUS MONITORING WITH THE S.S. SUPER — TNT "R" CIRCUIT — "B" POWER FOR KEYING OSCILLATOR — SIMPLE KEYING OSCILLATOR | 53 |
| I.A.R.U. News | 57 |
| Operating News | 59 |
| Correspondence Department | 71 |
| Book Reviews | 76 |
| A.R.R.L. QSL Bureau | 90 |
| Oklahoma State Convention | 90 |
| Maritime Division Convention | 94 |
| Standard Frequency Transmissions | 100 |
| Schedules for WWV | 100 |
| Filent Keys | 102 |
| Atlantic Division Convention | 102 |
| Revised R-S-T System | 106 |
| Hamads | 107 |
| QST's Index of Advertisers | 110 |

OCTOBER
1935

VOLUME XIX
NUMBER 10

Kenneth B. Warner (Secretary, A.R.R.L.), Editor-in-Chief and Business Manager; Ross A. Hull, Associate Editor; James J. Lamb, Technical Editor; George Grammer, Assistant Technical Editor; Clark C. Rodimon, Managing Editor; David H. Houghton, Circulation Manager; F. Cheyney Beekley, Advertising Manager; Ursula M. Chamberlain, Assistant Advertising Manager.

Editorial and Advertising Offices
33 La Salle Road, West Hartford, Conn.

Subscription rate in United States and Possessions and Canada, \$2.50 per year, postpaid; all other countries, \$3.00 per year, postpaid. Single copies, 25 cents. Foreign remittances should be by international postal or express money order or bank draft negotiable in the U. S. and for an equivalent amount in U. S. funds.

Entered as second-class matter May 29, 1919, at the post office at Hartford, Connecticut, under the Act of March 3, 1879. Acceptance for mailing at special rate of postage provided for in section 1103, Act of October 3, 1917, authorized September 9, 1922. Additional entry at Concord, N. H., authorized February 21, 1929, under the Act of February 28, 1925.

Additional second-class entries to cover sectional editions authorized March 20, 1935

Copyright 1935 by the American Radio Relay League, Inc.
Title registered at United States Patent Office.

Mr. Rady Calc and Mrs. Ohmy Calc Announce Arrival of Quadruplets

WEST HARTFORD, CONN., Sept. 15, (ARRL). It has been suspected for long that there would soon be some new members in the Calculator family. But what a surprise it was when Drs. Houghton and Beaudin announced to the world today that quadruplets had arrived! Uncle Jim and Cousin George and Cousin Don were enthusiastic in their praise of all four of the little fellows, saying they would be good companions for their elders and would be equally useful. Except that they are smaller in size, they are much like the old folks, colorful and bright and clean in their cellophane wrappers. The first was immediately named Deci (short for Decibel Calculator, Type D) because even Dr. Houghton could see that he is meant for easy calculation of Decibels when power or current or voltage is known. The second was a bit of a puzzle because he was born with his disc upside down; but Uncle Jim finally straightened that out and found he is really the most ingenious yet. With the aid of any voltmeter and a battery, Ressay (Resistance Calculator, Type F, is the full name) will tell you the resistance of any resistor from one to a million ohms. The third was easy. He's Wiry, the little rascal (whole name, Wire Calculator, Type C). He was born with more data about sizes and resistances and current-carrying capacity and turns per what-have-you than most people could accumulate in a lifetime. Parsey (short for Parallel Resistance, Series Capacity Calculator, Type E) is smart as can be. He tells you right off what the total resistance is of two resistances in *parallel* or the total capacity of two capacities in *series*. Everybody says, "What good is he? I can figure that out easy." But when they try, most of them find they can't be sure.

Mr. and Mrs. Calc say their family is now complete and there won't be any more additions for a long time.



Any of the new little Calcs are available at 50¢ each, postpaid

THE AMERICAN RADIO RELAY LEAGUE, Inc.

WEST HARTFORD, CONNECTICUT

... and now it is
EVEN BETTER!
The New 1936 Super SKYRIDER

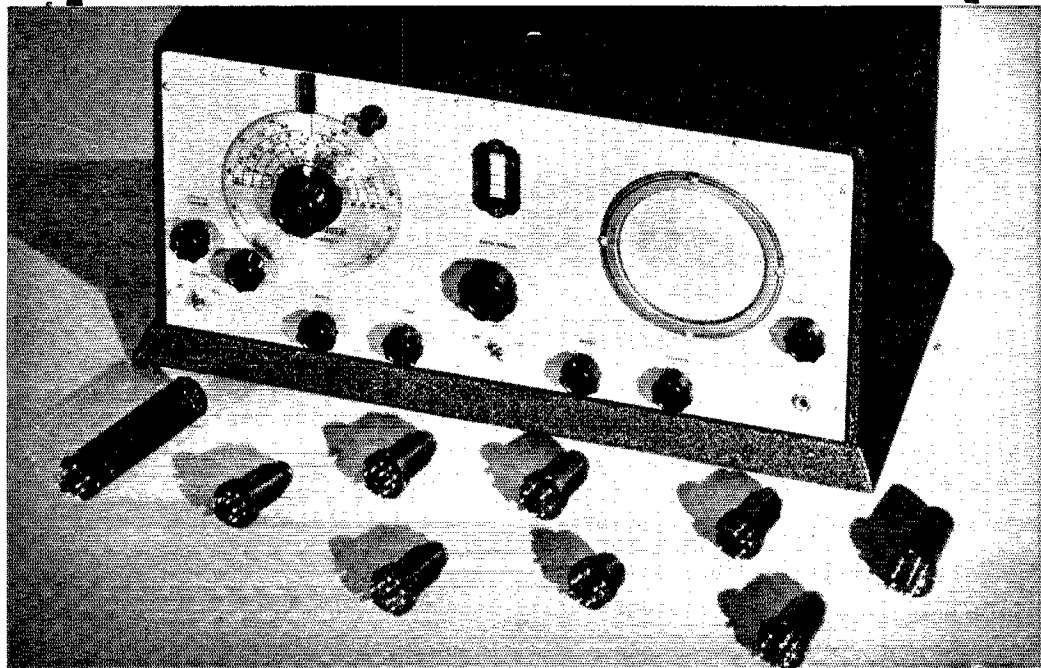

★ From the Hallicrafters Laboratories of Precision comes this new kind of radio, a worthy successor to the highly popular and successful 1935 Sky rider. Built to the same high standards of quality that have won the enthusiastic endorsement of its users everywhere, it gains by comparison with its predecessor by virtue of its superior performance and the new features which Hallicrafters engineers have incorporated into its design. We believe it is today's outstanding value in short-wave receivers, worthy to bear the Hallicrafters signature. Among the new features that contribute to its truly brilliant performance are the following:

- ★ Metal Tubes — elimination of noisy, unsatisfactory tube shields, reduced interelectrode capacities and shorter leads, making possible greater gain and fewer circuit complications.
- ★ Iron-Core I.F. System — especially designed for the 1936 Super SKYRIDER — used for the first time commercially in amateur receivers — having greater sensitivity and a signal-to-noise ratio unattainable with an air core system.
- ★ More efficient Antenna Circuit — better 5 band coverage of all-wave bands from 7.4 to 550 meters (41000 to 540 K.C.) made possible by tuning to the low-frequency end of each band.
- ★ Duo-Micro-Vernier Band Spread — providing improved accuracy of logging — combines electrical band spreading and micro-vernier tuning in an exclusive and distinctive dial with novel illumination.
- ★ Crystal Filter Circuit, controlled by variable knob on front of set, gives one-signal selectivity — without reducing sensitivity! A Dozen other features contribute to the exceptional accuracy and precision of performance, that must be reviewed before the 1936 Super SKYRIDER is fully appreciated.

SEE IT AT YOUR JOBBERS OR WRITE FOR COMPLETE INFORMATION

the hallicrafters

3001-Z Southport Avenue, Chicago, Illinois, U.S.A.

Cable Address: "LIKEX NEW YORK"

We can show you the New 1936 SUPER SKYRIDER

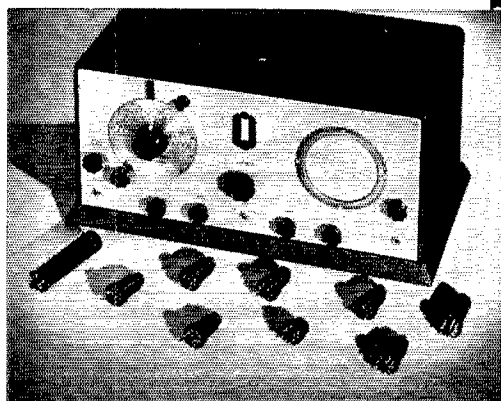

From the Hallicrafters Laboratories of Precision comes this new kind of radio, a worthy successor to the highly popular and successful 1935 Sky rider. Built to the same high standards of quality that have won the enthusiastic endorsement of its users everywhere, it gains by comparison with its predecessor by virtue of its superior performance and the new features which Hallicrafter engineers have incorporated into its design. We believe it is today's outstanding value in short-wave receivers, worthy to bear the Hallicrafters signature.

Among the new features that contribute to its truly brilliant performance are the following:

- **Metal Tubes** — elimination of noisy, unsatisfactory tube shields, reduced inter electrode capacities and shorter leads, making possible greater gain and fewer circuit complications.
- **Iron-Core I.F. System** — especially designed for the 1936 Super SKYRIDER — used for the first time commercially in any amateur receiver — having greater sensitivity and signal to noise ratio unattainable with an air core system.
- **More efficient Antenna Circuit** — better 5-band coverage of all-wave bands from 7.4 to 550 meters (41000 to 540 K.C.) made possible by tuning to the low-frequency end of each band.
- **Duo-Micro-Vernier Band Spread** — providing improved accuracy of logging — combines electrical band spreading and micro vernier tuning in an exclusive and distinctive dial with novel illumination.
- **Crystal Filter Circuit**, controlled by a variable knob on front of set, gives one-signal selectivity — without reducing sensitivity!
- **A Dozen other features** contribute to the exceptional accuracy and precision of performance, that must be reviewed before the 1936 Super SKYRIDER is fully appreciated.

See it at our store or write for literature

SUPER-SKYRIDER, complete with 9 metal tubes . . . \$79.50
 With crystal (model SX9) 89.50
 SUPER-7 complete with tubes 49.50

SHIPPED PREPAID If full purchase price
 accompanies your order

MARINE RADIO COMPANY

Eastern Distributors

124-11 101st Avenue Richmond Hill, New York
 Telephone: CLeveland 3-2400. Cable Address: "Elecmarine."

We Want You to See the New 1936 SUPER SKYRIDER

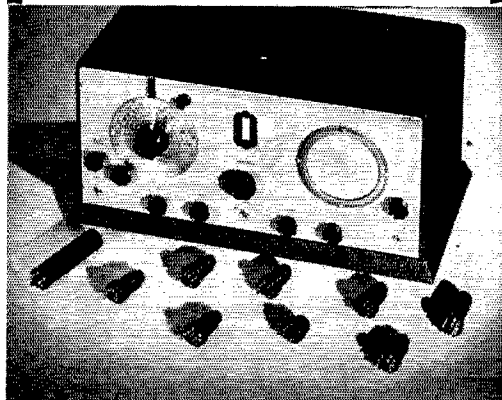

WE will be glad to show it to you

RADIO ACCESSORIES

OMAHA, NEBRASKA

HOW IS YOUR SUPPLY OF IDEAS?

If they ever run low, make sure that you have a copy of HINTS & KINKS handy. It is chock full of money-saving ideas and stunts of interest to you. There are many times when you will find it invaluable. The price is 50c post-paid.

AMERICAN RADIO RELAY LEAGUE

West Hartford

Connecticut

We are proud to offer the NEW 1936 SUPER SKYRIDER

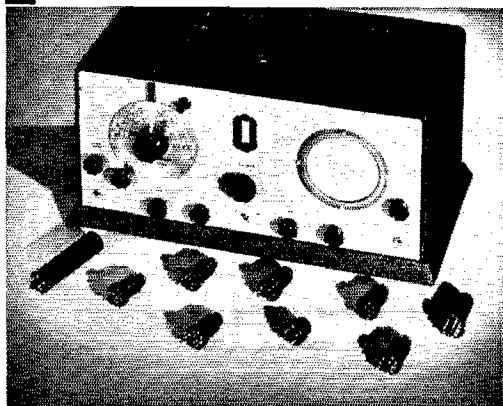

● From the Hallicrafters Laboratories of Precision comes this new kind of radio, a worthy successor to the highly popular and successful 1935 Sky Rider. Built to the same high standards of quality that have won the enthusiastic endorsement of its users everywhere, it gains by comparison with its predecessor by virtue of its superior performance and the new features which Hallicrafters engineers have incorporated into its design. We believe it is today's outstanding value in short-wave receivers, worthy to bear the Hallicrafters signature.

Among the new features that contribute to its truly brilliant performance are the following:

● Metal Tubes — elimination of noisy, unsatisfactory tube shields, reduced interelectrode capacities and shorter leads, making possible greater gain and fewer circuit complications.

● Iron-Core I.F. System — especially designed for the 1936 Super SKYRIDER — used for the first time commercially in any amateur receiver — having greater sensitivity and a signal-to-noise ratio unattainable with an air core system.

● More efficient Antenna Circuit — better 5-band coverage of all-wave bands from 7.4 to 550 meters (41000 to 540 K.C.) made possible by tuning to the low frequency end of each band.

● Duo-Micro-Vernier Band Spread — providing improved accuracy of logging — combines electrical band spreading and micro vernier tuning in an exclusive and distinctive dial with novel illumination.

● Crystal Filter Circuit, controlled by variable knob on front of set, gives one-signal selectivity — without reducing sensitivity!

A dozen other features contribute to the exceptional accuracy and precision of performance, that must be reviewed before the 1936 Super SKYRIDER is fully appreciated.

**COME IN AND SEE IT, OR . . .
WRITE FOR FULL INFORMATION . . .**

**Sold at a Price that makes it an outstanding value. List Price \$135.00.
Your Price \$79.50**

OFFENBACH ELECTRIC CO.

1452 MARKET STREET
SAN FRANCISCO CALIFORNIA

We offer the NEW 1936 SUPER SKYRIDER

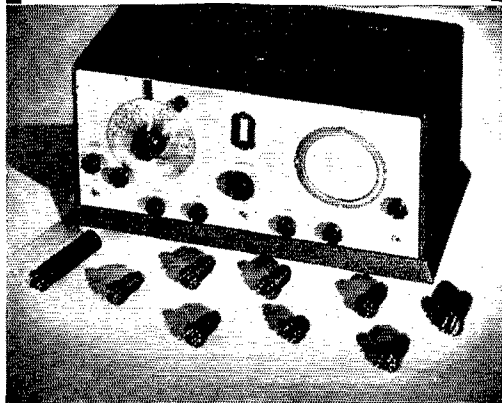

● From the Hallicrafters Laboratories of Precision comes this new kind of radio, a worthy successor to the highly popular and successful 1935 Sky Rider. Built to the same high standards of quality that have won the enthusiastic endorsement of its users everywhere, it gains by comparison with its predecessor by virtue of its superior performance and the new features which Hallicrafters engineers have incorporated into its design. We believe it is today's outstanding value in short-wave receivers, worthy to bear the Hallicrafters signature. Among the new features that contribute to its truly brilliant performance are the following:

● Metal Tubes — elimination of noisy, unsatisfactory tube shields, reduced interelectrode capacities and shorter leads making possible greater gain and fewer circuit complications.

● Iron-Core I.F. System — especially designed for the 1936 Super SKYRIDER — used for the first time commercially in any amateur receiver — having greater sensitivity and a signal-to-noise ratio unattainable with an air core system.

● More efficient Antenna Circuit — better 5-band coverage of all-wave bands from 7.4 to 550 meters (41000 to 540 K.C.) made possible by tuning to the low frequency end of each band.

● Duo-Micro-Vernier Band Spread — providing improved accuracy of logging — combines electrical band spreading and micro-vernier tuning in an exclusive and distinctive dial with novel illumination.

● Crystal Filter Circuit, controlled by variable knob on front of set, gives one-signal selectivity — without reducing sensitivity!

A Dozen other features contribute to the exceptional accuracy and precision of performance, that must be reviewed before the 1936 Super SKYRIDER is fully appreciated.

*Come in to see it or
Write for full information*

List Price \$135.00 Your Price \$79.50
Time Payments Only — \$13.50 Down, Balance Seven Easy Payments

HINDS & EDGARTON

19 South Wells Street
CHICAGO ILLINOIS, U.S.A.

Cat. No. 467-421
Sealed in rectangular
case. Convenient
chassis mounting and
wiring. Size $2\frac{3}{4}'' \times 2\frac{3}{8}''$
 $\times 4\frac{1}{8}''$ high. Wt. $2\frac{1}{2}$
lbs. List price \$8.00.

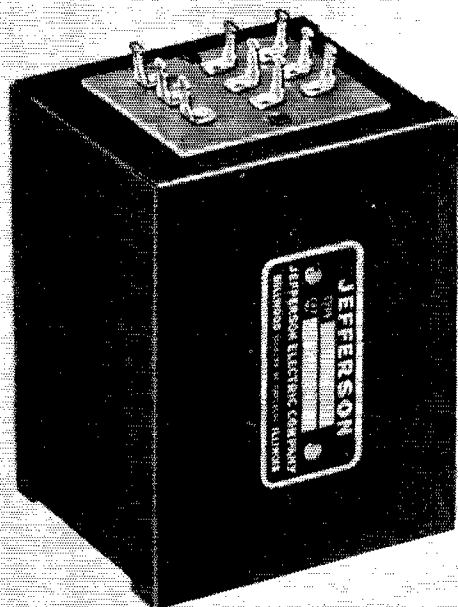

A Humless Jefferson Microphone and Coupling Transformer

WHAT do we mean by "HUMLESS"? Just this — the JEFFERSON Catalog No. 467-421 Microphone Transformer is designed on a new and improved principle. It has balanced windings assembled on an alloy core (hydrogen annealed high permeability nickel alloy). In spite of heavy shielding, the ordinary microphone transformer will pick up hum which is then amplified through the whole audio system. In this

new Jefferson Transformer, all hum is balanced out and cancelled — cannot reach the speaker. This transformer can be mounted on the chassis of a high gain amplifier without hum pickup.

The windings are also provided with taps to match 50, 100, 200 or 500 ohm lines to single or push-pull grids.

In performance, in convenience, in quality it is what you have been looking for.

A MICROPHONE TRANSFORMER FOR EVERY NEED

| Catalog Number | For Coupling | Size | Wt. Lbs. | Price |
|----------------|---------------------------------------|--|----------------|--------|
| 467-439 | Telephone Mike (75 Ohms) to Grid | 2 x $3\frac{1}{4}''$ x $1\frac{7}{8}''$ | 1 | \$1.30 |
| 467-413 | Single Button (200 Ohms) to Grid | 2 x $3\frac{1}{4}''$ x $1\frac{7}{8}''$ | 1 | 1.30 |
| 467-429 | Velocity (Ribbon) to 50/200 Ohms | $1\frac{5}{8}''$ x 3 x $1\frac{7}{8}''$ | $\frac{3}{4}$ | 1.40 |
| 467-414 | Double Button (200-0-200) to Grid | 2 x $3\frac{1}{4}''$ x $1\frac{7}{8}''$ | 1 | 1.90 |
| 467-261 | Single Button (200 Ohms) to Grid | $2\frac{1}{2}''$ x $2\frac{7}{8}''$ x $2\frac{7}{8}''$ | $1\frac{1}{2}$ | 2.00 |
| 467-263 | Double Button (200-0-200) to Grid | $2\frac{1}{2}''$ x $2\frac{7}{8}''$ x $2\frac{7}{8}''$ | 1 | 2.65 |
| 467-430 | Double Button to Line 50/200/500 Ohms | $2\frac{1}{2}''$ x $2\frac{7}{8}''$ x $2\frac{7}{8}''$ | $1\frac{1}{2}$ | 2.50 |
| 467-431 | Velocity (Ribbon) to 50/200 Ohms | $2\frac{1}{2}''$ x $2\frac{7}{8}''$ x $2\frac{7}{8}''$ | $1\frac{1}{2}$ | 4.00 |
| 467-432 | Double Button to Line 50/200/500 Ohms | $3\frac{1}{2}''$ x $2\frac{7}{8}''$ x $3\frac{1}{2}''$ | $2\frac{1}{2}$ | 3.75 |
| 467-262 | Double Button (200-0-200) to Grid | $3\frac{1}{2}''$ x $2\frac{7}{8}''$ x $3\frac{1}{2}''$ | $2\frac{1}{2}$ | 8.00 |
| 467-421 | Double Button (200-0-200) to Grid | $2\frac{3}{4}''$ x $2\frac{3}{8}''$ x $4\frac{1}{8}''$ | $2\frac{1}{2}$ | |

Write
YOUR
WHOLESALE
TODAY FOR
JEFFERSON
RADIO
CATALOG

JEFFERSON ELECTRIC COMPANY, Bellwood (Suburb of Chicago), Illinois
Canadian Factory: 535 College Street, Toronto

JEFFERSON *Radio* **Transformers**

Section Communications Managers of the A.R.R.L. Communications Department

All appointments in the League's field organization are made by the proper S.C.M., elected by members in each Section listed. Mail your S.C.M. (on the 10th of each month) a postal covering your radio activities for the previous 30 days. Tell him your DX, plans for experimenting, results in 'phone and traffic. He is interested, whether you are an A.R.R.L. member or get your QST at the newsstands; he wants a report from every active ham. If interested and qualified for O.R.S., O.P.S. or other appointments he can tell you about them, too.

| | | | | |
|---|---------------------------------|---|--|--|
| Eastern Pennsylvania | W3EZ | ATLANTIC DIVISION James M. Bruning | 339 W. Lancaster Ave. | Haverford |
| Maryland-Delaware-District of Columbia | W3BAK W3ZX W8DSP W8CUG | Edgar L. Hudson Carroll D. Kentner Don Farrell C. H. Grossarth | 1107 Park Ave. 213 Hickok Ave. 261 N. Balph Ave. | Laurel, Delaware Collingswood Syracuse Emsworth |
| Illinois | W0WR | CENTRAL DIVISION Fred J. Hinds | 6618 West 34th St. | Berwyn |
| Indiana | W0TE | Arthur L. Braun | 5211 Brookville Rd. | Indianapolis |
| Kentucky | W9AUH | G. W. Mossbarger | Box 177 | Camp Taylor |
| Michigan | W8DYH | Kenneth F. Conroy | 18030 Waltham Ave. | Detroit |
| Ohio | W8CJO | Robert P. Irvine | 5508 Northcliffe Ave. | Cleveland |
| Wisconsin* | W9ATO | E. A. Cary | 3397A N. 23 St. | Milwaukee |
| North Dakota | W9OFL | DAKOTA DIVISION Hartwell B. Burner | 601 S. Grange Ave. | Hope |
| South Dakota | W9PFI | Mike G. Strahon | 1200 Fauquier St. | Sioux Falls |
| Northern Minnesota* | W9JIE | R. C. Harsinberger | W. Bluff St. | St. Paul, Minnesota |
| Southern Minnesota | W9DEI | Francis C. Kramer | | St. Charles |
| Arkansas | W5ABI | DELTA DIVISION H. E. Velte | 2918 West 15th St. | Little Rock |
| Louisiana | W5DWV | W. J. Wilkinson, Jr. | 1624 Allen Ave. | Shreveport |
| Mississippi | W5CWO | J. L. Weems, Jr. | P. O. Box 244 | State College |
| Tennessee | W4BBT | Merrill B. Parker, Jr. | 1912 Oak St. | Chattanooga |
| Eastern New York | W2LU | HUDSON DIVISION Robert E. Haight | 511 South Holmes St. | Sootia |
| N. Y. C. & Long Island | W2AZV | E. L. Baunach | 7823 10th Ave. | Brooklyn |
| Northern New Jersey | W2FOP | Charles J. Hammersen | 92 Claremont Ave. | Verona |
| Iowa | W9LEZ | MIDWEST DIVISION Phil D. Boardman | 325 Kirkwood Blvd. | Davenport |
| Kansas | W9FLG | O. J. Spetter | 305 Western Ave. | Topeka |
| Missouri* | W9CJR | J. Dewey Mills | Green St. | Mount Vernon |
| Nebraska | W9FAM | Samuel C. Wallace | | Clarks |
| Connecticut | W1CTI | NEW ENGLAND DIVISION Frederick Ellis, Jr. | 19 Merrill Rd. | Norwalk |
| Maine | W1CDX | John W. Singleton | 73 Allen St. | Wilton |
| Eastern Massachusetts | W1ABG | Albert N. Giddis | 128 Crawford St. | Lowell |
| Western Massachusetts | W1BYR | Percy C. Noble | 37 Broad St. | Westfield |
| New Hampshire | W1AVJ | Robert Byron | 12 Humphrey St. | Concord |
| Rhode Island | W1HRC | Clayton C. Gordon | 206 California Ave. | Providence |
| Vermont | W1ATF | Harry Page | R. 1 | Hinesburg |
| Alaska | K7PO | NORTHWESTERN DIVISION Richard J. Fox | Box 301 | Ketchikan |
| Idaho | W7NH | Nellie H. Hart | Box 6 | Twin Falls |
| Montana | W7AAT | O. W. Viere | Box 265 | Red Lodge |
| Oregon | W7AMF | Frank L. Black | 1502 McPherson St. | North Bend |
| Washington | W7LDM | Niilo E. Koski | 5822 E. Green Lake Way | Seattle |
| Hawaii | K6FWQ | PACIFIC DIVISION Atlas O. Adams | 21st Infantry Brigade | Schofield Barracks |
| Nevada | W6BIC | Edward W. Helm | 716 West Sixth St. | Reno |
| Los Angeles | W6BPU | Howell C. Brown | 120 N. El Molino Ave. | Pasadena |
| Santa Clara Valley | W6BMW | Charles J. Camp | 318 Hawthorne Ave. | Palo Alto |
| East Bay | W6JTV | Harold J. Burchfield | 2940 106th Ave. | Oakland |
| San Francisco | W6SG | Alan D. Whittaker, Jr. | 78 Elinor Ave. | Mill Valley |
| Sacramento Valley | W6DVE | Ced. Woodington | 716 Redwood Ave. | North Sacramento |
| Arizona | W6LVG | C. C. Day | "La Posta Quemada" | Vail |
| Philippines | KA1XA | Newton E. Thompson | P. O. Box 849 | Manila, P. I. |
| San Diego | W6EOP | Harry A. Ambler | 4101 Hamilton St. | San Diego |
| San Joaquin Valley | W6CRF | Vernon C. Edgar | 732 Blackstone Ave. | Fresno |
| North Carolina | W4OG | ROANOKE DIVISION H. S. Carter | 115 Crafton St. | Winston-Salem |
| Virginia | W3BRY | Neil E. Henry | 1017 Knight St. | Lynchburg |
| West Virginia | W8KKG | Dr. Wm. H. Riheldaffer | | Lost Creek |
| Colorado | W9FA | ROCKY MOUNTAIN DIVISION Glen Glasscock | 1171 Detroit St. | Denver |
| Utah-Wyoming * | W6GQC | Arty W. Clark | 260 So. 9th West | Salt Lake City, Utah |
| Alabama | W4KP | SOUTHEASTERN DIVISION L. D. Elwell | 1066 Waverly St. | Tarrant |
| Eastern Florida | W4BCZ | Philip A. McMasters | 731 Arlington Ave. | St. Petersburg |
| Western Florida | W4MS | Edward J. Collins | 1517 East Brainard St. | Pensacola |
| Georgia-So. Carolina-Cuba- Isle-of-Pines-Porto Rico- Virgin Islands | W4CE | Bannie L. Stewart | SC-P53, C.C.C. Camp Lawrence | Effingham, S. C. |
| Northern Texas | W5BH | WEST GULF DIVISION Richard M. Cobb | Box 185 | Dodd City |
| Oklahoma | W5CEZ | Carter L. Simpson | 2010 So. 4th St. | Ponca City |
| Southern Texas | W5ADZ | Bradfield A. Beard | 2030 Quenby Road | Houston |
| New Mexico | W5CGJ | Joseph M. Eldodt | | Chamita |
| Maritime | VE1DQ | MARITIME DIVISION A. M. Crowell | 69 Dublin St. | Halifax, N. S. |
| Ontario | VE3GT | ONTARIO DIVISION S. B. Trainer, Jr. | 4 Shorncliffe Ave. | Toronto |
| Quebec | VE2EE | QUEBEC DIVISION Stan Comach | 780 Brault Ave. | Verdun, P. Q. |
| Alberta | VE4GD | VANALTA DIVISION J. Smalley, Jr. | 611 1st Ave., N. W. | Calgary |
| British Columbia | VE5AC | R. K. Town | 1754 Graveley St. | Vancouver |
| Manitoba | VE4BG | PRAIRIE DIVISION A. J. R. Simpson | 71 Thelmo Mansions | Winnipeg |
| Saskatchewan | VE4EL | Wilfred Skafte | 2040 McTavish St. | Regina |

* Officials appointed to act until the membership of the Section choose permanent S.C.M.'s by nomination and election.

The American Radio Relay League



• **T**HE AMERICAN RADIO RELAY LEAGUE, INC., is a non-commercial association of radio amateurs, bonded for the promotion of interest in amateur radio communication and experimentation, for the relaying of messages by radio, for the advancement of the radio art and of the public welfare, for the representation of the radio amateur in legislative matters, and for the maintenance of fraternalism and a high standard of conduct.

It is an incorporated association without capital stock, chartered under the laws of Connecticut. Its affairs are governed by a Board of Directors, elected every two years by the general membership. The officers are elected or appointed by the Directors. The League is non-commercial and no one commercially engaged in the manufacture, sale or rental of radio apparatus is eligible to membership on its board.

"Of, by and for the amateur," it numbers within its ranks practically every worth-while amateur in the nation and has a history of glorious achievement as the standard-bearer in amateur affairs.

Inquiries regarding membership are solicited. A bona fide interest in amateur radio is the only essential qualification; ownership of a transmitting station and knowledge of the code are not prerequisite. Correspondence should be addressed to the Secretary.

DIRECTORS

President
HIRAM PERCY MAXIM.....W1AW
Box 216, Hartford, Conn.

Vice-President
CHARLES H. STEWART.....W3ZS
St. David's, Pa.

Canadian General Manager
ALEX REID.....VE2BE
169 Logan Ave., St. Lambert, P. Q.

Atlantic Division
EUGENE C. WOODRUFF.....W8CMP
234 W. Fairmount Ave., State College, Pa.

Central Division
EDWARD A. ROBERTS.....W8HC
2699 Endicott Rd., Shaker Heights, Cleveland

Dakota Division
CARL L. JABS.....W9BVH
1822 James St., St. Paul, Minn.

Delta Division
M. M. HILL.....W5EB
P. O. Box 14, Natchitoches, La.

Hudson Division
KENNETH T. HILL.....W2AHC
115 Willow St., Douglaston, L. I., N. Y.

Midwest Division
H. W. KERR.....W9DZW-W9GP
Little Sioux, Iowa

New England Division
G. W. BAILEY.....W1KH
74 Webster Road, Weston, Mass.

Northwestern Division
RALPH J. GIBBONS.....W7KV
3933 N. E. 76th Ave., Portland, Ore.

Pacific Division
S. G. CULVER.....W6AN
2962 Russell St., Berkeley, Calif.

Roanoke Division
H. L. CAVENESS.....W4DW
State College Station, Raleigh, N. C.

Rocky Mountain Division
RUSSELL J. ANDREWS.....W9AAB
1867 So. Lafayette St., Denver, Colo.

Southeastern Division
BENNETT R. ADAMS, JR.....W4APU
1512 Grove Place, Homewood, Ala.

West Gulf Division
WAYLAND M. GROVES.....W5NW
c/o Humble Pipe Line Co., Neches, Texas

OFFICERS

President.....HIRAM PERCY MAXIM, W1AW
Hartford, Connecticut

Vice-President.....CHARLES H. STEWART, W3ZS
St. David's, Pennsylvania

Secretary.....KENNETH B. WARNER, W1EH
West Hartford, Connecticut

Treasurer.....ARTHUR A. HEBERT, W1ES
West Hartford, Connecticut

Communications Mgr....F. EDWARD HANDY, W1BDI
West Hartford, Connecticut

General Counsel.....PAUL M. SEGAL, W3EEA
1010 Shoreham Building, Washington, D. C.

Address all general correspondence to the executive headquarters at West Hartford, Connecticut

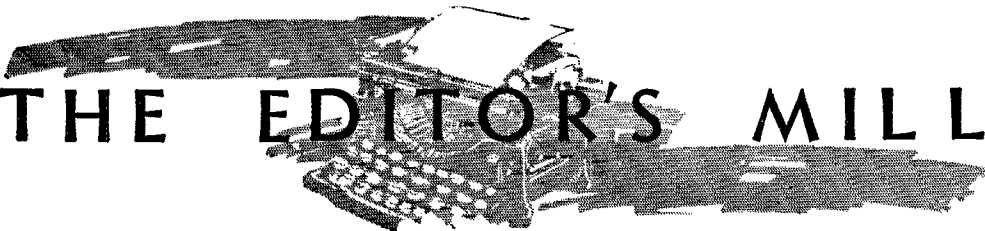

THE EDITOR'S MILL

WITH the solicitation of director nominations for the autumn elections, the membership of the A.R.R.L. welcomes into formal existence the new Southwestern Division consisting of southern California and the state of Arizona. They are electing their first director there this fall and with the coming of the first of the year they take their place with the other A.R.R.L. divisions as a unit in our League structure.

The enterprise of Californian amateurs is well known, but not every amateur realizes their number or the magnificent distances of the country in which they live. There are over five thousand licensed amateurs in California, more than in any other state of the union. Its two major cities of Los Angeles and San Francisco, though only half the length of the state apart, are separated by nearly five hundred miles, thirteen hours by rail. This is a separation that compares with that of Chicago and Memphis, of New York and North Carolina or of Washington and Savannah. With such a richness of amateur population and such a separation in distance and time, it is easy to see why the men in the southern part of the state wanted a division of their own. By the action of the last meeting of the Board, it now comes to pass.

For the last several years the Southwestern has been the scene of the activity of the Federation of Radio Clubs of the Southwest, A.R.R.L., an incorporated society grouping all of the many local clubs affiliated with the League in the Los Angeles region, and publishing its own monthly journal, *73*. A splendid organization, loyal to the ideals which have made A.R.R.L. great, it has been the largest contributing factor in the splendid development of amateur radio in that section of the country. Always one of the liveliest sections of A.R.R.L., the activity of the gang there may be attested by a look at any month's Operating News in *QST*.

A great big hand to you, Southwestern Division! Long may you radiate!

IN THE early days of broadcasting in this country, radio regulation broke down completely through the inadequacies of the existing law. The situation was further complicated by the desire of every service to make use of the new short waves, pioneered by amateurs. Congress was arguing the question of a new law, but

it was to be a good many years before it was written. No art ever went through a more trying period than did radio in the several years before the Radio Act of 1927 was enacted. In the interim, the organizing genius of Secretary of Commerce Hoover succeeded in establishing a defacto control of radio purely by the consent of the governed. Mr. Hoover in those years held a series of national radio conferences where the various groups in radio in this country practically wrote their own regulations, in a spirit of mutual conciliation, and agreed to abide by them.

Currently it is being argued by some critics of the League that the League made a fundamental mistake back in this period of ten to fifteen years ago, by not preserving for amateur radio the exclusive right to all of the frequencies from 1500 kilocycles to infinity. Reference is made to a printed statement of the Federal Radio Commission that the amateurs, speaking through their authorized representatives, gave up wavelengths for the commercial services. Some amateurs, we believe, are in a fair way to being led to believe that this was an official statement by the government that the representatives of the League willingly gave up our frequencies at the *international* conference which was held at Washington in 1927—the conference that reduced our bands to their present widths.

It is necessary, right off the bat, to make a distinction between these two kinds of Washington conferences. There was an international conference at Washington in 1927, but the reference here is to the series of four national radio conferences which Mr. Hoover held in the years preceding for the purpose of straightening out things strictly between the American radio interests. The quoted statement from the F.R.C. is a bouquet, a recognition of the common fairness of amateur radio in contenting itself, in those early days, with a series of wide and adequate bands which represented all that it and succeeding generations of amateurs could ever use! What the international conference subsequently did to these United States assignments is a completely different story.

It has been suggested that the action of Congress back in 1912, when it relegated amateurs and certain types of commercials to the "useless" wave lengths below 200 meters, unwittingly conspired to give us a sort of legal title to all the

wavelengths below 200 meters. Although the question was never adjudicated, we believe that it was true, from a strictly legal point of view, that we possessed a non-exclusive right to all the high frequencies; and the A.R.R.L. Board of Directors of that time was aware of that possible construction, through a brief that had been submitted by our counsel. But the grant, if such it was, was never exclusive to us. It was a specification of the upper wavelength limit for certain types of stations, ours included. Amateur radio never possessed the ability to exclude all other types of stations from all the frequencies above 1500 kc. Every service wanted some of the new short waves, and every service was legally and morally entitled to them. Moreover, the breakdown of the law had come about through a court ruling that the licensing authority had no discretion but had to grant licenses to every applicant. This was a first-class emergency and there was nothing for the administration to do but bring the American radio interests together and see if they could not arrive at some mutual agreements which they would respect. Amateur radio, through our Board of Directors, joined with the other radio services of the United States in these informal agreements during this period, and proud we are of the part we played and of the reputation for integrity that our group established by living up to our agreements. Our job was to get plenty of frequencies for ourselves. We got thoroughly adequate assignments. These assignments were from 1500 to 2000 kilocycles, from 3500 to 4000, from 7000 to 8000, from 14,000 to 16,000, from 28 to 32 megacycles and from 56 to 64 megacycles. Was that regarded as sufficient for amateur radio or did we believe we had been short-changed? You get the answer by asking yourself how you would like to see those bands assigned to-day to amateur radio! These frequency assignments endured until the international regulations of the international conference, a totally different breed of cats, went into effect. Even then our country was perfectly willing to continue them but was defeated by the majority vote of the nations participating in the international conference, and after 1929 was obliged to confine us to the "treaty bands."

Kansas State Convention

(Midwest Division)

October 5th and 6th, Hotel Kansan,
Topeka, Kans.

THE Kaw Valley Radio Club has been sponsoring so many conventions and they are such an established institution now that the mere announcement that a convention will be held at Topeka, Kans., at the Hotel Kansan, on October 5th and 6th is enough, except to again extend a

(Continued on page 100)

THE American Radio Relay League is twenty-one years old this year. Thus it has been engaged on behalf of the radio amateur since before many of to-day's amateurs were born, certainly before most of them dissected their first alarm clocks and decided to be engineers. Throughout that time it has been an organization of amateurs, by amateurs, for amateurs. Its prime aim, succinctly stated, has been to bring each one of us more security and more enjoyment in the pursuit of our art than we would have without joining hands in a League. The principal practical forms taken by this work have been the defense of amateur radio against unfair legislation and regulation and the provision of a means for collaboration in all matters of operating on the air, the actual use of stations. Of these, the first—the actual preservation of amateur radio—naturally has been of the greatest importance.

In an organization with as lengthy a history as A.R.R.L.'s, so many crises and emergencies have occurred in the defense of amateur radio that it is impossible to keep count of them. The history of the government's control of amateur radio is long and most complex. The permanent files of the League, with its record of participation in innumerable actions for amateur radio, running from minor skirmishes to major battles, fill twenty file cabinets. We live in the present and plan for the future, but there are in those records the story of many a battle now forgotten, thick files which show the stupendous effort amassed by the League in defense of an amateur right now taken for granted. The journal of the actions of the Board of Directors itself fills eight fat volumes in the secretary's safe. In them is the chronicle of the conscientious effort of the A.R.R.L. Board down through the years, dealing with the problems that confronted amateur radio at the moment, prescribing—as it always has done—what our policies should be to defend ourselves and to get what we wanted. Our present secure position speaks for itself of the wisdom of their works.

K. B. W.

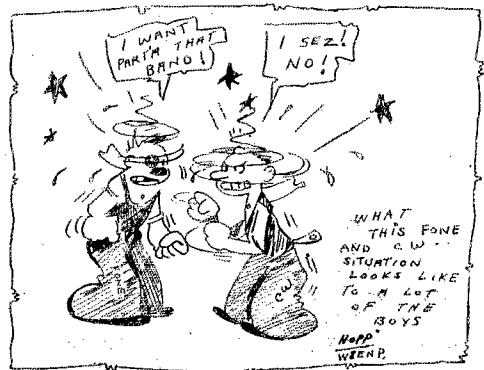

On Top of the U. S.

The Story of the Mt. Whitney 56-mc. QSO's

By Don C. Wallace, *W6AM

FIVE-METER amateurs think of the "Highest Mountain in U. S. A." with longing. For years there has been considerable discussion in Southern California about the possibility of someone making the trip to the top of Mt. Whitney and from there being able to talk with both San Francisco and Los Angeles.

The W6AM family enjoy mountain climbing and when the subject was suggested, they all enthusiastically welcomed the idea of climbing Mt. Whitney, the highest in the United States.

Careful preparation was necessary, because of the extreme altitude to be encountered. Previous experience indicated that if everything was handled carefully, it would be entirely possible to climb this high mountain and still be able to carry on 5-meter conversations while on the top. This, of course, meant complete and carefully planned equipment, for a total of nine or ten days would be spent on the expedition.

Mt. Whitney can be reached from either the west side or from the east side. While the west side has the more gradual slope, the climb takes several days, and has to originate in the Kern River country.

On the east side the trail is quite steep and quite long, but it is possible to reach the summit more quickly. We chose the east side.

We drove the 275 miles from Long Beach, California, to Hunters' Flats, 8300 feet high, on the first day, pitched our tent and made camp as comfortable as possible. This is the highest point that can be reached with an automobile.

Our two boys slept in the open in their sleeping bags. W6MA and Betty Jean slept in the tent. We stayed three days at the base camp in order to become acclimated to the altitude. By that time, we could breathe easily and perform normal tasks without undue exertion. Son Donald, age

*4214 Country Club Drive, Long Beach, Cal.

11, did considerable fishing and we were often privileged to samples of the delicious trout that he caught. I spent my time in making final checks on the equipment to be sure that everything was in first class shape.

Tests at home had indicated that the Johnson "Q" antenna, with its method of matching, was the surest way to success on 5 meters, so despite its bulk, a 5-Q was taken along. Up to that time, it had been impossible to find anyone who knew the general layout of the Smithsonian Institute Scientific Cabin on top. We found from the packers that it was full of snow and ice and could not be used, but that it was approximately 100 feet from the stone cabin to the monument which marked the very peak of Mt. Whitney. Accordingly, one hundred feet of feed line suitable for the 5-Q was made up from 18 standard fixture wire (which has approximately the same physical dimensions as 14 solid). Transposition blocks were used and the feed line rolled into a ball so it could be put up readily upon arrival at the top. 300 feet of extra wire, and 1000 feet of heavy cord were taken along as spare equipment—and all used. A spare set of tubes, two meters and some tools were also packed. With this equipment it would be possible to get the set on the air regardless of what happened to it in transit

Because of the severe conditions at the top of Mt. Whitney, the pack train people will not let any of their animals stay on top. No pack trains had been able to go up before the trip this year because of the heavy snows. This necessitated hiring a packer to bring the mule back as soon as we reached the top. We packed the mule light, because we wanted to pile wood on top of him at the

last possible place, otherwise we would have had no fire wood at the top. It was eight miles to the timber line from the top. These mountains are almost pure rock without a tree or plant in sight.



ONE OF THE BEAM ANTENNAS STRUNG OUT FROM THE MAIN 5-Q POLE

This shows that mountains existed as far as the eye could see. Note the rocks.

Around the 5-Q antenna (which was left in its original cardboard mailing tube) were wrapped numerous lengths of four-foot stick since there would be no poles available at the top. After climbing 14,502 feet, it would seem a shame not to get the fullest value from the set and antenna. We all know that some form of pole is necessary to do this.

After three days at Hunters' Flats, we packed up the mules and started up the trail. It took us but a few hours to reach a sort of a mountain meadow, 10,300 feet high, where the pack mule could graze and where we could stretch out in our sleeping bags and spend the night.

This, in a way, acclimated us to another height although we probably should have stayed at this second camp site another day or two.

The following morning we hit the trail and started up the long series of switchbacks over the Whitney pass. Everyone was able to keep right on walking but eventually our little girl tired and it was necessary to hoist her on our shoulders to give her a rest. She wouldn't hear of turning back so we kept on our way. It was a lot of work for us and slowed us down a great deal, but it did permit the entire family to keep on going to the top together.

Early that morning we passed three Boy Scouts

and pound equipment through the snow drifts ourselves. Since it was the latter part of July the snow drifts were melting and water made the trail pretty wet in spots and consequently, almost everyone finished the day's hiking with wet feet.

Upon arriving at the top, we found that the altitude made it impossible for most of the mem-



THE 5-METER EQUIPMENT TOGETHER WITH EXTRA RIBBON BATTERIES AND NUMEROUS FLASH LIGHTS AS USED ON THE ICE INSIDE OF THE CABIN

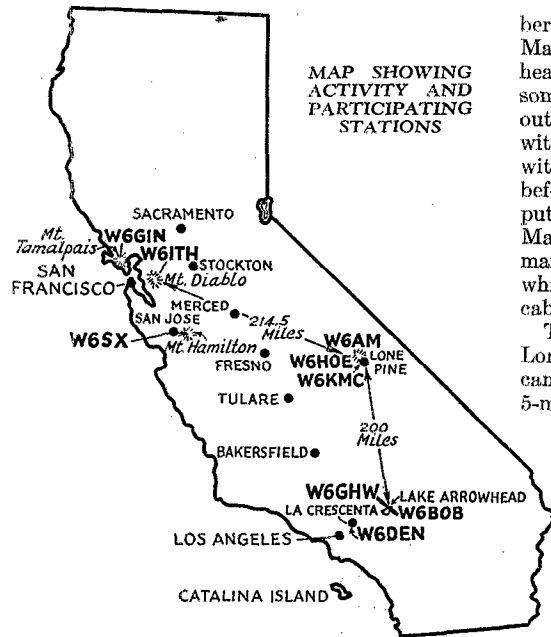

MAP SHOWING ACTIVITY AND PARTICIPATING STATIONS

who had spent the night at Mirror Lake, 10,600 feet high. They gradually caught up with us and true to the tradition of Boy Scouts, helped us out a great deal through the day.

When we reached the snowdrifts, we found that the pack mule would get stuck, so it was necessary to back him out, unload him and carry the 200

members of the party to do anything. The Scout Master took over the making of the fires, and the heating of stones. The altitude had its effect on some members of the party so we put them to bed, outside on the rocks, as the cabin was unlivable with snow, ice and water. We kept them warm with hot stones, tea and hot milk. It was 10 p.m. before it was possible to set up the radio set and put up the antenna. By this time even the Scout Master could hardly stand up, although he did manage to hold the flash light for a few minutes while the antenna was mounted on the roof of the cabin, using heavy cord as guy wires.

The first schedule was with W6HOE-W6KMC, Lone Pine, a town 26 miles away. Their signals came through in fine shape. We knew hundreds of 5-meter amateurs were on. The A.R.R.L. had sent out an official broadcast concerning the expedition and we had sent out about 250 letters to stations previously worked on 56 mc.

Following the QSO with W6HOE a station was heard and we called it, finally hooking up just before midnight. It proved to be W6GHW and W6BOB in the car of W6GHW with a mobile job near Lake Arrowhead, some 60 miles southeast of Los Angeles. W6BOB had received a letter about the expedition and had phoned W6AM at Long Beach to find out the best possible place to be. We discussed how well our plans had materialized and remarked that careful planning and preparation had made this 200 mile QSO possible. W6BOB was told that W6LFC had gone to

Catalina Island to climb the highest mountain there.

Shortly thereafter, W6BOB called W6LFC and they established the first authentic Catalina 56-mc. QSO to the mainland. We did not identify W6LFC's signals although six or eight stations could be heard, all of which were completely unreadable.

The set was operated continually until 5 a.m. but no other QSO's were possible. No other stations were heard loud enough to be readable with the exception of W6GHW, who was copied for about two hours.

As the sun rose, the family, bundled up in their blankets, sat out on the rocks and watched the gorgeous mountain sunrise.

That over, my main concern was to get the family and the Boy Scouts down the mountain, because the altitude was still bothering them. I accompanied them down the mountain a short distance, to a lower level, said good-bye and went back up to the top to continue the radio tests.

The original plan was to sleep in the day time and operate at night. Sleep seemed impossible, however, so I went on the air again and was very pleased to hook up immediately with W6ITH who had taken 1100 pounds of equipment up Mt. Diablo, just out of San Francisco. Mt. Diablo is rather a small hill to be called a mountain, as it is only 3800 feet high, but this established a new record for the Coast of 214.5 miles (figure furnished by the Department of Commerce).

W6ITH, with this 300-watt equipment came in R7 all afternoon but our QSO was rather indifferent as the W6AM signals reached him at a strength of R1 to R2. I understood everything he was saying to me, however, and the schedule went through in fine shape.

At the same time we also heard the Lick Observatory, W6SX, on Mt. Hamilton, out of San Jose. This is also a low mountain but the station at the Observatory is of considerable power. The signal strength from it was at least R8. Later on, W6SX wrote that his receiver was erratic that day and that the QRM from the many stations on in the Bay District and Peninsula prevented him from hearing weak signals.

Later on, interesting reports were received from a number of amateurs who had heard the Mt. Whitney transmitter, particularly a report

from W6GIN who had gone to the top of Mt. Tamalpais—Northwest of San Francisco and considerably farther than W6ITH. He had listened to the transmission of W6AM all Saturday night over a period of five hours and had called regularly. It is too bad that this QSO could not have gone through as it would have been pretty close to 300 miles.

Late Saturday afternoon, I was glad to hear from the family, who had just completed the trip down the mountain and were all sitting in the car at Hunters' Flats talking to me with the regular 50-watt mobile job in the car.

From then on, we had schedules three times a day, secured weather reports concerning the possible conditions of the weather on the trail and on one occasion we were advised by Mr. Cook not to come down the trail until conditions cleared.

Inasmuch as the batteries held up well, W6AM stayed on the top four days and three nights, operating almost all night each night. No other long distance QSO's were possible, due to the fact that the other amateurs did not stay up on the high locations after the first day.

The expedition showed the value of careful planning.

Both San Francisco and Los Angeles were worked, proving the possibility of a consistent relay link between Los Angeles and San Francisco on 56 mc.

The return trip was made by W6AM, less mule, carrying the sleeping bag, winter clothes and those parts of the radio set possible to carry. All batteries were left on top. I figured it would be just as easy to carry the equipment down, as to have the pack train come back up. The return hike was awfully hard, however, as the equipment weighed approximately eighty pounds and in the rarefied atmosphere was very hard to carry.

During the four days at the top, almost no food could be eaten and of course very little sleep is possible for a radio man. During the last twenty-four hours, no food at all was eaten and only a little bit of warm water was taken. No more than two or three days is recommended for future expeditions going to Mt. Whitney.

The dates of the expedition were July 23 to July 31 inclusive. The actual transmissions from the top occurred July 27, 28, 29 and 30.

The pack train company who have operated in these mountains state this is the first radio transmission from the top of Mt. Whitney.



BOY SCOUTS HELPING US THROUGH THE SNOW DRIFTS

The mule had to be unpacked, otherwise he got stuck.

The Equipment on the "Morrissey"

W10XFP's Improved C.W.-'Phone Transmitter

By Bob Moe,* W2UN

THIS summer amateurs all over the country heard the 'phone signals from W10XFP, the Schooner *Morrissey* (VOQ, VOQH and W10XDA of past trips), while she was in the Arctic. Many amateurs will be interested in knowing what equipment was being used. The original transmitter was completely described in the December 1934 issue of *QST*, but several changes have since been made and we are here giving a description of the present transmitter.

As we have mentioned before, the source of power is the most important problem on a ship. Realizing the convenience of 115-volt a.c. supply, we obtained a 600-watt Janette rotary converter which changes the 120-volt battery supply, obtained from a 60-cell bank of Exide XHR 117 batteries, to 115 volts a.c. This permits the use of

rather high and it is necessary to charge them several hours every day. To avoid unnecessary drain on the batteries the converter is run only while the transmitter is in operation. Therefore, the transmitter can only use tubes with directly-heated filaments, so that it will be in operation immediately upon starting the converter.

For those who missed the former description here is the complete line-up, briefly.

The crystal oscillator is completely shielded by an aluminum box to avoid r.f. feedback from the final amplifier on the shelf above. It uses a 47 tube and is coupled to the following stage by a 100- μ fd. midget variable condenser. Adjustment of this condenser is often desirable to get the correct excitation to the following stage.

The doubler, which uses a 46 tube with 22.5

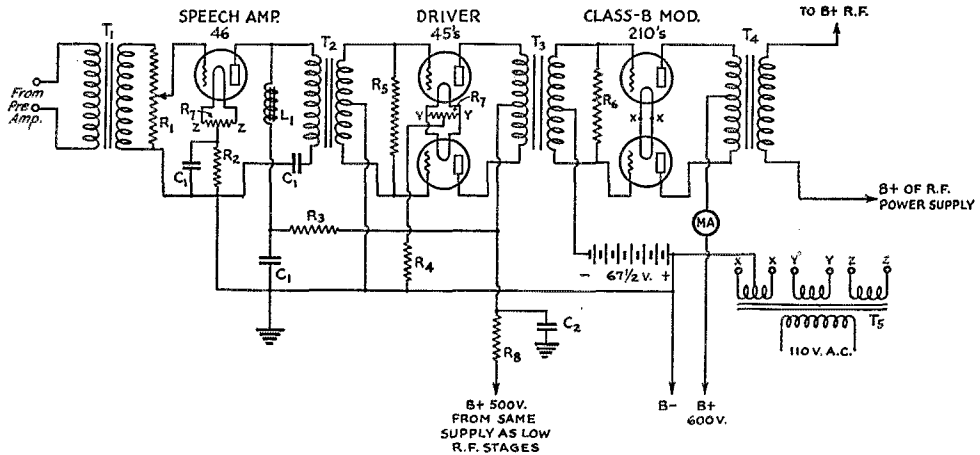

FIG. 1—SPEECH-AMPLIFIER AND MODULATOR

- C₁—2- μ fd. 300-volt condensers.
C₂—4- μ fd. 500-volt condenser.
L₁—30-henry choke (Thordarson R196).

- R₁—100,000-ohm volume control.
R₂—1500-ohm 25-watt resistor.
R₃—2000-ohm 25-watt resistor.
R₄—750-ohm 25-watt resistor.
R₅—200,000-ohm resistor 10-watt.

- R₆—20,000-ohm 10-watt resistor.
R₇—20-ohm center-tapped resistor.
R₈—2000-ohm 25-watt.
T₁—Input transformer, 500-ohm line to grid (Thordarson T6371).
T₂—Push-pull input trans-

- former (Amertran 151).
T₃—Class-B input transformer, 45's to 10's (Collins 715B).
T₄—Class-B output transformer, 10's to 6250-ohm load (Collins 781B).
T₅—Filament transformer 2½, 2½, 7½ volts.

power equipment similar to that used by most amateurs. The bank of batteries is charged by a Delco 1750-watt gas engine driven generator. This same bank of batteries also supplies current for all lights aboard the ship and runs a large size Frigidaire. All in all, the drain on the batteries is

* 562 79th St., Brooklyn, N. Y.

volts of battery bias is not neutralized and is always operated at twice the crystal frequency. We found it necessary to use the battery bias to prevent creeping plate current so common in this tube. An 865 tube is used in the next stage and replaces the neutralized 841 originally used in the transmitter. This stage may be used as a straight

r.f. amplifier or as a doubler. For 'phone work it should always be operated as a straight amplifier, because as a doubler it will not supply sufficient excitation to the final amplifier for correct operation.

During the two summers we have spent in the Arctic the only frequencies which we found it necessary to use were the 20-meter amateur band, the 23.3-meter experimental frequency, the 24-meter marine band, the 34.6-meter experimental frequency, the 36-meter marine band and the 40-meter amateur band.

amplifier, which is link-coupled to the 865 stage uses a single 203-A with a split-stator condenser in the plate circuit for neutralization. No adjustment of the neutralizing condenser is necessary when changing frequency.

The antenna on the ship is a 60-foot vertical wire, which runs from the top of the mainmast to the deck. It is held off at the top by a 12-foot yardarm, which holds it out clear from the rigging of the ship. A nine-foot lead connects it to the transmitter below. While making tests last year we noticed that the rigging of the ship was ab-

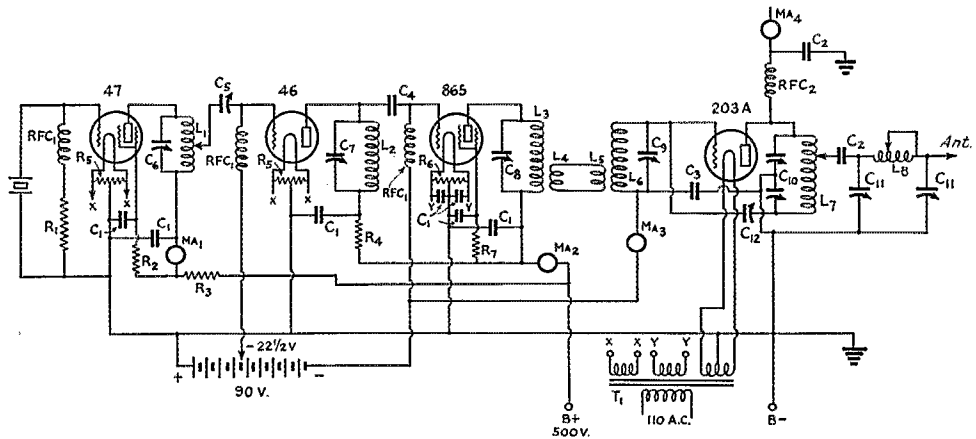

FIG. 2.—R. F. PORTION OF W10XFP

- C₁—0.002- μ fd. mica condenser.
- C₂—0.002- μ fd. mica condenser, 5000-volt rating.
- C₃—0.004- μ fd. mica condenser.
- C₄—100- μ fd. mica condenser.
- C₅—100- μ fd. midget condenser (Hammarlund MC-100-S).
- C₆—200- μ fd. midget condenser (Hammarlund MC-200-M).
- C₇—200- μ fd. transmitting condenser (Hammarlund TC-225-X).
- C₈—200- μ fd. transmitting condenser (Hammarlund TC-225-X).
- C₉—100- μ fd. transmitting condenser (Hammarlund TC-100-B).
- C₁₀—Split-stator transmitting condenser 100- μ fd. each section (Hammarlund TCD-100-A).
- C₁₁—250- μ fd. transmitting condenser (Hammarlund TC-225-A).
- C₁₂—30- μ fd. transmitting condenser (Hammarlund TC-30-A).
- L₁—18 turns No. 22 d.c.c. wire close-wound, tapped 7 turns from bottom.
- L₂—8 turns No. 20 d.c.c. wire spaced diameter of wire.
- L₃—12 turns No. 20 d.c.c. wire spaced diameter of wire.
- L₄—3 turns No. 20 d.c.c. wire on same form as L₃.
- L₅—4 turns No. 20 d.c.c. wire on same form as L₄.
- L₆—For 7 mc., 13 turns No. 20 d.c.c. wire spaced diameter of wire.

In order to facilitate frequency shifting, all these low level r.f. stages (47, 46, 865), were equipped with 200- μ fd. tuning condensers and it is now possible to operate these stages on any of the above frequencies without changing coils.

To insure high efficiency in the final amplifier both grid and plate coils are changed, one set of coils being used for 20, 23.3 and 24 meters, the other set for 34.6, 36 and 40 meters. The final

- For 14 mc., 6 turns No. 20 d.c.c. wire spaced diameter of wire.
- Above coils all wound 1½-inch diameter plug-in coil forms.
- L₇—For 7 mc., 15 turns ¼-inch copper tubing, diameter 3½ inches.
- For 14 mc., 10 turns ¼-inch copper tubing, diameter 2½ inches.
- L₈—15 turns No. 12 enamelled wire, spaced diameter of wire, wound on 2½-inch isolantite form, tapped every 5 turns.
- R₁—10,000-ohm 10-watt.
- R₂—50,000-ohm 10-watt.
- R₃—15,000-ohm 25-watt.
- R₄—5000-ohm 25-watt.
- R₅—20-ohm center-tapped resistor.
- R₆—50-ohm center-tapped resistor.
- R₇—20,000-ohm 25-watt resistor.
- RFC₁—Receiving type r.f. choke (Hammarlund CH-X).
- RFC₂—Transmitting type r.f. choke (Hammarlund CH-500).
- MA₁—0-50 milliammeter.
- MA₂—0-200 milliammeter.
- MA₃—0-100 milliammeter.
- MA₄—0-300 milliammeter.
- T₁—Filament transformer, 10-volt, 7½-volt, 2½-volt windings.

sorbing plenty of r.f. and that it was possible to light the bulb of an absorption wavemeter by holding it near the rigging, many feet from the antenna. We tried to install the antenna in a different place this year, but wherever we tried to put it, the ship's rigging, a swinging sail, a halyard or rope would be in the way; so we finally solved the problem by putting the antenna right back where it was. The transmitter, which operates on such a multiplicity of frequencies, is

coupled to this antenna by a single-line coupling unit such as described in *QST* for February, 1934.

Trouble with r.f. getting into the speech equipment usually occurs in the low-level audio stages. To eliminate any possibility of this, we built a two-stage pre-amplifier in an iron box, with self-contained batteries. The input and output of this preamplifier and the speech input connections of the transmitter are equipped with plugs such as

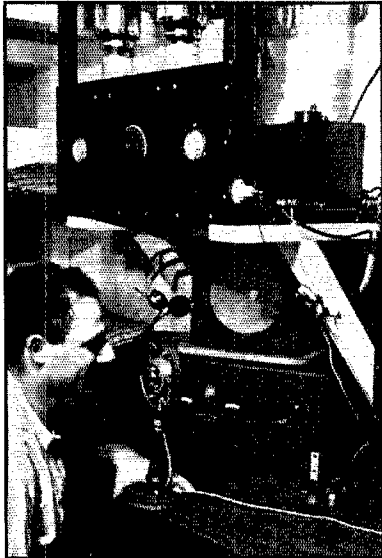

JULIUS ROSS, W2KJ, BEFORE THE MIKE ON W10XFP

are used in portable broadcast equipment and it is possible to feed the transmitter from any standard R.C.A. or W.E. portable broadcast amplifier. Our pre-amplifier uses two 230 tubes, which were chosen in preference to the 864 because of the lower battery drain. It feeds the transmitter through a 500-ohm line at a level of approximately -2 db.

Another advantage of this method of feeding the speech into the transmitter is that the mike and pre-amplifier can feed the transmitter from a distance without worry about r.f. getting into the line as is the case with long microphone cables. However, it is often necessary to ground one side of the 500-ohm line.

The first speech amplifier in the transmitter is a 46 tube with Class-A connections. This was necessary, as mentioned previously, because we must use a tube with a directly-heated filament. This tube is transformer-coupled to a pair of push-pull 45 tubes, which drive the modulator tubes—a pair of carbon plate 210's, which deliver 60 watts of audio power. The output transformer is a Collins 781B and is designed to work into a 6250-

ohm load. This load is obtained by operating the 203-A at 900 volts and 144 milliamperes.

Three power supplies are used, one 900-volt supply for the 203-A tube, a 600-volt supply for the carbon plate 210 modulator tubes, and a 500-volt supply which operates all the low-level r.f. and a.f. tubes. All are regular transformer, rectifier and filter arrangements familiar to every amateur. The 900-volt supply has a transformer with taps and it is possible to step the voltage up to 1250 or 1500 volts for c.w. work.

This writer wishes to thank all amateurs for their help and cooperation during the previous trips of the *Morrissey*. If plans now being made can be put through, it is quite possible that the *Morrissey* will be equipped with a 1-kw. transmitter next year. Realizing the excellent work done by the 100-watt transmitter now in use, we are anticipating big things from a high-power rig.

Coil Data for "All-Purpose" S.S. Superhet

WINDING specifications for the coils of the turret-type tuning system of the superhet receiver described in the August and September issues of *QST* are given in the following table:

| COIL TABLE | | | | |
|-----------------------------------|--------------|--------------|--------------|--------------|
| Band | 3.5 mc. | 7 mc. | 14 mc. | 28 mc. |
| L ₁ | 5 t. | 5 t. | 4½ t. | 4 t. |
| L ₂ and L ₄ | 34 t. | 19¾ t. | 12½ t. | 6 t. |
| To tap | 16¾ t. | 5½ t. | 2½ t. | 1.1 t. |
| Size of wire | No. 22 enam. | No. 20 enam. | No. 18 enam. | No. 14 enam. |
| Length of winding | 1¾" | 1¼" | 1" | 1½" |
| L ₃ | 20 t. | 12 t. | 7¾ t. | 4 t. |
| L ₅ | 8½ t. | 6 t. | 4 t. | 4 t. |
| L ₆ | 26 t. | 16½ t. | 11½ t. | 11½ t. |
| Tap | 14.4 t. | 4½ t. | 2¼ t. | 3½ t. |
| Size of wire | No. 22 enam. | No. 20 enam. | No. 18 enam. | No. 18 enam. |
| Length of winding | 1¾" | 1¼" | 1¼" | 1¾" |

L₁ and L₃ for 28 mc. are wound between turns of L₂ and L₄.

L₅ is wound between turns of L₆ for all ranges.

L₁, L₃, L₅ are all wound with No. 34 d.c.c.

Tracking condenser C₇—

| | | | | |
|----------------|-------------|------------|--------|--------|
| Broadcast band | 3.5 mc. | 7 mc. | 14 mc. | 28 mc. |
| | .00035 µfd. | .0035 µfd. | .0095 | none |

3.5- and 7-mc. coils are 1½ inches in diameter

14- and 28-mc. coils are 1 inch in diameter

Delta Division Convention

October 19th and 20th, Hotel Pines, Pine Bluff, Ark.

JUST a few lines to the Delta Division amateurs extending them a cordial invitation to attend the annual convention to be held at the Hotel Pines, Pine Bluff, Ark. A good program is in preparation and from present indication we hope to have John L. Reinartz, W1QP, special repre-

(Continued on page 108)

What's in a Circuit?

A Discussion of Some Problems Encountered in Building a Simple Oscillator-Amplifier Transmitter

By George Grammer*

A COMPLETE circuit—transmitter, receiver or whatever it may be—actually is a combination of individual, more elementary circuits any of which often can be replaced by a slightly different one which theoretically will do the same job. For example, a transmitter diagram may show parallel plate feed to an oscillator or amplifier stage; there is no obvious reason why that part of the circuit should not be changed slightly so that series feed can be used. Or the constructor may have reasons for preferring one type of neutralizing system to another and accordingly make the appropriate substitution. Probably these changes are the rule rather than the exception when a piece of apparatus is built from a published description.

On the other hand, the original designer of the circuit may have had very good reasons for using just the particular arrangement recommended. Very often several circuits are tried before the final, most satisfactory version is reached, with individual circuit arrangements which for one reason or another did not give the best performance being discarded. In such a case, the unsuspecting builder who "duplicates" the circuit by using such parts of it as he wants and making substitutions where it pleases him, is likely to run into the very difficulties which the published circuit avoided.

The transmitter illustrated here is a case in point. The job on hand was that of constructing a transmitter relatively simple and compact—

* Asst. Technical Editor, QST.

since it had to fit into a space of limited dimensions—and having a moderate amount of power output for c.w. work on 7 and 14 megacycles. Quick and convenient band-changing was considered to be an especially desirable feature, indicating the use of tapped coils. In view of the fact that a miscellaneous collection of parts already on hand had to be used, the available space did not permit using more than two stages, with antenna-tuning equipment. It was therefore deemed advisable to use a fairly large tube and get as high a power amplification ratio as possible, rather than to attempt to push small tubes to the

limits of their capabilities. As a result, the tubes selected were a 47 and a 203-A, the former as a straight 7-mc. crystal oscillator and the latter as a neutralized amplifier on 7 mc. and a doubler on 14 mc. While this combination did not appear to be one which would give high amplifier plate efficiency, efficiency had to be relegated to a minor position in the face of the other requirements. It was expected, however, that a power output of the order of 50 or 75 watts could be secured without any particular difficulty.

With the tube lineup decided upon, the next question to be settled was that of

circuit details—coupling, neutralizing and antenna tuning.

THE FIRST ATTEMPT

Such a simple arrangement as a straight crystal oscillator and neutralized amplifier did not appear to offer very many possibilities for trouble, so a circuit which looked quite reasonable was

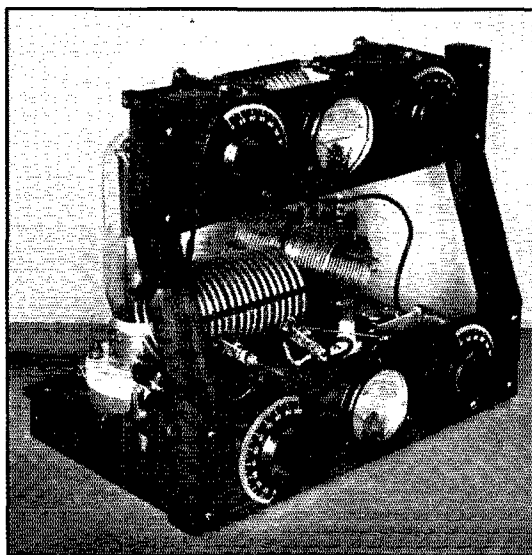

A FRONT VIEW OF THE TRANSMITTER DISCUSSED IN THE TEXT

This rig is built for c.w. work on the 7- and 14-mc. bands, and is intended to fit into a corner of a drop-leaf desk. It uses a 7-mc. pentode crystal oscillator and 203-A amplifier-doubler.

drawn up on paper. In laying out a circuit, past experience with similar rigs always is an important factor. Previous experience with the 203-A as an amplifier at high frequencies indicated the desirability of using a neutralizing circuit of the type having a split-stator condenser with grounded rotor, because of the reduction in input capacity typical of this sort of circuit. Also, since pentode oscillators are rather sensitive to loading, provision was made for readily-variable coupling between oscillator and amplifier so that optimum

without capacity-loading the oscillator, as shown by the heavy grid tap in Fig. 1A; or taken from the tuned portion in the more conventional fashion indicated by the dotted grid tap. Plenty of flexibility was provided by this arrangement.

Although this circuit looked to be quite logical on paper, an actual trial proved it to be unsatisfactory, for a reason which would not be apparent from inspection of the circuit alone. Because of the limited space available the effective tuning capacity of the split-stator tank condenser had to be quite small. To keep the condenser within allowable dimensions and maintain suitable plate spacing, the maximum condenser capacity that could be accommodated was about $50 \mu\text{fd}$. The condenser was, in fact, a 43-plate receiving condenser with alternate plates removed on both rotor and stator and with the stator split into two sections. These operations reduced the maximum capacity from original $1000 \mu\text{fd}$. to approximately $50 \mu\text{fd}$. Because of the relatively high capacity shunted across one section of the condenser by the 203-A tube and its associated apparatus, the capacity balance of the plate circuit was badly upset, with the result that although the tube could be neutralized properly for any given setting of the tank condenser, C_2 , a small change in the setting of C_2 would throw the circuit out of neutralization.¹ The inconvenience of reneutralizing every time a frequency change was made put this first circuit definitely out of the running.

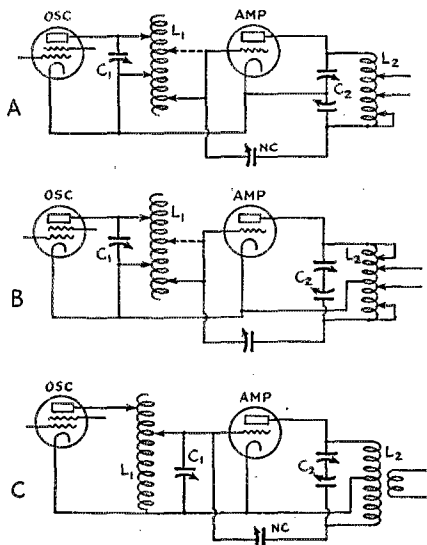

FIG. 1—EVOLUTION OF THE CIRCUIT

The same components are used in all three of the circuits shown and, on paper at least, all three should give the same performance. However, starting with the first circuit proposed, that at A, practical considerations which were not apparent before an actual trial forced several changes until the final circuit of C was worked out.

coupling could be determined from a few trial settings. To avoid the necessity for variable inductive coupling between antenna circuit and plate tank circuit, it was decided to use a link line between the two and adjust the coupling by taps at the center of the amplifier tank coil. The essentials of the tentative circuit are shown in Fig. 1A, minus those elements such as by-pass condensers and chokes which, although highly essential, do not enter into the present discussion.

From a mechanical standpoint, the variable interstage coupling was handled by making a space-wound coil of bare wire, using plenty of turns, with taps so that the oscillator plate condenser, C_1 , could be connected across any desired number of turns to take care of tuning and various L - C ratios. A third tap was provided for the amplifier grid excitation. Then by placing the "ground" or common cathode tap at some convenient point on the coil, the grid excitation could be taken off the untuned portion of the coil

NAILING DOWN THE NEUTRALIZATION

The obvious move to avoid capacity unbalance and thus keep the neutralizing fixed over the tuning range was to disconnect the condenser rotor from ground and move the ground connection to the center of the plate coil, L_2 , thereby making the circuit of Fig. 1B. From the neutralizing standpoint this was OK, and no particularly bad effects were suffered from the increase in input capacity since the interstage coupling could be readily adjusted to compensate for the extra capacity loading on the oscillator plate circuit. It became necessary, however, to use two taps instead of one on L_2 for band-changing because of the fact that the zero-potential point on the coil was no longer free to move, since the center of the coil was now definitely tied to ground. This was no disadvantage, however, since the coupling taps could remain symmetrical with the actual center of the coil, and therefore probably would need no readjustment when changing bands.

In going to this circuit we had, however, overlooked the fact that this particular combination of neutralizing and grid-coupling system is likely to be the cause of high-frequency parasitic oscillations, the coil turns between grid and filament and between plate and filament operating to

¹ See editor's note, page 39, June, 1934, QST.

make the tube oscillate in t.p.t.g. fashion.² The tube did not overlook this possibility, though, and insisted on oscillating only too well on some unknown frequency. The only sure-fire remedy we know for a parasitic oscillation of this type is to make certain that the coil turns between grid and filament in the amplifier circuit are prevented from acting independently. This can be done by shunting the tuning condenser across them. Accordingly the original idea of putting the oscillator across the tuned part of the circuit was abandoned; the condenser was connected across the turns between grid and filament of the amplifier and the oscillator plate tap moved up on the untuned portion of the coil L_1 to give the necessary step-down impedance ratio. This gave the circuit of Fig. 1C, which eliminated the last of the "bugs" and made the set behave as it should.

During the course of experimenting with different circuit combinations it was found that the coupling taps to the antenna circuit did not need to be across more than one turn of the plate tank coil. Since variable coupling was unnecessary, the taps were discarded entirely and a single coupling turn, placed inside L_2 at its center, was substituted, thus avoiding the use of an extra pair of clips.

KEYING

While the circuit changes were being made, another problem, that of keying, came into the picture. It had been intended originally to key the center-tap of the amplifier, leaving the oscillator to run continuously. A trial of this system did not give very pleasing results, however. Keying the amplifier center-tap opens and closes its grid circuit, with the result that the load on the oscillator changes with keying. This in turn causes the oscillator frequency to shift so that the frequency under key-down conditions differs from that under key-up conditions by a kilocycle or two. Thus the main wave and back wave are on two different frequencies, and although this may do no harm since the back-wave should not get through the neutralized amplifier, yet it does represent an undesirable condition. Furthermore, since the installation of some sort of thump filter usually is necessary with center-tap keying, the time lag introduced by such a filter easily could cause a chirp. The alternative of keying the negative amplifier plate return alone, thus maintaining a fairly constant load on the oscillator,

²"Circuits Within Circuits," June, 1933, *QST*.

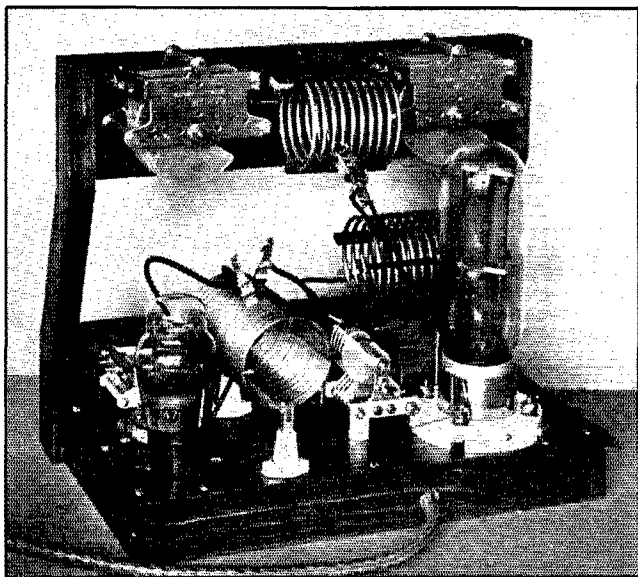

THIS REAR VIEW SHOWS THE ARRANGEMENT OF PARTS ON THE BASE AND PANELS

The oscillator coil, at the left, is placed so that coupling between it and the amplifier plate and antenna coils is minimized. Points at high r.f. potential are insulated from the wooden base by porcelain stand-offs.

was discarded because of its still greater tendency toward thumps and sparking at the key contacts.

It was therefore decided to give oscillator keying a trial, so the key was put in the oscillator filament center-tap. A quick check showed that the oscillator would follow rapid keying readily enough, but a very pronounced chirp developed. At this time the oscillator screen voltage was being supplied through a 50,000-ohm dropping resistor. The scheme of using a voltage divider, as outlined in April *QST*,³ was therefore introduced; the chirps disappeared and keying was no longer a problem. Keying the oscillator brings with it all the advantages of break-in operation.

THE FINAL CIRCUIT

For the benefit of those who may wish to build an outfit along the same lines, the complete circuit diagram as finally worked out is shown in Fig. 2. Parallel plate feed is used on both tubes to keep the high voltage off the coils, which naturally have to be handled when taps are changed. The antenna tuning circuit, $C_3L_3C_4$, is arranged for series tuning of Zepp feeders, the coil L_3 being proportioned so that the condensers will hit resonance on both 7 and 14 mc. with feeders approximately 45 feet long.

The circuit shown in Fig. 2 is arranged so that bias for the amplifier can be obtained from a voltage divider across the plate supply for the oscillator. The condenser C_{11} serves both as an

³"Chirpless Keying with Pentodes," Experimenters' Section, April, 1935, *QST*.

insulating condenser between the two filament circuits and as a by-pass for the amplifier grid bias. Those not familiar with the connections used in this type of biasing will find the details of the arrangement in Fig. 3. The proper connections for keying and for filament returns will be found in Fig. 2.

The somewhat odd appearance of the set itself is accounted for by the fact that it was built to fit into a corner of a desk having a drop leaf, the front of the set being sloped so that it would fit in the desk with the leaf closed. The open space

insulators with its axis running from front to rear. The crystal plugs into a wafer socket just behind the oscillator tuning condenser, C_1 , which is at the right on the lower panel. The amplifier plate coil, L_2 , of the same general type of construction as L_1 , is mounted directly on the amplifier tank condenser, C_2 . The ends of the $\frac{1}{2}$ -inch copper tubing are sweated into terminal lugs made from $\frac{3}{16}$ -inch tubing, these in turn being fastened to the stator-plate terminal screws. The lower-most bakelite coil strip rests directly on the tank condenser frame. The amplifier plate blocking condenser, C_{12} , is mounted directly alongside C_2 , and is supported by the bus wire which connects it to C_2 and the plate terminal on the 203-A socket. The neutralizing condenser, C_{13} , is mounted on a small stand-off and is placed on the base midway between the rear end of L_1 and the 203-A socket.

The antenna tuning condensers and coil, L_3 , are mounted on the upper panel. The antenna coil, which is wound with $\frac{1}{8}$ -inch tubing and fitted with copper-tubing lugs similar to those used on the tank coil, is suspended between the two condensers, the connections being made to the condenser frames. The clips from the coupling link are normally connected across two turns of the antenna coupling coil.

Resistors, chokes and by-pass condensers are underneath the base, as shown in the bottom-view photograph. At the upper left in this view is the socket for the 47; above it the pair of midget fixed condensers which serve as filament by-passes. Below the 47 socket is the 5-prong socket for the crystal holder. The screen by-pass condenser is mounted on the side support. The oscillator grid choke is directly over the crystal socket; its lower end is connected to the grid leak, which is placed horizontally just above the oscillator tuning condenser projecting through the baseboard. One end of oscillator plate choke is soldered directly to the plate terminal on the tube socket, and its other end is supported on a midget porcelain stand-off. The plate blocking condenser, C_7 , is directly below this choke in the photograph. The by-pass condenser with the two cable connections is C_{11} ; R_3 is mounted alongside this condenser and R_2 above it. At the right-hand

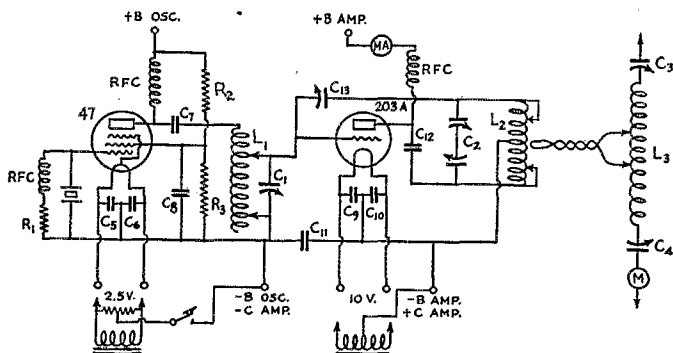

FIG. 2—THE COMPLETE CIRCUIT DIAGRAM

This is equivalent to the skeleton circuit "C" of Fig. 1.

- C_1 —100- μ fd, variable condenser, receiving type.
- C_2 —Split-stator condenser, double-spaced, 100 μ fd, each section; total capacity, 50 μ fd.
- C_3, C_4 —350- μ fd, variables, receiving type.
- C_5, C_6 —0.002- μ fd, fixed mica condensers.
- C_7 —100- μ fd, fixed mica condenser.
- C_8 —0.002- μ fd, fixed mica condenser.
- C_9, C_{10} —0.005- μ fd, fixed mica condensers.
- C_{11} —0.002- μ fd, fixed mica condenser.
- C_{12} —500- μ fd, fixed mica condenser, 5000-volt rating.
- C_{13} —25- μ fd, variable, transmitting type.
- R_1 —5000 ohms, non-inductive, 2-watt.
- R_2 —50,000 ohms, 2-watt.
- R_3 —20,000 ohms, 2-watt.
- RFC—Short-wave sectional-wound chokes.
- L_1 —30 turns No. 14 bare wire, coil diameter $2\frac{1}{4}$ inches, turns spaced $\frac{1}{8}$ inch center-to-center.
- L_2 —16 turns $\frac{1}{2}$ -inch copper tubing, coil diameter $2\frac{3}{4}$ inches, turns spaced $\frac{1}{4}$ inch center-to-center.
- L_3 —10 turns $\frac{1}{8}$ -inch copper tubing, coil diameter $2\frac{1}{4}$ inches, turns spaced $\frac{1}{4}$ inch center-to-center.

The turn coupled to L_2 is inside L_2 at its center, and rests on the bakelite strips.

MA—0.300 d.c. milliammeter.

M—0.25 F. ammeter.

The resistor shown across the 2.5-volt filament transformer may be the usual 20-ohm unit with center-tap. If the transformer winding is center-tapped the resistor will not be needed.

between the two panels makes the coils easily accessible for changing taps from the front. The set is thirteen inches wide and eight inches deep at the bottom, and is approximately $11\frac{1}{2}$ inches high overall. The panels are 13 by $3\frac{1}{4}$ inches. Framework, panels and base are made of wood.

The three photographs show the layout quite clearly. From the front, the oscillator is at the right and amplifier at the left. The oscillator coil, which is similar in construction to that used in the R.K.-20 transmitter described in April *QST*, is mounted on miniature porcelain stand-off in-

grid choke is directly over the crystal socket; its lower end is connected to the grid leak, which is placed horizontally just above the oscillator tuning condenser projecting through the baseboard. One end of oscillator plate choke is soldered directly to the plate terminal on the tube socket, and its other end is supported on a midget porcelain stand-off. The plate blocking condenser, C_7 , is directly below this choke in the photograph. The by-pass condenser with the two cable connections is C_{11} ; R_3 is mounted alongside this condenser and R_2 above it. At the right-hand

side are the amplifier filament by-pass condensers and the plate choke, the latter being mounted on two midget stand-offs.

All power connections are made through a length of standard 8-wire cable. It is quite possible that putting the 1000-volt lead through such a cable constitutes taking unwarranted liberties, but a good many hours of operating have failed to develop any fault in the insulation. It would be inadvisable to exceed 1000 volt, however, which means that the power supply ought to have good voltage regulation so the voltage will not build up during the keying spaces.

OPERATING NOTES

The "handling" of the set as finally built is much the same as that of any other well-behaved oscillator-amplifier. The first step in adjustment is that of finding the optimum settings of the taps on L_1 . In the transmitter illustrated, these settings were: ground tap, 20 turns from plate end; grid tap, 13 turns from plate end. Set the neutralizing condenser, C_{13} at about half capacity, apply oscillator plate and filament voltages and amplifier filament voltage, close the key and determine whether it is possible to make the oscillator function. If not, other tap combinations should be tried until the oscillator starts, after which the next step is that of neutralizing the amplifier. Make sure that the shorting taps on L_2 are disconnected, then rotate C_2 until resonance is found, as indicated by a neon bulb touched to one end of L_2 . The inductance of L_2 is such that 7 mc. will be found near full capacity on a 50- μ fd. tank condenser. If the amplifier is very far out of neutralization, rotating C_2 may detune the oscillator to such an extent that it will stop oscillating, in which case it is necessary to retune C_1 (and possibly also change one or both the taps on L_1) until it is possible to tune C_2 through resonance without stopping the oscillator. With C_2 at resonance, rotate C_{13} slowly until the glow of the neon bulb goes through a minimum and increases again, making sure, meanwhile, that the oscillator does not stop. Then reset C_{13} at the point of minimum or zero glow, readjust C_2 to bring the glow back again, if possible, and retune C_1 to give maximum output. If the glow reappears when this is done, readjust C_{13} to the minimum point. It should be possible to make the bulb either go out completely or else drop to a very faint glow. When the neutralizing is brought to this point, tuning C_2 will have no effect on the oscillator.

The actual adjustment of C_{13} , the neutralizing condenser, is best carried out by using a "neutralizing stick" which can be whittled from a wooden stick ten or twelve inches long. In the transmitter illustrated, the end of the neutralizing condenser shaft has been slotted with a hacksaw so the condenser can be adjusted by such a home-made wooden screwdriver. The advantage of this

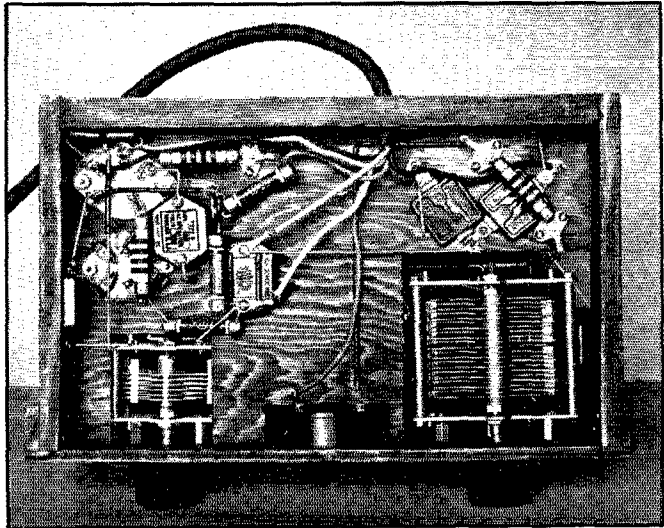

UNDERNEATH THE BASE—BY-PASSES, RESISTORS AND CHOKES

The "cut-outs" for the tuning condensers permit the rotary plates to swing downward. The amplifier tank condenser need not be a split-stator, but its use prevents hand-capacity effects at the tuning dial.

method is that body-capacity effects, always bothersome in neutralizing adjustments, can be avoided completely.

After the amplifier is neutralized, the taps on

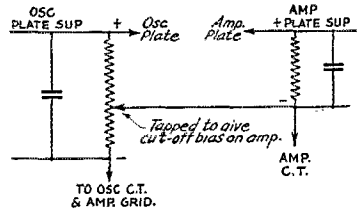

FIG. 3—METHOD OF OBTAINING AMPLIFIER BIAS FROM OSCILLATOR PLATE SUPPLY

When this method of obtaining bias is used, there must be no direct connection between the negative terminals of the two power supplies nor between the filament transformers.

L_1 can be reset to obtain maximum output from the oscillator. Probably the most convenient way of determining these settings is to insert a milliammeter in the lead between the center-tap of the amplifier filament transformer and the negative high-voltage terminal so that grid current can be

(Continued on page 78)

What the League Is Doing

League Activities, Washington Notes, Board Actions—For Your Information

Election Notice To all members of the American Radio Relay League residing in the Dominion of Canada, Atlantic Division, Dakota Division, Delta Division, Midwest Division, Southeastern Division, Revised Pacific Division (old Pacific Division minus portion now constituting Southwestern Division), Southwestern Division (the counties of Imperial, Inyo, Los Angeles, Mono, Orange, Riverside, San Bernardino, San Diego, San Luis Obispo, Santa Barbara and Ventura of the State of California, and the State of Arizona).

You are hereby notified that, in accordance with the constitution, an election is about to be held in each of the above-mentioned regions to elect both a member of the A.R.R.L. Board of Directors and an alternate thereto. In the case of the Dominion of Canada the election is to choose a Canadian General Manager and an alternate Canadian General Manager, for the 1936-1937 term. In the case of the United States divisions except the Southwestern, the election is to choose a division director and an alternate division director for the 1936-1937 term. In the case of the Southwestern Division the election is to choose a division director and his alternate for the single year 1936. Your attention is invited to Sec. 1 of Article IV of the constitution, providing for the government of A.R.R.L. by a board of directors; Sec. 2 of Article IV, defining their eligibility; By-Laws 11 to 21, providing for the nomination and election of division directors, and By-Law 12 providing for the simultaneous election of an alternate division director; By-Laws 25 to 31 providing for the nomination and election of a Canadian General Manager, and By-Law 26 providing for the simultaneous election of an alternate Canadian General Manager. Copy of the constitution and by-laws will be mailed any member upon request.

Voting will take place between November 1 and December 20, 1935, on ballots which will be mailed from the headquarters office in the first week of November. The ballots for each election will list, in one column, the names of all eligible candidates nominated for the office of director by A.R.R.L. members residing in that region; and, in another column, all those similarly named for the office of alternate. Each member will indicate his choice for each office.

Nomination is by petition. Nominating petitions are hereby solicited. Ten or more A.R.R.L. members residing in any one of the above-named

regions have the right to nominate any member of the League residing in that region as a candidate for director therefrom, or as a candidate for alternate director therefrom. No person may simultaneously be a candidate for the office of both director and alternate director. A separate petition must be filed for the nomination of each candidate, whether for director or for alternate director. The following form for nomination is suggested:

(Place and date)

Executive Committee

The American Radio Relay League

West Hartford, Conn.

Gentlemen:

We, the undersigned members of the A.R.R.L. residing in the Division [or in the Dominion of Canada], hereby nominate of, as a candidate for director [or for alternate director, or for Canadian General Manager, or for alternate Canadian General Manager, as the case may be] from this region for the 1936-1937 term [in the case of the Southwestern Division, for the year 1936].

(Signatures and addresses)

The signers must be League members in good standing. The nominee must be a League member in good standing and must be without commercial radio connections: he may not be commercially engaged in the manufacture, selling or renting of radio apparatus or literature. His complete name and address should be given. The nominees for Canadian General Manager and alternate thereto must be Canadians. All such petitions must be filed at the headquarters office of the League in West Hartford, Conn., by noon of the first day of November, 1935. There is no limit to the number of petitions that may be filed, but no member shall append his signature to more than one petition for the office of director and one petition for the office of alternate director. To be valid, each petition must have the signatures of at least ten members in good standing.

Present directors from these areas are as follows: Dominion of Canada, Mr. Alex Reid, VE2BE, St. Lambert, P. Q., Canadian General Manager; Atlantic Division, Dr. Eugene C. Woodruff, W8CMP, State College, Pa.; Dakota Division, Mr. Carl L. Jabs, W9BVH, St. Paul, Minn.; Delta Division, Mr. M. M. Hill, W5EB, Natchitoches, La.; Midwest Division, Mr. H. W. Kerr, W9DZW-W9GP, Little Sioux, Iowa; Southeastern Division, Mr. Bennett R. Adams,

Jr., W4APU, Homewood, Ala.; Pacific Division, Mr. S. G. Culver, W6AN, Berkeley, Calif.; Southwestern Division, no director at present. No alternate directors at present exist from these areas.

These elections constitute an important part of the machinery of self-government in A.R.R.L. They provide the constitutional opportunity for members to put the direction of their association in the hands of representatives of their own choice. Members are urged to take the initiative and file nominating petitions immediately.

For the Board of Directors:

K. B. WARNER,
Secretary

August 15, 1935.

Growth Figures

The number of valid amateur station licenses in existence June 30, 1935, the F.C.C. advises us, was 45,561, a decrease of 829 from the figure a year previous, 46,390. However, for the first time since our licenses went on a three-year basis, the report for the year contains a deduction for expired licenses, totalling 4,850. To see how our 1935 figure compares with 1934, we must first put it on the same basis and allow for these expirations. Except for the expirations, the figure would show an increase of 4,021, as against 4,835 increase the previous year. The 1935 figures:

| | | |
|---|--------|--------|
| Valid of record July 1, 1934..... | 46,390 | |
| Issued during fiscal year, new..... | 7,416 | 53,806 |
| Less: | | |
| Cancellations..... | 2,551 | |
| Other deletions..... | 839 | |
| Expirations (renewal yet possible) approximately..... | 4,850 | |
| Revocations..... | 5 | 8,245 |
| Net close of June 30, 1935..... | | 45,561 |

We do not know for certain how much amateur radio is growing. We will not have figures that can be compared reliably with previous years until after the full three years of the new system have elapsed, in October of 1936. We have only the above indications that the number of outstanding licenses is now about stationary. The figure that one is really interested in is the number of active amateurs, and that of course the Commission's figures do not show. During the fiscal year 1935, however, the Commission issued 7,416 new station licenses, renewed 2,725, and modified or re-issued 7,597, so that 17,738 station authorizations passed through their hands last year.

Penalties

For successive offenses against the same F.C.C. rule, such as operating out of a band, increasingly severe penalties are provided. Although we have wanted enforcement, one unfortunate aspect of it is its discouragement to experimental work. Amateurs are supposed to be experimenters, and in the course of experi-

ments must expect occasionally to get a bad adjustment for a brief period. This restriction is perhaps especially important, and the trouble especially liable to happen, in the course of experimental work dealing with band-switching, which our Board wishes to encourage. The present system would cause the penalizing of such an experimenter upon his third offense, even though the offenses were years apart. Our regulations of course are at cross purposes in attempting both to facilitate experimentation and to prevent the violation of rules. Discussing with the Commission the proposal of W6AM, published in our Correspondence columns, the League has effected a compromise arrangement which will hereafter provide that cases where a year elapses between the second and third offenses against the same regulations will be reviewed and action taken according to the merits of the case, continuing to penalize the wanton offenders and applying leniency where it seems merited.

Washington Notes

Captain S. C. Hooper, for the past seven years the Director of Naval Communications, was succeeded in that post on August 9th by Captain Gilbert J. Rowcliffe. The latter has just left the command of the Battle Force Squadron at San Diego. Captain Hooper has become a special technical assistant of the Director of Naval Operations, coördinating the technical and scientific work of the Navy.

The F.C.C. has reprinted the revised amateur regulations, correct to June 1st, in the form of a small pamphlet, available free to amateurs from any office of the Commission. The complete regulations also appear in the A.R.R.L. *Handbook and License Manual*.

The F.C.C. has not yet come to a decision about the requested revoking of the "music testing" rule.

Cairo Notes

The Egyptian government has set February 1, 1938, as the date for the opening of the Cairo conference. The preparation of United States proposals therefor will not begin until next year. . . . The member societies of the I.A.R.U. are now engaged in determining their Cairo policy. . . . It is expected that most of the member-societies will engage in surveys of the occupancy and activity in frequency bands adjacent to ours, to make possible a world-wide analysis as part of the amateur preparation.

Financial Statement

The League lost \$3,877.97 from its normal operations during the second quarter of this year, an amount which is about normal for that season. There was a net operating gain for the first half of the year of \$1,574.13. Our business affairs continue definitely good, our advertising particularly showing a nice improvement over last year. The re-

cently-adopted idea of sectionalized advertising is both paying its way nicely and making possible the improved Communications Department news. *QST* circulation continues a steady and healthy growth. At the instructions of the Board of Directors, the operating statement for the second quarter of the year is here published for your information.

STATEMENT OF REVENUES AND EXPENSES,
EXCLUSIVE OF EXPENDITURES CHARGED
TO APPROPRIATIONS, FOR THE THREE
MONTHS ENDED JUNE 30, 1935

| REVENUES | |
|--|-------------|
| Membership dues..... | \$ 9,300.55 |
| Advertising sales, <i>QST</i> | 16,724.37 |
| Newsdealer sales, <i>QST</i> | 11,278.68 |
| Handbook sales..... | 6,557.37 |
| Booklet and calculator sales..... | 3,032.29 |
| Membership supplies sales..... | 2,089.51 |
| Interest earned..... | 321.36 |
| Cash discounts received..... | 207.82 |
| Bad debts recovered..... | 13.00 |
| | \$49,524.95 |
| <i>Deduct:</i> | |
| Returns and allowances..... | \$ 4,292.88 |
| Cash discounts allowed..... | 308.32 |
| Exchange and collection charges..... | 6.70 |
| Net adjustment covering portion of miscellaneous sales taken into revenues in prior periods, included in revenues for this quarter under proper classifications..... | 1,312.82 |
| | \$ 5,920.72 |
| Less reduction of provision for newsdealer returns of <i>QST</i> | 593.10 |
| | 5,327.62 |
| Net Revenues..... | \$44,197.33 |
| EXPENSES | |
| Publication expenses, <i>QST</i> | \$14,661.34 |
| Publication expenses, Handbook..... | 2,536.05 |
| Publication expenses, Booklets and calculators..... | 1,209.35 |
| Membership supplies expenses..... | 1,196.04 |
| Salaries..... | 19,706.90 |
| <i>QST</i> forwarding expenses..... | 708.37 |
| Telephone and telegraph..... | 471.51 |
| Postage..... | 1,233.52 |
| Rent, light and heat..... | 816.93 |
| Traveling expenses..... | 1,799.91 |
| Depreciation of furniture and equipment..... | 231.50 |
| Office supplies and general expenses..... | 2,223.83 |
| Communications Dept. field expenses..... | 149.62 |
| Headquarters station expenses..... | 81.87 |
| Bad debts written off..... | 1,048.56 |
| | 48,075.30 |
| Total Expenses..... | 48,075.30 |
| Net Loss before Expenditures against Appropriations..... | \$ 3,877.97 |

C.C.I.R. Work is beginning for the fourth meeting of the International Technical Consulting Committee on Radiocommunications, to be held in Rumania early in 1937. The nations of the world are commencing their technical studies. I.A.R.U. headquarters is contributing studies on four of the questions, and work on

this activity has now commenced at our office. . . . The A.R.R.L. Board of Directors has offered to send representatives in the name of the I.A.R.U. to the Bucharest meeting if the other member-societies of the Union will contribute to the expense in proportion to their respective memberships.

Foreign Notes

Mexico has again changed her amateur regulations, possibly to some betterment of the interference conditions but still retaining the 7-mc. band in the 'phone assignments, which has been the chief cause of complaint. Present assignments:

| <i>Radiotelegraphy</i> | <i>Radiotelephony</i> |
|------------------------|-----------------------|
| 1,715- 2,000 kc. | 1,750- 2,000 kc. |
| 3,500- 3,800 | 3,750- 4,000 |
| 7,000- 7,300 | 7,000- 7,300 |
| 14,000-14,400 | 14,100-14,300 |
| 28,000-30,000 | 28,000-30,000 |
| 56,000-60,000 | 56,000-60,000 |

Venezuela has ratified the Madrid convention and its radio regulations, and thus the radio provisions of that treaty are in full effect between the United States and Venezuela.

More important to us, China has now done the same thing. Because China has refused agreement to a "special arrangement," this means that we are now prohibited from exchanging third-party messages with the XU stations. Up to now we have been free to handle such traffic without a special arrangement, since China was not party to the treaty. However, in point of fact it seems that the Chinese government has pretty effectively prohibited the handling of traffic from the other end since early this year. See page 66 of *QST* for March, 1935. In fact, it seems that the Chinese government is making a determined effort to abolish all amateur radio in that country. The League is endeavoring to assist those in China who depend upon the services of amateur radio, particularly in places where the telecommunications service is inadequate.

Madrid Note

A critic "accuses" the League representatives of "having made a deal with the American delegation [to Madrid] that the amateurs would ask for no more frequencies, and that, in return, the delegation would give the amateurs full support," and says that this has never been denied. He is correct; that is precisely the understanding which was arrived at, at the instructions of the A.R.R.L. Board of Directors, at the time the United States prepared its position for Madrid, as a fundamental part of the Board's policy with respect to that conference. And it was the unyielding persistence of the United States delegation, pursuant to that understanding, that preserved our frequencies against the many attacks that were there made upon them.

Reducing QRM on 56 Mc.

Notes on Methods and Equipment Used in the Boston Area

By C. F. Hadlock,* WICTW

ABOUT seven months ago, after a period of inactivity, it was decided to give the five-meter band another whirl. Consequently, the old super-regenerative receiver was pulled down off the shelf and put into service again. It was immediately noticed that the activity on this band in and around Boston had grown tremendously. Everyone worked complained of QRM and it was nearly impossible to hold a QSO for more than five minutes without being "put out of the picture" by an interfering station. One ham was heard to remark, "QRM on eighty meters! You ought to see what it is like on five."

It seemed logical to try cutting down interference by using a more selective receiver. A receiver which was broad enough to allow not more than twelve or fourteen stations to come through without interference on a band 4000 kc. wide should certainly not be considered satisfactory. Hence, the super-regenerative receiver was put back on the shelf and a National Type HFC five-meter converter was trimmed for action. This converter was designed over two years ago but was considered too selective for the transmitters then in use. Further, the interference problem was not bad enough, then, to make its use necessary.

If a signal has very bad frequency-modulation, that signal will cover a wide frequency range and the receiver must be broad enough to admit this whole range of frequencies. If the receiver is sharp, only a narrow slice of this frequency range will be admitted to the receiver and the voice will be distorted and fuzzy, if not wholly unintelligible. This accounts for the fact that some superheterodynes use i.f. amplifiers that are deliberately made very broad, thereby partly nullifying the outstanding advantage of the superheterodyne type of receiver. One super which has become very common around Boston even uses a resistance-coupled i.f. amplifier!

The HFC converter uses three tubes, a Type 24 electron-coupled h.f. oscillator, a regenerative electron-coupled 1st detector, using a Type 24 tube with grid leak bias and a tuned trap in the grid circuit to give i.f. amplification in the first detector, and a low impedance i.f. stage using a Type 27 or 56 tube to enable the converter to be coupled into the antenna stage of any type of broadcast receiver. An old broadcast tuner was renovated from the back room. It uses three stages of tuned r.f. and has much more gain than

is necessary. The coils in this tuner were cut down slightly so that 1550 kc. (the i.f. frequency for which the converter was designed) could be easily reached. This tuner is probably three or four times as broad as a good modern broadcast receiver. Then the converter was connected to the broadcast receiver and put into action.

An untuned single wire was used for the antenna and gave about the same pick-up as was obtained with the same antenna used on the super-regenerative receiver. Next, a tuned "Pickard" type antenna was installed with feeders about sixty feet long.¹ The two feeders were brought down into the first detector compartment and coupled to the detector coil with a two-turn coil wrapped solidly around the top of the coil form.

Unexpected trouble showed up immediately. Since the grid circuit of the first detector contains a trap tuned to 1550 kc., the grid picked up

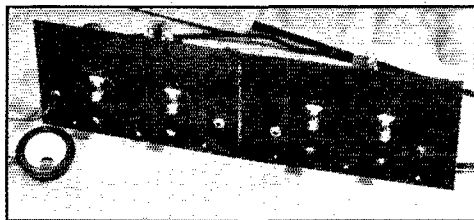

THE TWO-UNIT TWO-TUBE M.O.P.A. 56-MC. TRANSMITTER

The four dials belong to the four tuned circuits of the transmitter. Jacks are provided to allow checking of the oscillator plate current and the grid and plate current of the amplifier.

police and fire department stations operating in the vicinity of 1550 kc. strongly enough to block the receiver up solid when they were operating. The antenna acted as an untuned collector for these frequencies and passed them on to the grid of the first detector by means of the capacity coupling from the feeders and pick-up coil in the detector compartment. This was completely cured by attaching a quarter-wave feeder (at 58 mc.) to the antenna feeders and grounding the other end of this feeder. This grounded the system as far as pick-up on 1550 kc. was concerned, but did not affect the operation of the system at five meters. The same effect can also be produced by grounding the center of the pick-up coil.

¹ The antenna was described in *QST*, August, 1933, "A Toolbox Transceiver."

* 20 Hillside Terrace, Malden, Mass.

We were pleasantly surprised to notice that, in addition to suppressing the undesired long-wave signals, the antenna picked up far less noise and

have perfectly clear speech with *no* distortion due to frequency modulation. About seventy per cent of the stations received have frequency modulation ranging from slightly fuzzy to barely readable. The other twenty-five per cent are not readable and, since there are plenty of stations which can be worked using this receiver, this twenty-five per cent are not QSO'd.

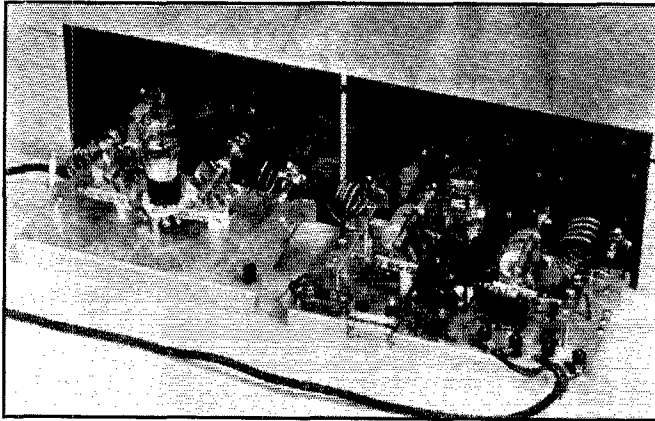

A REAR VIEW OF THE SIMPLE OSCILLATOR-AMPLIFIER TRANSMITTER

The neutralizing condensers are mounted on the same bakelite strip which supports the amplifier tube. Since the photograph was taken, plug-in coils have been fitted to the oscillator also.

ignition QRM. Because of its high selectivity, this receiver layout immediately revealed the faults of the various transmitters on the air. Some 150 stations have been received during the past seven months and the following facts brought out:

1. The selectivity of this receiver is such that 200 stable R8 signals could be placed side by side within the limits of the five-meter band with absolutely no interference between stations. This allows twenty kilocycles per station, which certainly is not unreasonable. The QRM problem is solved as far as the receiver is concerned and it is strictly up to the transmitters. The band covers about 90 divisions on the dial and stable signals, such as those from W1HUV, W1HY or W1INC, can be tuned in and out completely in about one-half of a division. However, the average signal covers about three or four divisions and one local was once picked up when he splashed over thirty-five divisions!

2. About five per cent of the stations received

considered as perfect. These are W1FQV at Harvard University in Cambridge, Mass., and W1AGR of Norwood, Mass. However, W1FQV's signal grew imperfect when he modulated it heavily. Two types of results seem to be obtained by these

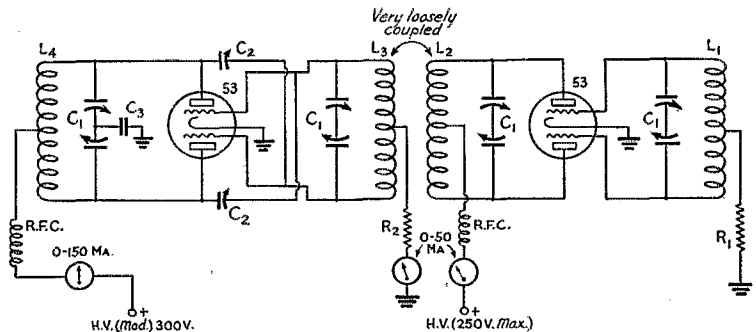

FIG. 1—CIRCUIT OF THE SIMPLE OSCILLATOR-AMPLIFIER TRANSMITTER

- C₁—National STD 50 split-stator condenser.
- C₂—National STD type with 1 rotor and 1 stator double-spaced.
- C₃—.01- μ fd. fixed condenser.
- For five meters:
- L₁—3 turns 1" diameter.
- L₂—1½ turns 1½" diameter.
- L₃—2½ turns 1½" diameter.
- L₄—4 turns 1½" diameter.
- L₂ and L₃ are inductively coupled at least three inches apart.

- For ten meters:
- L₁—6 turns 1½" diameter.
- L₂—4 turns 1½" diameter.
- L₃—6 turns 1½" diameter.
- L₄—6 turns 1½" diameter.
- ½-inch copper tubing used for all coils.
- RFC—National Type 100 chokes.
- R₁—2000-ohm, 1-watt resistor.
- R₂—1500-ohm, 1-watt resistor.

The antenna may be coupled with a conventional split antenna coil or by tapping the feeders on L₄.

"short-line controlled" transmitters. Some fellows obtain excellent stability but have very bad drift. Others have very little drift but considerable frequency modulation. Occasionally, a

"flutter" is observed on some of these stations due to the antenna feeders swinging in the wind or vibration of the parts of the oscillator. Sometimes, a sort of super-regeneration is observed, usually due to tight coupling to the antenna. This shows up as a number of separate, distinct, carriers covering three or four hundred kilocycles. Most of the operators insist on using the grids connected to the open ends of the grid line instead of taking them down toward the shorted end.² It is to be remembered that these characteristics would not be apparent when using the average super-regenerative receiver, due to the lack of selectivity of that type of receiver. Most of the fellows do not know what results are being obtained with their transmitters and a perfect or near-perfect signal is usually a matter of luck. About the only means of obtaining a reliable check is to tune the transmitter with a simple heterodyne monitor or hook up with a station using a sharp receiver. This type of receiver is not, of course, the only one selective enough to show up imperfections in transmitters. The so-called "Minute Man" super-regenerative rig shown in Fig. 2 will readily pull a badly frequency modulated signal to pieces.

Only one station has been heard who was using "Tin Hats."³ This was WIGFW in Belmont, Mass. His results, while not perfect, were quite satisfactory. The drift and frequency modulation were low, although he was often bothered by a "frequency flutter" due, probably, to vibration of the "hats."

After using this receiver for some time, it was decided to attempt to build a simple transmitter that would consistently give results good enough for use with this type of receiver. The question arose as to what line of attack should be followed. The receiver just described brought out five important qualities to be considered in building a stable transmitter

for five-meter work. They are:

- A. Freedom from frequency modulation.
- B. Freedom from frequency drift.
- C. High percentage of modulation.
- D. High output and efficiency.
- E. Freedom from effect on frequency of the antenna.

Now, if some form of stabilized modulated oscillator is to be built, a compromise becomes

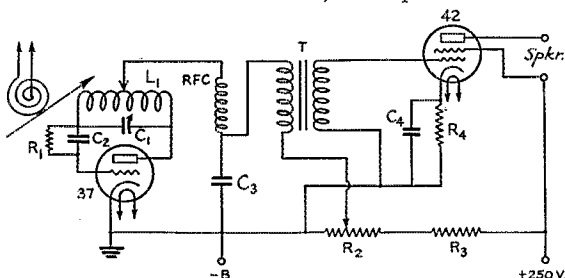

FIG. 2—A SIMPLE SUPER-REGENERATIVE RECEIVER MADE POPULAR IN BOSTON BY ITS SUPERIOR PERFORMANCE

Its selectivity is much higher than the usual super-regenerator.

C₁—National SEU with two-thirds of plate removed—5 μ fd. max.

C₂—50- μ fd. fixed midget condenser.

C₃—Between .002 and .006 μ fd.; experiment usually necessary to determine best value.

C₄—10- μ fd. electrolytic low-voltage condenser.

L₁—8 self-supporting turns of No. 18 wire, 1/2-inch inside diameter. Turns spaced diameter of the wire. Best position for tap is usually near center of coil.

RFC—40 to 50 turns of No. 26 d.c.c. wire on 1/4-inch rod, the rod being removed.

R₁—As high as possible—20 megohms has been found best in some instances.

R₂—50,000-ohm potentiometer.

R₃—50,000-ohm 1-watt fixed resistor.

R₄—2000-ohm, 1-watt. This value is higher than normal but has been found desirable.

T—Good audio transformer with ratio of 1:3 or less.

All grounds must be brought to a single point on the chassis. The detector tube is mounted horizontally with the plate prong soldered at the junction of the condenser and coil, and just enough space between the grid prong and the other end of the coil to accommodate the midget grid condenser. The receiver should be considered unsatisfactory unless the detector operates with 25 volts or less on its plate. The antenna coil is a 5-turn spiral with adjustable coupling to L₁.

This circuit and data supplied by Dwight Hill, W1HUV.

necessary. If conditions A and B are met, there must usually be a sacrifice of D and C and vice versa. Stability and low drift mean low modulation and low input. Condition E must be met by making everything as solid as possible.

One approach is to separate the functions of conditions A and B from those of conditions C and

² See "Stabilizing the Ultra-High Frequency Transmitter," QST February 1935.

³ See May QST 1934 "High-Q Tank Circuits for Ultra-High Frequencies."



THE OSCILLATOR-AMPLIFIER 56-MC. TRANSMITTER AT W1HUV

The oscillator and first amplifier of this rig follow the circuit of Fig. 1. The second 53 tube drives a pair of 841's in push-pull. The receiver used at this station is that shown in Fig. 2.

D. The only way to do this is by the use of separate circuits. This means the m.o.p.a. type of transmitter. The master oscillator (or means of obtaining excitation) can be made as stable as possible by the use of "Hi-C" and loose coupling to the modulated amplifier. Of course, a buffer stage between the master and the modulated amplifier will give still better stability. Crystal control is, of course, ideal. Low frequency drift can be obtained by the use of "Hi-C" tank circuits and low input to the master oscillator. This stage must produce only enough output to excite the following stage. The modulated amplifier can meet conditions C and D very nicely as it should be capable of 100% modulation and will take a relatively high input. The efficiency is also excellent as it is not necessary—as in the case of the oscillator—to subtract part of the power output from the plate circuit to be fed back to the grid circuit for excitation. Condition E is met automatically as the antenna is removed from the frequency generating part of the transmitter and therefore cannot affect the frequency.

However, to be popular with the five-meter gang, this m.o.p.a. transmitter must use a minimum of parts. About two years ago crystal control was installed at W1BZR and W1CTW but the obvious disadvantage was the comparatively large number of parts necessary. However, out of this work with crystal control, came several things of value. An exciter unit was developed using two Type 53 tubes and giving reasonably good output on five meters starting with a forty-meter crystal. This exciter is described in the *Handbook* and *QST*.⁴ When followed by another 53 as a neutralized buffer, ample excitation is obtained on 56 megacycles to excite a pair of any of the popular low-power tubes to about 60 or 70 watts input. Thus, crystal control on five meters becomes practical.

Also, W1BZR found these two facts to be quite important on both five and ten meters: First, single-ended neutralized amplifiers should be avoided. A single-ended amplifier is apt to oscillate at these frequencies, even though perfectly neutralized. This is because the filament (or cathode) leads, being common to both the grid and plate circuits of the amplifier, may have high enough impedance to couple these two circuits and produce sustained oscillation. Often this effect will not show up until excitation has been applied. The cure, of course, is to use push-pull.

⁴ *QST* October, 1934. Twelfth edition *Handbook*, p. 110.

Secondly, capacity coupling is practical *provided* you move the coupling condensers about halfway down the coil toward the center.

With these points in mind, a simple m.o.p.a. was built up using a pair of 45's as master oscillator, capacity-coupled to a pair of 46's as a modulated amplifier. A check was obtained from W1KH, who said it was not appreciably better than a modulated oscillator. Later, it was remembered that W1HSV of Cambridge, Mass., had been heard with an excellent signal while using a simple two-stage m.o.p.a. of the type suggested by D. A. Griffin, W2AOE.⁵ So, it was decided to use inductive coupling between the oscillator and amplifier, as described in that article. Also, desiring to cut the number of tubes used to only two, while still using push-pull circuits, Type 53 tubes were used with inductive coupling, as described by Griffin. This resulted in a very satisfactory signal. W1KH reported that the quality was perfect, that the drift was negligible and thought I was using crystal control! The input to the final amplifier was 30 watts and it was modulated 100%. The circuit diagram is shown in Fig. 1. The 53 tube, when used as a t.p.t.g. oscillator, has an "upside down" dip in the plate current when the oscillator is tuned. It is *very* essential to use a *tuned* grid circuit. This grid condenser makes a very good excitation control and should be adjusted to give the required grid current in the amplifier with the lowest possible oscillator plate current. The plate coil of the oscillator (L_2) should be just large enough so that the tuning condenser

(25 μ fd. net capacity) is set at almost maximum capacity when the transmitter is tuned to 56 megacycles. It is quite advantageous to use a grid milliammeter in the amplifier and the grid current should be between 25 and 30 milliamperes under normal operating conditions. The general set-up of this transmitter is shown in the photographs. The coupling between the two units is varied by sliding them toward each other. The frequency modulation of this transmitter at 100% modulation is not over 15 kc. It neutralized very nicely, although the setting of the neutralizing condensers is quite critical. An effective way to neutralize it is to watch the grid milliammeter. The meter should show no flicker when the amplifier plate condenser is tuned through resonance.

(Continued on page 82)

⁵ "Graduating to Oscillator-Amplifier Transmitters on 56 Mc.," *QST* May 1933.

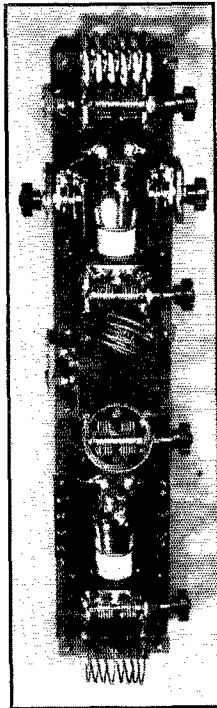

ILLUSTRATING A SPACE-
SAVING LAY-
OUT FOR THE
TRANSMITTER US-
ING RK 34 TUBES

The circuit is the same as that of Fig. 1. The transmitter is screwed to the shack wall in a position handy to the feeder.

W2MO, Portable, Sets the Pace on 56 Mc.

By John Diecks, W2HPV*

As most of us anticipated, the summer of 1935 was certainly a hot one on the ultra-high frequencies. Activity throughout the country has grown by leaps and bounds and, with our improved equipment, the general performance obtained has hit new highs. In the Atlantic States in particular, the 56-mc. band is swarming with signals every night and backyard-to-backyard contacts over distances up to 200 miles have become relatively common. This type of "air-wave" DX is not, of course, consistent since the necessary bending of the waves would seem to occur only when a strong temperature inversion prevails in the lower atmosphere. This summer, though, has given us scores of nights when conditions were right and any 56-mc. ham in these parts will tell you that the season has been packed with thrills.

W2HPV's story of an evening spent with W2MO's portable rig is presented because it paints an accurate picture of the extraordinary work being done on 56 mc. W2MO's set-up is exceptional, but countless other fixed, portable and mobile stations are doing somewhat similar work right along.—EDITOR

ON THE evening of August 10th, W2MO of Livingston, N. J., operating portable with 56-mc. equipment in his automobile at Garret Mountain, a mere hill 550 feet above sea level, in the city of Paterson, N. J., was successful in working not only a first district station but literally the first district. At about 8:30 p.m. daylight time, he swung his automobile in such a direction as to have the eight-element antenna on the car concentrate toward the Boston area, and from that time until 1:00 a.m., one first district station after another was worked.

During this period 32 different first district stations were worked and identified, with five or six more worked but not identified on account of local QRM. The location of the portable equipment is, of course, in the heart of the New York area QRM and it was through this that the first district stations had to be contacted. The number of distant contacts on five meters in such a short period of time is probably without precedent, and the total of the miles worked during the contacts, 5661, is probably also a record.

The W2MO gear has been operated portable for the past four summers, during which time a total of 535 different stations have been worked, with the total number of contacts well above 4000. The equipment is carried in a touring sedan, and includes both power supply and directive antenna. The transmitter employs a pair of 801's with 50 to 80 watts input, power packs using 82's supply the plate power. Primary power comes from a portable gas engine generator providing 300 watts, 60 cycle a.c. The antenna may be varied from a single half-wave element

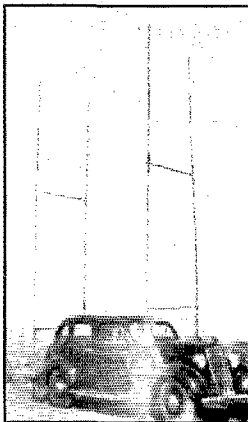

A HIGH-PERFORMANCE SET-UP FOR PORTABLE 56-MC. WORK

W2MO's auto, parked in some favorable spot, and fitted out with an eight-element directive array. Four half-wave antennas and four reflectors are supported on four 20-foot bamboo poles. The outfit does things.

to an array of 8 half-wave elements, the array giving an enormous gain in signal strength both in transmission and reception. The complete beam mounts on four 20-foot bamboo poles, two attached to the rear bumper, and two to the two spare wheels in the front fender wells. The car must of course be placed broadside to the desired direction of transmission, as the distance between the opposite sides of the car is just about one-quarter wavelength. Each pole carries two elements, one phased above the other. A break-in relay allows the same antenna to be transferred from receiver to transmitter. A standard three-tube super-regenerative rig is used for all reception.

The first district stations worked were in Connecticut, Massachusetts and Rhode Island and included DEK, IYS, GDJ, EZL, BSI, HHU, DPW, AZX, DBE, HBD, ZE, AOZ, CDR, ZJ, DQ, QP, DDM, DEI, HVP, HMA, AGR, GMT, HWC, IWG, NF, FJN, CKV, HOB, HSP, HXY, AIY, HDQ. Additional stations worked but not completely identified may be added as QSL's are received. On this particular night W2MO was accompanied by the present writer, and the two ops. were kept mighty busy with the mike, log, and card index of stations worked.

Strays

Death Rays

Speculation is rife concerning Marconi's rumored method of disabling airplane motors by a mysterious ray. According to Prof. Dr. Turnonoff, well-known QST contributor of articles on stuff, the secret lies in use of his exclusive discovery, negative wavelengths.

* 233 E. Northfield Ave., Livingston, N. J.

H A M D O M



R. P. IRVINE, W8CIO-WLHC, gets his biggest kick out of life when left alone with a lot of coil forms, plenty of wire, a good active block of quartz, and a good frequency meter. We can think of one bigger kick he *almost* got, for we have seen pictures of his high-tension crew at work on a tall pole bearing a *live* 23,000-volt wire! At present, W8CIO is in the radio interference department of the Cleveland Power and Light Co. His radio career began in 1907, and he was first licensed in 1913-14. He joined the A.A.R.S. in 1931, and in 1933 was made State Net Control Station. Right now he's S.C.M. of Ohio—and getting a lot of fun out of it. Most of the equipment in the shack consists of frequency-measuring apparatus, although there is a transmitter with a pair of '03-A's final, powered by a 1000-volt storage battery. With two daughters, the oldest now married to a ham, W8DVL, the youngest studying hard for her ticket, W8CIO demands, "What more can I do?"



RAY CUMMIN'S first contact with amateur radio was in 1914 when, while making his getaway from a successful raid on the neighbor's grapevine, he became entangled in the neighbor's counterpoise system, with resultant bruises, welts, and lost dignity. As punishment, he was taken in to see the rig. First, parental objections, then school work, and finally marriage conspired to prevent the culmination of years of experimenting by licensing, until finally in 1931, together with the banjo player in his band, he took the exam. The ticket that followed said W7ABZ (the banjoist is W7APG). The S.C.M. ship of Oregon came in 1932, along with editorship of "Parasitics." W7ABZ has since been chairman of the 1933 Northwestern Division Convention, sometime president of the R.C.A.R.C., organizer of the Portland Sevens, and participant in important emergency work. Pet dislikes: artichokes, and the eternal quibbling of some hams against the League.



WILFRED SKALFE, VE4EL, was a keen amateur motorcyclist in the days of Jake De Rosier. Now he's an equally keen radio amateur. In between those dates he: 1. Followed the doings of Wilbur and Orville Wright with great interest in 1904. 2. Assisted at a radio demonstration that same year, where an antenna was cited as likely to improve the signals (but never tried). 3. Made liquid air for Frederick Soddy of the Roëntgen Society in 1905. 4. Radio interest revived in 1921. Listened to PWX that year with one tube and vernier tuning coil (no tuning condenser). 5. Received operating license in 1928 and helped organize present Regina Club in that year. 6. Contacted Connecticut and California on 28 mc. in 1931. 7. Demonstrated a p.p. rig on 3.8 meters at the Club that year. 8. Elected S.C.M. of the Saskatchewan section in 1932.



DAVID TALLEY, W2PF-WLNA, is another ham whose Army career rivals his ham career. (If we seem to be concentrating on Army-Amateurs this month, forgive us.) In 1925 he was appointed to represent the 2nd Corps Area in the newly-formed A.A.R.S. In 1926 he was commissioned 1st Lieutenant, and his Army career began. In 1930 he was promoted to a Captaincy. He is now Radio Aide to the Signal Officer of the 2nd Corps Area. His ham career features a continuous appointment as O.R.S. since the inauguration of that position, and O.O., O.B.S. and R.M. appointments at various intervals. He is treasurer of the Hudson Division Fund, and has been treasurer of the various divisional Conventions. At present he is one of the assistant directors for the Hudson Division, covering the New York and Long Island sections—what more can we add?



Background for Single-Side-Band 'Phone

A Simplified Explanation of Modulation and Detection Principles From a Non-Mathematical Angle

By James J. Lamb*

By action of the 1933 A.R.R.L. Board Meeting, the technical staff of QST was instructed to investigate the feasibility of single-side-band carrierless 'phone transmission on amateur frequencies. According to instructions, this investigation was made, in both theoretical and practical aspects, by QST's Technical Editor, J. J. Lamb, and a report to the Board was rendered in 1934. The present article, and material to appear subsequently, is based on this investigation and is published by permission of the Board for whom the report was prepared. It is of particular interest at the present time, not only because of the original and simplified method of approach, but also because of the new interest in single-side-band 'phone resulting from recent commercial developments which are strikingly similar in nature, as future QST articles will reveal.—EDITOR.

IN ORDER to get at the practical problems involved in both double- and single-side-band telephony, it is necessary first to acquire a more generalized physical concept of the mechanics of modulation and detection, and a more complete picture of the constitution of a modulated wave, than we are accustomed to employ in dealing with 'phone communication. (The term "ordinary" is here used to designate normal carrier and double-side-band transmission as it is generally used.) This concept has heterodyne or beating action as its basis, and is illustrated by the familiar instance of beat-note detector operation.

Let us take, for example, the simple autodyne type receiver, in which the self-oscillating detector is used to combine an incoming c.w. signal voltage with the locally generated r.f. voltage so as to produce the audio-frequency beat-note having a frequency equal to the difference between the two original frequencies. The circuit is arranged so that the incoming signal is impressed on the detector's grid, along with the self-generated oscillator voltage. The plate circuit has impedance for the audio-frequency beat-note in the form of a pair of telephone receivers or an audio transformer and has small impedance for the two original radio-frequencies, being by-passed for the latter.

Now we ordinarily think of the audio-frequency beat-note as the sole product of this heterodyne detector action, because it is the one we make use of. However, there is actually produced, in addition to the audio beat-note having a frequency equal to the *difference* between the two original frequencies, another component of radio frequency equal to the *sum* of the two original frequencies. The latter is also filtered out in the detector plate circuit, along with the original radio-frequency components and their harmonics.

The important point is that this process of de-

tection is essentially identical with the process of modulation. The locally generated r.f. component may be considered the *carrier*, in this case modulated by the incoming radio wave serving as the *signal*. The difference-frequency beat-note represents the *lower side-band*; and the sum-frequency component, which is by-passed, the *upper side-band*. Since the difference-frequency beat-note, or lower side-band, is the only component selected and utilized, *we have here an actual instance of single-side-band operation*. Therefore, it is evident that the single-side-band idea is not really new in amateur work. We make use of it in every application of heterodyne reception, including frequency conversion in the first detector of a superhet. Moreover, it is not improper to view our c.w. telegraph transmission as a system of single-side-band transmission, in which the dot-and-dash emitted wave is an intelligence-carrying single-side-band which is combined with a locally generated carrier at the receiver to give the familiar coded beat-note.

This concept, introducing interchangeable use of the terms "detection" and "modulation" in the same operation, might seem confusing at first glance. On the contrary, however, it is clarifying rather than confusing because modulation and detection are physically identical. The only real distinction is that modulation implies the application of intelligence to the wave for transmission; while detection implies the continuation of the same process for separation of the intelligence from the wave in the receiver.

Generalizing further, there are three features basic to either a modulating or detecting circuit. The first is that the circuit must contain a unilateral or rectifying element such as a vacuum tube. The second is that there must be provision for introducing into the unilateral (rectifying) element the alternating voltages of different frequency which are to be combined. The third is that there must be an output element to select the

* Technical Editor.

desired resultant of this combination. (Fig. 1.)

In the case of the autodyne detector, with the vacuum tube suitably biased to give good rectifying action and to oscillate at the same time, the tuned input circuit provides impedance for both the incoming wave and locally generated oscillation, both of which are applied to the grid circuit. Telephone receiver or audio transformer in plate circuit provides the output impedance to select the desired product of the combination, in this case the audio-frequency beat-note.

From this illustration it is a short step to voice modulation of a radio-frequency carrier in the 'phone transmitter. The essential difference is in the frequencies of the original voltages that are combined and in the product that is selected in the output circuit. Take, for instance, a radio-frequency amplifier with grid or plate modulation. The carrier-frequency excitation is applied to a control grid circuit, which contains a resonant tank of high impedance for the excitation frequency. The modulating signal in this case is applied to a grid or in the plate circuit, across a modulation choke (or through a coupling transformer) having high impedance for audio (voice) frequencies. This audio impedance is by-passed to have low impedance for radio frequencies. Output circuit must have high impedance for the desired resultant of the combination of the carrier and modulating (signal) frequencies.

As in the case of the autodyne detector, the possible products of the modulation process will include a component of radio frequency equal to the *sum* of the two original frequencies (the upper side-band), and another of radio frequency equal to the *difference* between them (the lower side-band), in addition to the two original frequencies. Now we know that the desired product must be at least one radio-frequency component carrying the intelligence that we want to transmit; that is, at least one side-band produced by combination of the carrier and the modulating signal. But here the upper and lower side-band frequencies are but slightly different from the carrier frequency, since the carrier is of high radio-frequency and the modulating signal of relatively low audio frequency. Hence, an output circuit such as a tuned tank that has high impedance for one of the side-band products will also have practically the same impedance for the other side-band and for the carrier. Therefore, in ordinary 'phone transmission, with the output tank tuned to the carrier frequency, *the carrier and both side-band components are selected and transmitted*. Since the output tank has negligible impedance for audio frequencies, the original modulating signal does not appear in the output circuit.

In reception of the complete modulated wave comprising the carrier and double side-bands, the carrier functions only to beat with the side-band components in the detector to reproduce the original modulating signal, continuing to its conclusion the operation of modulation, previously described. As contrasted to the instance of autodyne

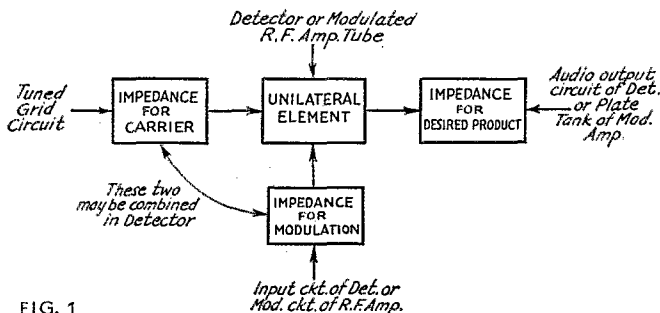

FIG. 1

c.w. detection, where a locally-generated carrier was used, here the carrier is automatically supplied with the side-bands in the received wave. This is an important aspect in double-side-band voice communication because it is especially required that the relationship between the carrier and side-band components be precisely maintained not only as to frequency but also as to phase. With the carrier suppressed and both side-bands transmitted, it is practically impossible to supply a locally generated replacement carrier in the precise relationship needed for undistorted reception. For this reason the proposed system of double-side-band transmission with the carrier suppressed (and re-supplied in reception) is hardly practicable. The frequency band required would be as great as for the ordinary double-side-band type.

New Code Champion!

FLASH!!! T. R. McElroy is the new World's Code Speed Champion! In one of the most brilliantly contested tournaments ever held this operator led all participants in a world's championship radio code contest held at the Brockton (Mass.) Fair on September 14th. J. W. Chaplin, who established the record of 57.3 words per minute at the World's Fair in Chicago, put up an admirable fight to hold the title, being bettered by only *one error*. McElroy copied 69 words per minute with two errors only, while Chaplin copied the same speed making three errors. The other three of the five contestants were J. B. Donnelly and V. S. Kearney of New York, and J. S. Carter of Boston. *All five contestants broke the previous 57.3 w.p.m. record!!!* Those who witnessed the tournament could but marvel at the ease with which all participants copied speeds which sound like a mere "jumble of dots and dashes" to the average operator. We even wonder if it were not more of a thrill for the onlooker than for the contestant! Hats off to the new Champion—Ted R. McElroy!

A Multi-Purpose Test Circuit

By Jim Kirk, W6DEG*

EVERY experimenter has wanted, at one time or another, a test circuit built around a tube for various measuring purposes. Besides, hams still like to listen on the long waves and use the honey-comb relics around the shack. Here is an instrument for both uses. It is compact, devoid of haywire, and can be changed readily from circuit to circuit without any soldering or loose contacts. Every unit is available separately.

The heart of the instrument is a calibrated variable condenser. I used a General Radio but removed the dial and used the variable ratio dial made by National instead. The latter dial has a convenient place for writing in the capacity calibration from the General Radio dial.

Any sheet metal worker will make up a metal box to your specifications. All the necessary holes can then be drilled and the black crystalline finish baked on. It is well to have the box put together with sheet metal screws and use no

hibitive, but if you can find a company doing a great deal of enameling and have them include it with their other work it will cost very little.

It will be noted that colors are marked on all

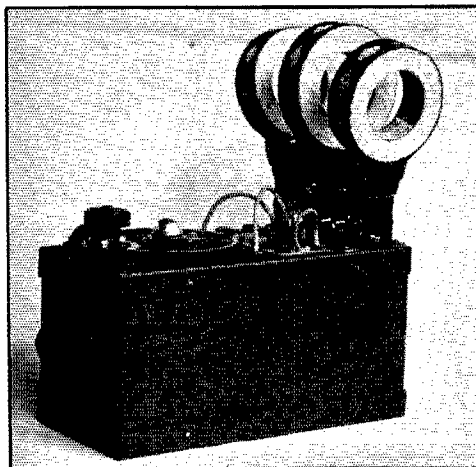

THIS COMPACT UNIT WILL FIND MANY USES AROUND THE HAM SHACK

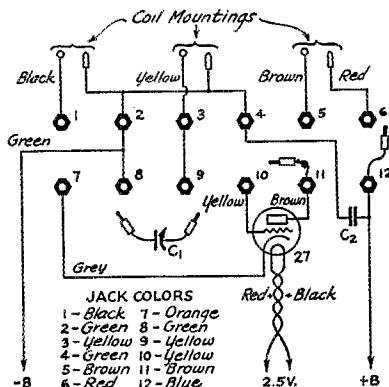

FIG. 1—CIRCUIT DIAGRAM OF THE MULTI-PURPOSE UNIT

Following is a list of the parts needed:
1 500- μ fd. variable condenser, C₁. Should be calibrated if capacity measurements are to be made.

1 vernier dial.

3 honeycomb-coil mountings (two hinged to vary coupling).

12 insulated pin jacks, colored (Yaxley).

4 'phone tips.

1 5-prong tube socket.

1 .25- μ fd. fixed condenser, C₂.

1 'Type 27 tube.

Four wire cable for power leads.

Set of honeycomb coils.

Metal cabinet.

solder in its construction, since the heat used in the enameling process often will melt the solder. If you have an enameling company finish this box for you on special order the cost will be pro-

*3919 Opal, Oakland, Calif.

wires. Everything I build is wired up with colored wire to a standard code I adopted for myself. This makes trouble shooting and alterations easier. Combined with the use of colored pin jacks and colored escutcheons it makes it easy to keep circuits in mind.

Only three circuits are suggested in Fig. 2, but any experimenter will think of others. The first circuit shows a regenerative detector using plug-in honeycomb coils. Besides its usefulness as a long-wave receiver, it is handy for calibrating. It is especially useful for the intermediate frequency bands of a home-built signal generator. You will use the fundamental and thus avoid mistakes caused by using the wrong harmonic. It is also valuable for calibrating a grid-dip oscillator.

By simply doing a little plugging we have the crystal oscillator circuit shown. I use Yaxley insulated tip jacks because they will take either the banana type of plug or 'phone tips. The meter in the cathode circuit shows when the tuned circuit is in resonance with the crystal by a dip of the needle. This meter is inserted in the circuit simply by plugging your analyzer meter cords in pin jacks 7 and 8.

The other circuit shown is one of a simple inductance shunted by a calibrated variable condenser. It can be used as an amateur-band ab-

sorption wavemeter by plugging in a short-wave coil instead of a honeycomb. Then this inductance may be coupled to the detector coil of a short-

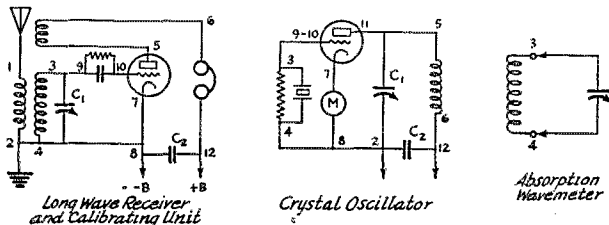

FIG. 2.—TYPICAL CIRCUITS READILY OBTAINABLE WITH THE UNIT

wave regenerative receiver and resonance found by the click method, or it can be used with a neon bulb or small flash lamp plugged in series with the coil and condenser. Such a wavemeter is not as accurate as the heterodyne type but is useful in making certain that the transmitter is not tuned to a harmonic.

Other uses for the circuit last discussed are in connection with inductance or capacity bridges and for capacity measurements with a grid-dip oscillator by the substitution method.

Dr. Jolliffe Discusses Cairo Arrangements

DR. C. B. JOLLIFFE, chief engineer of the Federal Communications Commission, granted an interview to representatives of the Federation of Radio Clubs during his visit to Los Angeles on August 7, 1935, taking as his subject the preparation necessary for an international telecommunications convention such as will take place at Cairo, Egypt, during early 1938.

In explaining the routine necessary for proper instructions, Dr. Jolliffe outlined the steps each country must take in order to be properly prepared for any aggression on the part of other nations. The first step in intra-national preparation, as far as the United States is concerned, is the selection of a preparatory committee, under the supervision of the Federal Communications Commission, which has for members representatives from each branch of the radio industry, including amateur radio.

The first move made by that preparatory committee is to assemble all proposals that meet with mutual approval, which are submitted through the State Department to the Berne Bureau, from where copies are circulated to all countries for examination. The next step is a conference consisting of this preparatory committee and the proposed delegates with the objective of discuss-

ing all other nations' proposals and to outline the United States' wishes in the proper form to combat any aggressive moves on the part of other delegations.

Delegates are appointed by the President of the United States, who has sole authority. The delegates, by common consent, divide themselves into committees so as to cover each phase of their work.

Dr. Jolliffe stated that preparation through the preparatory committee would begin during the latter part of 1936, and that delegates would be prepared by early 1937 to begin their formulation of plans for

Cairo. The delegates in attending these international conventions are instructed by the State Department when and what to sign in the name of the United States.

The State Department in issuing these instructions takes cognizance of the recommendations of the delegation. This is natural in view of the fact that the delegation is "on the ground" and is better able to picture the best course. The treaty after being signed by the delegates is then given to the Foreign Relations Committee of the Senate, where it is studied and then is brought to the floor of the Senate with the Committee's recommendation to ratify or reject. Ratification of a treaty must be made in entirety due to the fact that the delegations have agreed on the treaty as a whole before signing. After ratification by the Senate, the President issues a proclamation and the treaty becomes law within the borders of the United States.

An interesting feature is that outsiders are seldom asked to sit upon these convention delegations, who have already obtained full information in preparatory work. Dr. Jolliffe also stated that seldom after the consideration of foreign proposals released by the Berne Bureau, is it possible to alter the course to be pursued by the United States. So, therefore, amateurs should be fully prepared by early 1937 to make any recommendations or demands for more frequencies.

Also it is much more effective for amateurs to speak through one representative group, according to Dr. Jolliffe.

The Cairo Committee of the A.R.R.L., consisting of Directors Woodruff, Roberts and Bailey, have outlined their plans for preparation of the League's attitude toward the obtaining of more frequencies at Cairo. The committee can only direct the activity, it cannot be expected to do the job alone. Every amateur should take a vital interest in this matter and aid in every manner possible.

—Reprinted from 73 for September

With the Affiliated Clubs

Emergency

D. G. Goetcheus, President of the Binghamton (N. Y.) Amateur Radio Association, on July 8th was advised by the Red Cross that widespread destruction and loss of life had been caused by a flood at Whitney Point and Lisle, New York. A request was made for communication with some amateur station in that vicinity, all other facilities being disabled. Not knowing of any stations in that area, Mr. Goetcheus made arrangements to take a portable rig to Whitney Point.

The transmitter, furnished by W8BQX, consisted of a 59 crystal oscillator feeding a pair of '46's. The receiver was built into the same cabinet as the transmitter. A power plant consisting of six storage batteries driving a 32 volt d.c.-110 volt a.c. generator was furnished by Harry Spencer, ex-W8BVJ, and was contained in his truck. W8GPM, Mr. and Mrs. Goetcheus and Harry Spencer composed the party which took this gear to the stricken area. W8LKC, club secretary, had volunteered to act as Binghamton contact point and to notify other local amateurs of what was under way.

The emergency party arrived at Whitney Point, after encountering very precarious road conditions, and found practically all the village under six to eight feet of water. The gear was promptly set up on the side of a hill and communication established with W8LKC. W8MVD, W8IMR and W8CGW were also on the job at the Binghamton end. W8CGW, having best reception, acted as main contact station. Messages were handled for the sheriff and state troopers headquarters until late afternoon when a telephone line was finally run through.

Midwest Aviation Exposition

The St. Joseph Valley Amateur Radio Club of Mishawaka, Ind., provided 56-mc. communication at the Midwest Aviation Exposition at South Bend, August 3rd and 4th. The primary purpose was to keep officials in touch with all parts of the airport in case of accident. Fortunately there were no accidents, so the six stations of the club had little official business to handle. Communication was constantly maintained between the various stations, however, "just in case." The various stations were W9FHB, the central station near the announcer's stand, W9JHQ at the west hangar, W9LG at the east hangar, W9ESH at the western boundary of the field, and W9NNX at the east end of the field. One mobile station, W9KYM, was operated from the various roads surrounding the airport. This station rendered valuable service when a parachute jumper was carried beyond the field; W9KYM was dispatched

to observe the airman's landing and report in case assistance was needed.

Peninsula Amateur Radio Club

The Eighth Annual Regatta, under the auspices of the Hampton (Va.) Yacht Club, was furnished communication for its various events by the Peninsula Amateur Radio Club of Fort Monroe, Va. One station, W3AJA, set up on the judges' barge maintained communication with W3ATY at the club house, calling out races, starting entrants, paging various guests, and in general giving a bang-up good demonstration of 56 mc.

Radio Frequency Club

The Radio Frequency Club of Tiffin and Fostoria, Ohio, reports a very successful 56-mc. hidden transmitter hunt. W8CVZ/W8EAZ was installed in the Fostoria High School building and pushed a good signal into the air with a pair of ten's modulated by a 400-cycle tone, voice and phonograph pick-up. The antenna was a full wave vertical, five stories above the street. The gang assembled at Water Works Park in Fostoria. There were almost as many kinds of antennas as there were cars on the starting line. At 1:00 p.m. W8CVZ/W8EAZ came on the air and the cars scattered in all directions. In one hour and ten minutes W8ID and W8ENO, the winning crew, were parked outside the high school building. They used a tuned loop and spotted the location by taking bearings from two points outside the city. The only other successful crew was W8FWO and his brother, who came in twenty minutes later. At 3:00 p.m. the location was announced and in a few minutes the curb in front of the high school was lined with cars. After inspecting W8CVZ/W8EAZ the gang returned to the park where a picnic lunch was served. When the gang was starting for home W8CVZ/W8EAZ was again put on the air so that the maximum range of the signal could be observed. The greatest distance reported was nine miles, which is considered fair, as the terrain in that section of Ohio is all flat. This hidden transmitter hunt resulted in the creation of much new interest in ultra-high frequencies around Tiffin and Fostoria.

Hamfests

The Alberta Radio Experimenters Association and the Calgary Amateur Radio Association staged a hamfest at Calgary on July 12th. A good amount of entertainment made the affair extremely enjoyable. Code copying and "best mike voice" were among the contests held. General informal rag-chews were in evidence throughout the

(Continued on page 88)

Shifting Antenna Directivity by Phase Switching

An Effective House-Top System for 14 Mc.

By D. A. Griffin,* W2AOE

AS EVERY amateur is anxious to secure the best possible performance from his equipment, the trend is towards the use of directive antennas on the higher frequencies.



FIG. 1—THE VERTICAL ARRAY ON TOP OF THE HOUSE

Unfortunately, few of us have the space in which to put copies of the more elaborate arrays employed by the communication companies. Because many of the local gang were greatly interested in the writer's relatively simple 14-mc. skywire arrangement, particularly in the method used in its support and in the manner of shifting directivity, it is felt that *QST* readers generally might find it helpful; particularly those in crowded metropolitan or suburban areas where space is at a premium.

The writer's location does not permit the use of masts. The house being on the eastern slope of a hill, a variety of horizontal antennas running from the roof to the "extended clothes pole" in the rear of the house proved ineffective in working western 14-mc. stations. A horizontal half-wave antenna was then tried running between the 2-by-4 inch timbers (less the extensions) shown in Fig. 1. Some improvement was noted as a result of the increased height, but results were still unsatisfactory westward.

*10 Maple Place, Irvington, N. J.

Several *QST* articles have suggested the possibility of an increase in signal by the use of a directive system. Unfortunately, however, the space limitations prohibited their use. Another trouble would be that unless a rotary beam were used, transmission would have to be bi-directional along only one line.

However, the system shown in Fig. 3, using two half-wave radiators driven in or out of phase, gives a power gain of 40 percent and the shift in phase makes it possible to vary the pattern as shown in Fig. 4.

The first problem of major importance was how to erect two 35-foot sticks on the roof without having a mess of guy wires to distort the pattern badly; the second was to keep the weight down so that the base of the sticks would not be found in bed or in the kitchen sink some windy morning.

The answer to this was found in the use of bamboo poles. Thirty-five-foot poles cannot be obtained. However, 20-footers approximately 1 inch in diameter at the butt and $\frac{3}{8}$ inch at the tip can be secured. The butts of the 20-footers were inserted in the ends of 8-foot pieces of bam-

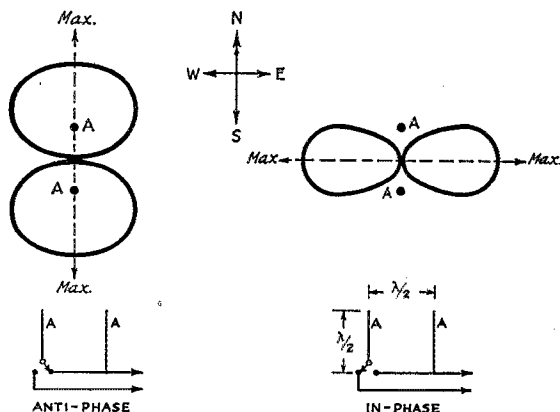

FIG. 2—THE PHASE-SWITCHING ARRANGEMENT IS WORKED BY CORDS RUNNING TO THE BASEMENT

boo 2 inches in diameter, the butt seating at the first joint approximately a foot below the top of the 8-foot pieces. Small pieces of wood were forced down alongside the butt of the top piece and the

joint wrapped tightly with wire to prevent splitting. A dowel about 2 feet long was then put half way into the bottom of the 8-foot piece of bamboo and another 8-foot section was slipped over

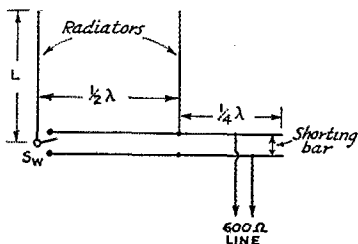

FIG. 3—SCHEMATIC OF THE ANTENNA SYSTEM

The dimensions for 14,200 kc. are as follows: $\frac{1}{2}\lambda = 34' 8''$; $\frac{1}{4}\lambda = 17' 4''$; $L = 33'$. ($L = 0.95 \lambda / 2$.)

the other end of the dowel. This joint was also wedged and wrapped with wire. The result was two 35-foot sticks that could easily be lifted with one hand.

The radiators were then run along the poles and the poles hoisted to the roof and lashed to the 2-by-4 inch timbers already conveniently in place $\frac{1}{2}$ wave apart in a north-south direction.

Considerable misgiving was felt concerning the amount of whipping the tops of the sticks would do in a strong wind. Because of the small amount of wind resistance, however, they have never been observed to swing more than 2 feet off center at the tip; and, strangely enough, the motion is rotary, not a "linear" whip as would be expected. Poles of this type are inexpensive and sturdy and seem to be ideal for vertical antennas on amateur frequencies higher than 7 mc.

The 20-foot "fish poles" can be obtained from hardware stores and suppliers catering to pigeon fanciers, who use them in training birds. The shorter lengths of larger diameter can be secured from rug stores or department stores, or the whole lot may be obtained from a bamboo importer if one happens to be located near by.

PHASE SWITCHING

The second problem was to provide means to switch one of the radiators from one feeder to the other from the cellar, where the transmitter is located, so that the direction of the pattern could be shifted readily. Fig. 2 shows the arrangement which was made up with knife-switch contacts mounted on insulators. The arm of the switch, also mounted on an insulator, connects to the antenna and the two contacts to the ends of the two feeders. The cross piece has two pulleys mounted on it. Strings run through them and are tied to the switch arm. These strings run through another pair of pulleys over the edge of the roof down to the cellar. A yank on one string quickly shifts the antenna pattern 90 degrees—east-west to north-south, or *vice versa*.

The method of feeding power to the radiating system was described some time ago in *QST*.¹ The $\frac{1}{4}$ -wave matching section with shorting bar and 600-ohm transmission line require no elaboration here.

Operation with the system proved most gratifying, reports from the west coast being materially increased over those obtained with previous antennas. A number of tests have been made with midwest stations who, while they can get an R4 or R5 signal on the north-south pattern with the antennas in opposite phase (because of the relative broadness of the radiation lobes), invariably jump the reports to R8 or R9 when the pattern is switched around 90 degrees by connecting the radiators in phase to give east-west directivity. Since the radiators are slightly over $\frac{1}{2}$ wave above ground, B.C.L. interference did not increase, usually a difficulty with vertical radiators. For the same reason the system is pretty well in the clear insofar as trees, houses, and other surroundings are concerned. Results are undoubtedly much better than those that could be obtained if the system were only $\frac{1}{4}$ wave above ground.

¹*QST*, July and Nov., 1934, Feb., 1935.

Southeastern Division Convention

October 11th and 12th, Alcazar Hotel, Miami, Fla.

ONWARD TO MIAMI is the slogan being heard over the air these days. The Miami Amateur Radio Club is sponsoring the annual convention this year and those who attended the convention last year know the impression made by the Miami delegation. The program is complete and many interesting features will be in evidence all through the two days. We are assured the attendance of John L. Reinartz, W1QP and he is coming prepared to give one of his best talks. A.R.R.L. will be represented by A. A. Hebert, Treasurer and Fieldman. License Examinations will be conducted so those of you anxious for a Class A will have an opportunity to try their luck. A big tour is planned for Saturday afternoon whereby the Pan American Airways will be visited, Coral Gables, the big Tropical Radio Station, and other interesting points. Entertainment is the key-word for this convention and a cordial invitation is extended to all amateurs to be with us at the Alcazar Hotel, Miami, Fla., October 11th and 12th. Further information may be obtained by writing Mr. E. J. Carmichael, 520 Olympia Bldg., Miami, Fla.

Strays

Tell the 160-meter boys that I worked more DX on 160 meters in 1924 using the faithful 202 than I've worked during the past year on 7 mc. with a 203-A!

—W5JP

How to Count Countries Worked

A New DX Scoring System

By Clinton B. DeSoto*

THIS piece has been started half a dozen times in the past five years. It has been the subject of more celebration and contemplation and tabulation and plain downright misery than one cares to recall. It is presented now—in a form far from what we should like it to be—only to silence the insistent demand that has come down through the years. “How about a list of countries of the world?” “How do I count countries worked?” “Are Tasmania and Australia separate countries?”—and a hundred variations of this latter. With the world WACing at a terrific rate these days, faster by far than ever before, the number of countries worked is increasingly becoming the criterion of excellence among outstanding DX stations.

How, then, do we count countries worked? The simplest way, of course, is to check against a standard list of countries of the world. Well, back in 1932 we began the preparation of such a list. We laid down fairly definite rules as to what constituted a country, and proceeded to tabulate the countries of the world. When we had reached several hundred, with the end not yet in sight, we hollered, “Whoa!” and decided that there must be some other better method. We knew that there were not more than 150 countries in which amateurs had ever been worked; it might be possible to list only them. But we had no assurance that amateurs would not encamp in some of the many remaining countries and thus render our list obsolete. An even more pertinent disadvantage was that it seemed impossible to even list all the countries in which amateurs had been worked to date; new countries were always popping out, astonishingly, like jack-in-the-boxes. Able coöperation was enlisted—Eric W. Trebilcock of Moonta, South Australia, Arthur W. Braaten, W2BSR, O. M. Carter, W9ADN, and others sent us lists they had prepared. We got lists of countries actually worked from such outstanding stations as WSBKP and W1TW-W1CMX-W1BUX and others. But it seemed no list was ever complete; even if brought up to date for a moment, it rapidly became obsolescent. And amateurs were still clamoring for a list of countries of the world!

The next attempt occurred in 1934, in an endeavor to rationalize and unify action on WAC applications by member-societies of the I.A.R.U. A tentative list of some 150 countries, limited strictly to continental mainland boundaries, was prepared and submitted to the member-societies.

* Assistant to the Secretary, A.R.R.L.

Even this list, restricted as it was, was not satisfactory; indeed, we almost immediately decided that the only satisfactory solution of this particular problem was a map of the world showing continental boundaries, which was prepared, approved by the membership, and published on page 41 of the November, 1934, issue of *QST*.

But this still left the problem of counting countries worked. Now, we could publish a list of all the “countries” of the world, but to be useful it would occupy seven or eight pages in *QST*, pages which are vitally needed for other material, and even then its utility would never reach a very high percentage. And the probable wear and tear on that copy of *QST* is enough to make one shudder!

The better plan, it seems to us, is simply to give the general rule we follow in deciding whether a country is a “country,” together with some pertinent examples, in order that each amateur will have enough information concerning standard practice to be able to prepare his own list of countries worked and have it uniform with other lists.

The basic rule is simple and direct:

Each discrete geographical or political entity is considered to be a country.

A few moments' consideration will serve to show that this is the only workable rule.

It is obviously incorrect to count prefixes alone (except for such purposes as the International DX tests where, paradoxically, confusion means simplification) because many places having the same prefix are quite widely separated geographically. In addition, confusion develops when a country changes its amateur prefix, with the result that an amateur might claim two countries worked whereas only one is proper.

It is obviously incorrect to accept either geographical or political divisions alone, as immediately the most glaring inconsistencies appear. The only general solution that comes anywhere near to solving the problem seems to be to reduce the definition of “country” to the smallest common denominator—a single unit in the world's geographical and political proportions. This has the added advantage—from the ham viewpoint—of creating a long list, offering the widest possible realm of achievement; and who will fail to find that an attractive feature?

To illustrate how this rule works out, a few general problems which have been raised in correspondence will be cited:

Alaska and the United States are separate because of the geographical division, just as Mexico and the United States are separate because of the political boundary.

Tasmania and Australia are separate because of the geographical division.

ZS, ZT, and ZU are counted as one country, because there is no geographical and political distinction; ZE, on the other hand, is a separate country.

Scotland and England are individual countries, as are the Irelands.

Sumatra, Java and Borneo are separate, as are Celebes and New Guinea.

Porto Rico and the Virgin Islands are each separate.

The Federated Malay States are one country, having a common government and being geographically connected.

Some distinction between *islands* and *island groups* is necessitated. Island groups, constituted by several islands commonly grouped under one name and under the same political control such as the Hawaiian Islands, the Tonga or Friendly Islands, the Sandwich group, etc., are regarded as one country. Where these groups are under different governmental control, they are subdivided into as many countries as there are governments. Individual islands, such as Bounty Island, Trinidad, Ascension Island, Amsterdam Island, etc., are regarded as separate countries. The principal place where this differentiation is likely to cause trouble is among the Pacific Islands, but even here the rule is found to apply remarkably well.

The few examples given will be found to illustrate the working of the method quite effectively. If any questionable points arise, A.R.R.L. headquarters will be glad to offer a ruling.

PROPOSED DX SCORING PLAN

Now we come to a somewhat different, although an allied, subject, broached by N. M. Patterson, W4EG. He is perturbed, and it seems many DX men agree with him, over that fact that under the countries-worked plan one VK QSO from America counts for as much as working all eight VK districts. Similarly, the European ham with one lone W QSO gets as much credit as another who has worked all nine call areas. "That there is a whale of a difference you will readily see," he writes through Director Cave-ness.

In view of this situation, W4EG proposes that there be created a "rule for counting DX, to be known as the *DX Score*." This score will be computed by taking the number of districts worked in each country, and adding it all up into a grand total. For example, we'll suppose that W8BKP, who had when last reported worked 123 countries, counts nine W call areas, eight VK districts, six Spanish districts, etc. On the basis of

adding the figures for these countries alone, the score would be 143; probably the grand total would be well over two hundred.

This seems to us to be an entirely rational suggestion, far more so than many that have been perpetrated. For ten years or so it has been impossible to work any *farther*, in terms of terrestrial miles; the only room for expansion is to work as many *places* as possible. The first recognition of this fact resulted in the inauguration of the WAC certificate. Totalling the number of countries worked followed naturally. This new proposal, expanding and improving the countries-worked idea, seems to be a logical next step. Indeed, following along this line of thought, one foresees the time when DX will be counted in cities worked, or stations per square mile, or something even more fantastic!

But for the present the DX Score idea looks pretty hot. It has the major beauty of simplicity. Just total up the districts worked, and there you are! We expect it won't be long before a lot of QSL cards will bear the legend, "Continents worked: 6; countries worked: 66; DX score: 92."

What do you say, old man?

Strays

The service department of the RCA Manufacturing Company regularly gives a series of technical lectures for service men in various cities throughout the country. Amateurs are invited; indeed many amateurs have been attending the meetings and have found them interesting. This autumn, lectures are to be presented in sixty-six cities, a series of three in each city. Between August 19th and September 16th the technical features of new RCA Victor receivers were covered. Between September 23rd and October 21st lectures will be given on the technical features of the metal tubes. The third series will occur between October 28th and November 25th and will deal with practical applications of the cathode-ray oscillograph in connection with tuned circuits in radio receivers. Demonstration equipment will be operated. Amateurs who would like to attend may get details of the schedule from the nearest RCA Victor dealer.

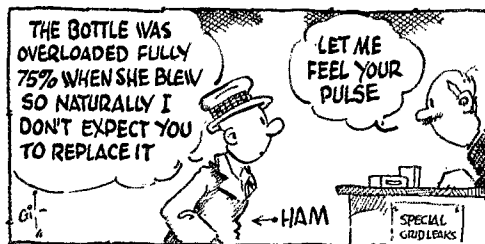

A Self-Powered V.T. Voltmeter of High Sensitivity

A Self-Calibrating Instrument for Peak Measurements Including Modulation Checking

By Don C. Duncan*

AS HAS been said before, and cannot be said too often, every advanced amateur should possess and use a vacuum-tube voltmeter. There is no simpler means for measuring all kinds of voltages, especially where it is important that the measuring device does not draw appreciable current from the circuit being measured.

In casting about for a suitable circuit to be used in constructing a permanent instrument for the author's laboratory, some fourteen or fifteen papers appearing in all the important radio publications for several years back were studied. All the circuits studied had one or more serious faults, such as poor accuracy on low a.c. voltages, inflexibility, and difficult and/or unstable calibration. The voltmeter to be described is a combination of several circuits, with innovations added, which seems to eliminate all the major shortcomings found in those voltmeter circuits which were studied.

The design finally arrived at is a peak-type instrument including a d.c. amplifier which gives greater sensitivity while protecting the indicating meter from overload, the voltage measurement range being from a fraction of a volt to several hundred volts. The peak measurement is obtained, of course, in terms of the d.c. voltage required to equalize the peak value of the unknown input voltage, the d.c. voltage being adjusted conveniently by a potentiometer and indicated directly by the voltmeter incorporated in the circuit.

CIRCUIT DESCRIPTION

The circuit of this peak v.t. voltmeter appears in Fig. 1. The input tube T_1 is biased to plate current cut-off. Tube T_1 is connected to the output of T_1 and acts as a d.c. amplifier. The Type 80 tube provides the d.c. plate voltage for tube T_1 , and has been added to afford portability and convenience.

A series condenser C_1 with shorting switch, is provided in the input circuit to isolate d.c. voltages when desired, as when measuring audio amplifier voltages or the hum or ripple voltage across a rectifier output. A shunt resistance R_2 is provided to give the grid a d.c. return when C_1 is used, or when the external circuit will not furnish a d.c. path. Of course if the voltage being measured is of a low (audio) frequency, a correction must be applied when the series condenser is used. This can be calculated, if the value of the series condenser and shunt resistance are accurately known.

The potentiometer, R_1 , provides the means for adjusting an external d.c. source to give the negative potential necessary to just balance the voltage being measured, the value being indicated by the two-range d.c. voltmeter. Switch S_2 can be the type associated with the potentiometer R_1 , and operated by the same knob.

A small 4½-volt "C" battery is wired into the input. The purpose of this battery is to bias tube T_1 to plate current cut-off. Since there is no drain on this battery, its life should exceed one year. Vernier adjustment of the plate current cut-off is accomplished by variation of the screen-grid voltage, using control R_3 . The method of making this simple adjustment will be described later.

R_2 forms part of the output circuit of tube T_1 ; it also forms the input to tube T_2 . With T_1 operating near cut-off, the d.c. voltage drop across R_2 is small, and T_2 will be operating at maximum plate current, which will be indicated by the milliammeter in the plate circuit of this tube. The range of this milliammeter

(0-5) was selected such that this maximum plate current provides almost full-scale deflection. A very small increase in the plate current of T_1 , due to a small voltage applied to the input, will cause a relatively large increase in voltage drop across

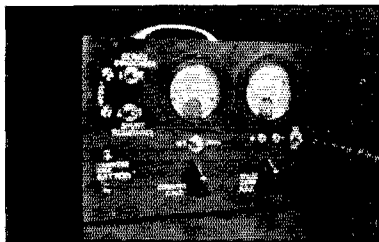

GOOD ACCURACY, HIGH SENSITIVITY AND AUTOMATIC SELF-PROTECTION OF THE INDICATING INSTRUMENT ARE FEATURES OF THIS PEAK V.T. VOLTMETER WHICH HAS UNIVERSAL APPLICATION IN AMATEUR WORK

It is especially useful for 'phone transmitter checking and provides that necessary means to insure proper modulation.

*Illinois Bell Telephone Company, Centralia, Illinois.

R_3 . This in turn will cause a sharp reduction in the deflection of the milliammeter in the plate circuit of T_1 . By adjustment of R_1 , the milliammeter pointer can be brought back to its original reading, or "false zero." When this is done, the reading of the d.c. voltmeter will be equal to the

After adjustment of R_3 , note the exact scale reading of the milliammeter. This is the "false zero." Close S_3 , and using the appropriate d.c. voltmeter scale, adjust R_1 to give a higher counter-voltage than the expected peak value of the unknown voltage to be measured. This will protect tube T_1 from abuse caused by making its grid excessively positive by a large input voltage, when that is connected first. Now connect the unknown voltage to the input. If this voltage is d.c. or has a d.c. component, connect the positive side toward the grid. Next vary R_1 until the milliammeter returns to the "false zero" reading. The reading of the d.c. voltmeter will now be equal to the peak value of the unknown voltage. Assuming a sine-wave shape for the unknown voltage, the r.m.s. value of this voltage will be 0.707 multiplied by the measured peak value. Where voltages are being compared with one another, with the same signal, the peak value is all that is needed.

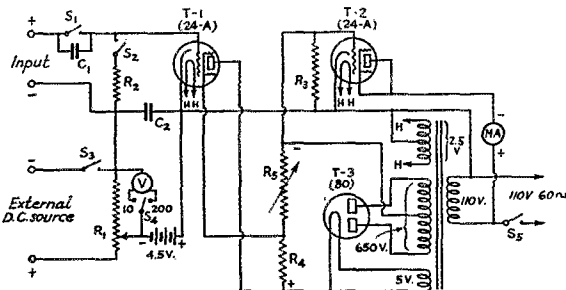

FIG. 1—THE VACUUM TUBE VOLTMETER CIRCUIT

- C_1 —0.001- μ fd. mica
- C_2 —0.001- μ fd. mica
- R_1 —10,000-ohm 6-watt wire-wound
- R_2 —1.0-megohm 1-watt
- R_3 —8000-ohm 1-watt
- R_4 —15,000-ohm 10-watt wire-wound
- R_5 —2000-ohm 2-watt wire-wound

peak value of the unknown voltage applied to the input of T_1 .

The plate supply voltage for T_1 is r.a.c. taken directly off the primary of the power transformer. The milliammeter in this circuit should have high mechanical damping, so that the pulsating current will not cause the needle to vibrate badly and thereby make reading difficult.

METHOD OF OPERATION

To place the instrument in operation, connect the 110-volt 60-cycle supply and operate switches S_1 and S_2 . When the tubes have warmed up, the milliammeter should give nearly full-scale deflection. Next, tube R_1 should be made to operate just above plate current cut-off by the adjustment of R_3 . Turn R_3 to its position of zero resistance. T_1 will now be operating below cut-off. Gradually increase the resistance of R_3 until the point is reached where the milliammeter reading begins to drop off sharply. This represents the point where plate current begins to flow in T_1 . Increase the resistance of R_3 until a reduction of 0.2 milliamperes is obtained. This adjustment, which is slightly above cut-off, is necessary for better sensitivity. Further increase of R_3 will reduce the sensitivity slightly, particularly on low input voltages. This adjustment of R_3 is not critical, however, and once adjusted for a particular set of tubes, needs no further attention. It may be well to check the adjustment at intervals, however, as it will give a positive indication that the voltmeter is operating satisfactorily, and will quickly show up a dead "C" battery or defective tube.

TYPICAL APPLICATIONS

An almost infinite variety of measurements is possible with this instrument. It is especially useful in checking both the r.f. and audio circuits of amateur transmitters, in which case it performs the functions of a "modulometer," as described in the A.R.R.L. *Handbook*. It can be used for checking directly positive-peak modulation, for instance. In this instance an r.f. pick-up with coupling to the transmitter's output circuit would be coupled to the "Input" terminals. Both positive and negative peak modulation percentages can be measured with the "Input" terminals connected across the load resistor of a diode linear rectifier, as described previously in *QST*. Further, the actual peak audio voltages (and, possibly, r.f. voltages) applied to the grids of the various tubes in audio amplifier circuits can be measured, thus providing positive checking for overload conditions that may be causes of distortion.

Used as a device to indicate resonance, as in lining up an i.f. amplifier in a superheterodyne receiver, resonance will be indicated by the point of greatest dip in the milliammeter reading. If the voltage applied to the input is more than about 2 volts, it will be necessary to add some d.c. counter-voltage with R_1 , in order to keep the milliammeter deflection within the sensitive range.

If it is desired to measure 60-cycle voltages from the secondary of a transformer which is connected to the same power supply as that which supplies power for the v.t. voltmeter, it will be found that a reading can be obtained only by one certain connection to the input. If the leads are reversed, no reading can be had. The

reason for this is that the plate supply of tube T_1 is not filtered, and fluctuates between zero and its peak value, at double power line frequency. The input connection to obtain a reading must cause the input voltage on the grid to reach its positive peak at the same time the plate voltage of T_1 does.

CONSTRUCTION NOTES

Most amateurs will have their own ideas on panel layout, and will want to apportion the space to accommodate the particular parts which they have on hand in their junk box. A few pitfalls will be pointed out, however, which will leave no serious obstacles in the way of planning and constructing a satisfactory v.t. voltmeter.

The original model was built into a cabinet of plywood, measuring 7 by 10 by 6 inches, with a 7- by 10-inch bakelite mounting panel. To permit circulation of air to cool the tubes, particularly the Type 80, the back was left partly open, except for wire screening. The Type 80 tube should be placed away from the panel meters to avoid heating them sufficiently to change their calibration.

If the input wire to the grid of tube T_1 is short and direct, it will keep the capacity of the input circuit low. At the ultra-high frequencies, appreciable input capacity is undesirable.

The earlier Type 24-A tubes (old shape bulb) will be found to be preferable. Several of the newer tubes had plate current cut-off characteristics which were not sharp. Tubes which have been replaced in b.c. sets on account of decreased cathode emission, will, as a rule, be fully satisfactory.

Do not shunt R_s with a by-pass condenser. This reduces the sensitivity of the instrument, and is unnecessary, because only a very small value of input voltage is reproduced in the output of T_1 , due to the unknown voltage being balanced out in the input by the d.c. counter-voltage. For the same reason, tube shields are unnecessary.

The usual panel engraving can be dispensed with by using a fine artist's brush and white enamel. A little patience will produce a commercial-looking job. The enamel can be wiped off easily while fresh, so that mistakes can be corrected.

When the v.t. voltmeter is not in service, the individual panel meters can be used independently. External connection to the milliammeter can be provided by pup-jacks or binding posts on the panel. The d.c. voltmeter can be used by connecting to the binding posts provided for the external d.c. counter-voltage source,

providing R_1 is set to include all its resistance.

This instrument possesses several advantages in addition to those generally found in v.t. voltmeters.

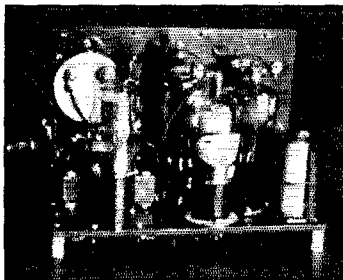

ILLUSTRATING THE COMPACT ASSEMBLY OF THE AUTHOR'S CONSTRUCTION

Note that the older Type 24-A tubes are used and that the 80 is kept away from the panel meters.

First. The ability to read small voltages accurately seems to be limited only by the accuracy of the d.c. voltmeter, plus the personal error in reading its deflection. To test this feature, a 60-cycle a.c. voltage of about 8 volts was placed across a tapped resistance, which divided the total voltage into increments ranging from 0.2 to 0.5 volts each. The sum of the measurements of these fractional voltages very closely checked the total voltage measurement.

Second. Good sensitivity is obtained. Sensitivity facilitates both accuracy and ease of adjustment, and in this instrument is indicated by the relatively large drop in the milliammeter deflection from its "false zero" position when a small voltage is applied to the input. In the original model, an input voltage of 0.25 volts a.c. dropped the milliammeter reading 0.2 milliamperes, which represents 4% of the 0-5 milliammeter scale range. An input voltage of 1 volt a.c. dropped the milliammeter deflection 1.0 milliamperes, or 20% of the scale range.

Third. There is no danger of damaging the milliammeter by sudden changes in the input voltage, or by accidental connections to the input, as would be the case in most v.t. voltmeters now in use. Any voltage applied to the input reduces the milliammeter deflection, instead of increasing it.

Strays

Colliers Magazine says that victims of hyperacusia can often hear a watch tick 30 feet away, 18 times the normal range of hearing. What an affliction for DX hounds!

—W50V

Dust settling on newly painted or varnished panels often dries in and mars the finish. While this can be avoided to a certain extent by drying the panels in a vertical position, the paint or varnish then has a tendency to run. These difficulties can be overcome by drying the panel face down on the sharp points of three or four lath nails which have been driven through a thin piece of board and placed face upward on a table or floor. Of course the usual precautions against raising too much dust should be taken.—W9PFQ.

A Homemade World Time Clock

By Elmer Newell,* W7AVM

FOR years a pet desire of mine has been to have a clock in the shack which would show the time in all the world zones as well as our own. Only a clock which would show the time in

between centers. This gave the necessary twelve to one reduction between minute and hour hands. To make this into a 24 to 1 reduction quite a few changes were required.

The first 2 to 1 reduction was left alone. The 12-tooth pinion was removed from the shaft of the 32-tooth second gear and a 16-tooth gear from the spare set was pressed on in its place. This was meshed with a 32-tooth gear also from the spare set. The 12-tooth gear on the shaft with this second 32-tooth gear is meshed with a 72-tooth gear from the spare set which acts as an idler. Any gear of the proper pitch and large enough to mesh with the adjacent gears may be used here as its only purpose is to cause the proper direction of rotation of the hour hand. A 72-tooth gear on the hour hand sleeve meshes with the idler, and the total reduction is the 24 to 1 which was desired. Without the idler the hour hand would run backward, which probably would be confusing.

Then the drawing instruments were dragged out (but not from the junkbox) and a new face for the clock, 14 inches in diameter and bearing figures from 1 to 24, was laid out on smooth white drawing paper. Incidentally, in drawing the figures, much time and work may be saved by taking a fairly large piece of glass and mounting it with a light under it. A sheet from a calendar with figures of a suitable size and design is placed on the glass and the drawing paper on top of it. After a little manipulation to locate the desired figure in its proper position its outline can be

(Continued on page 84)

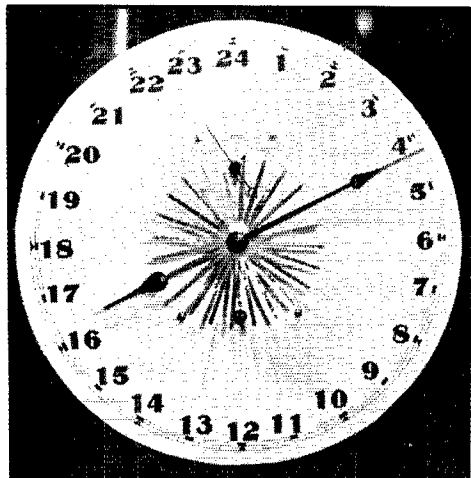

24-HOUR WORLD TIME CLOCK WHICH SHOWS TIME IN ANY ZONE AT A GLANCE

A series of pointers, spaced an hour apart and revolving with the hour hand, carry the names of the principal cities in each time zone. The principal change which must be made in an ordinary clock is the installation of additional gears to reduce the hour hand gear ratio from 12:1 to 24:1.

Greenwich, Calcutta or Berlin at a glance and without calculation would do. A combination of an old, high-grade clock movement, some extra gears from a duplicate clock, the *Handbook* Time-and-Date Slide Rule, and some ingenuity and elbow lubrication did the work.

The junkbox was found to contain an old pendulum type master clock movement, of excellent make and timekeeping qualities, also a dummy works containing a duplicate set of the reduction gears by which the hour hand is driven by the minute hand. Watchmaker hams will no doubt get some laughs out of the terms used to describe the various clock parts, for they have their own terms and names for them.

The hour hand was formerly driven first through a 16 to 32 tooth reduction, or two to one, and then back through a reduction of 12 to 72 teeth, or six to one, in gears of smaller pitch but having the same distance

* 2416 Aberdeen Ave., Aberdeen, Wash.

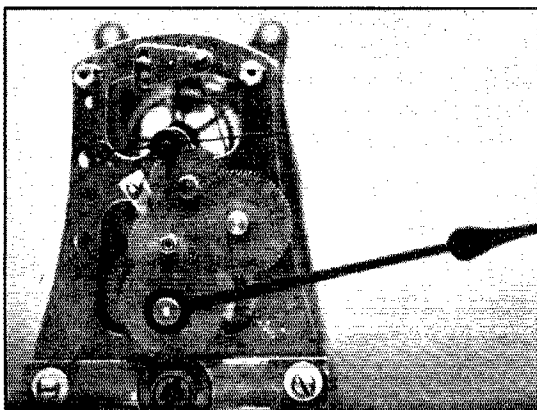

A CLOSE-UP OF THE HOUR-HAND GEAR ARRANGEMENT IN W7AVM'S CLOCK

The idler gear to give the proper direction of rotation of the hour hand engages with the gear on the sleeve directly back of the pointer.

Combined VK/ZL International DX Contest

1700 GT Saturdays to 1700 GT Sundays—Oct. 5–6; Oct. 12–13;
Oct. 19–20; Oct. 26–27, 1935

AS A result of the success of the 1934 VK "Melbourne Centenary Contest," R. H. Cunningham, VK3ML, this year announces another contest for 1935, jointly sponsored by the Wireless Institute of Australia and the New Zealand Association of Radio Transmitters. The hours of operating have been arranged to correspond to the international DX periods for both VK's and ZL's and limited to 24 hours per week as above indicated. An added feature is a special bonus of 500 points for any contact made with VK or ZL on 28 mc. There are 12 VK and ZL districts to be worked, so that the greatest possible score multiplier is twelve in this contest. Attractive certificates will be awarded the leading contestants in each country, to the winners of each licensing area in the U.S.A. and Canada, and to each in the British Isles. A new rule (13) will disqualify all hams trying to take part who use a selfish, broad, or modulated note such as some have persisted in using for contests in the past.

Contacts will be confirmed by the use of six numeral serial numbers with which all hams have become familiar in A.R.R.L.'s annual DX tests. Each operator allots himself a distinctive three number group (between 111 and 999), constituting half the six figure serial number. The other half, for the first QSO is 000. A number such as might be passed on for the first exchange is 852-000, for example. In exchange a participant will receive a similar number, and if there are numer-

als other than zero in the second half of the serial it will show that other stations have been worked before. The second half of the six-group serial number is taken from *the first three figures received on the previous QSO, added to the station's own three figure group, which are always sent as the first half of the serial number.* The executives of the N.Z.A.R.T. and W.I.A. invite amateurs all over the world to take part. Here are the rules and conditions:

1. There shall be two contests:
 - (a) Transmitting;
 - (b) Receiving.
2. The Wireless Institute of Australia Contest Committee shall be the sole adjudicators, and their rulings will be binding in the case of dispute.
3. The nature of the contest requires the world to contact ZL and VK.
4. The contest is to be held from 1700 GT, Saturday, October 5, till 1700 GT, Sunday, October 6, 1935, and will be continued over the same periods on each of the following three week-ends. The dates of the other week-ends are October 12–13, October 19–20, and October 26–27, 1935.
5. The contest is open to all licensed transmitting amateurs and receiving stations in any part of the world. Unlicensed ship and expedition stations are not permitted to enter the contest. Financial members of the W.I.A. and its affiliated societies and members of the N.Z.A.R.T. only will be eligible for awards in VK and ZL.
6. Only one licensed operator is permitted to operate any one station under the owner's callsign. Should two or more operators operate any particular station, each will be considered a competitor, and must enter under his own callsign and submit, in his log, the contacts established by him. This debar persons from entering who have not a ham license.
7. Each entry must be signed by each competitor as a declaration of the above statement.

LOG: VK/ZL INTERNATIONAL CONTEST, 1935

Name Transmitter
 Address Input to P. A.
 Callsign Receiver
 Operating at Type of Aerial
 Station

| Date | Time G.T. | Band in KC. | Station Worked | Serial Numbers | | Signal Report | | | Points Claimed |
|------|-----------|-------------|----------------|----------------|----------|---------------|---|---|----------------|
| | | | | Sent | Received | QSA | T | R | |
| | | | | | | | | | |
| | | | | | | | | | Total |

To be multiplied by = Grand Total

The following is a description of my Station
 I hereby certify that I have operated during this contest in accordance with the rules laid down, have adhered rigidly to the regulations governing amateur radio in my country, and that the score and the points set out above are true and proper.

8. Each participant will assign himself a serial number of three figures, as detailed in the contest description. When two or more operators work the one station, each will assign himself a separate number.

9. All amateur frequency bands may be used.

10. Only one contact with a specific station on each of the bands during each week-end will be permitted.

11. Contacts may be repeated on each of the succeeding week-ends with the same stations in accordance with Rule 10.

12. Each contact must be accompanied with an exchange of serial numbers and signal strength reports, including: readability, strength and tone.

13. **HIGHLY IMPORTANT**.—The judges reserve the right to disqualify any station whose tone report is consistently given less than TS.

14. Scoring: Three points will be allowed for every contact completed with an exchange of serial numbers and signal reports. A special bonus of 500 points will be given for a 28-mc. contact; this is to be added on to the final score after multiplying as in Rule 15.

15. Australian and New Zealand stations will multiply their total score by the number of countries worked and the stations outside VK and ZL by the number of Districts worked in both countries; there being 12 in all, VK2, 3, 4, 5, 6, 7, 8, 9, ZL1, 2, 3 and 4.

16. No prior entry need be made for this contest, but each contestant is to submit a log at the conclusion of the test showing: Date, time (in G.T.), band, station worked, in and out serial numbers, in and out signal reports, and points claimed for each QSO.

17. Entries from VK stations must reach the W.I.A., 191 Queen St., Melbourne, C.I., not later than December 1, 1935, and the foreign logs no later than December 31, 1935. ZL entries must reach the headquarters of the N.Z.A.R.T.,

Box 489, G.P.O., Wellington, before November 25, 1935.

18. Awards: Attractive certificates will be awarded to the station returning the highest total in each country; to the highest scorers in each of the British Isles; and to the winners of each district of U.S.A., Canada, Australia and New Zealand. There will be no world winner.

19. Foreign stations should call CQ VK/ZL and the VK and ZL stations; CQ DX TEST.

RECEIVING (FOR S.W.L.'s)

1. The rules for the receiving contest are the same as for the transmitting contest, but it is open to members of any Short-wave Listeners' Society in the world; but only to members of the N.Z.A.R.T. in New Zealand. No transmitting station is allowed to compete in the receiving contest too.

2. Only one operator is permitted to operate only one receiver.

3. The dates, scoring of points, and logging of stations once on each band per week-end are subject to the same rules as for the transmitting contest.

4. To count for points, the call sign of the station being called, and the strength and tone of the calling station, together with the serial number and signal strength report sent by the calling station, must be entered on the log.

5. The above items must be filled in before points can be claimed, that is, it is not sufficient to log a station calling CQ or TEST. Verification of reception must be made in accordance with the conditions in Rule 3 above.

6. VK and ZL receiving stations cannot log any VK or ZL stations—only foreign stations. Foreign stations will enter up only the VK and ZL stations heard.

7. The awards for the receiving contest will be similar for the winners in the transmitting test.

8. Receiving logs are to be similar to transmitting logs.

Modulated Emissions Added to WWV Standard Frequency Service

Standard Audio-Frequency Tone With 'Phone Announcements on Wednesdays After October 1st

THE National Bureau of Standards provides a standard frequency service which is broadcast by radio. Beginning October 1, 1935, this service is given on three days each week, from the Bureau's station WWV, Beltsville, Md., near Washington, D. C. These radio emissions provide a standard for scientific or other measurements requiring an accurate radio or audio frequency, or time rate, and are useful to radio transmitting stations for adjusting their transmitters to exact frequency, and to the public generally for calibrating frequency standards.

On each Tuesday and Friday the emissions are continuous unmodulated waves (c.w.); and on each Wednesday they are modulated by an audio frequency. The audio frequency is in general 1000 cycles per second. (There are no emissions on legal holidays.)

Emissions on three radio carrier frequencies

are transmitted as follows: noon to 1:00 p.m., E.S.T., 15,000 kc.; 1:15 to 2:15 p.m., 10,000 kc.; 2:30 to 3:30 p.m., 5000 kc.

The emissions on 5000 kc. are particularly useful at distances within a few hundred miles from Washington, those on 10,000 kc. are useful for the rest of the United States, and those on 15,000 kc. are useful in the western half of the United States and to some extent in other parts of the world.

During the first five minutes of the one-hour emission on each carrier frequency, announcements are given. For the c.w. emissions, the announcements are made by telegraphic keying and consist of the station call letters (WWV) and a statement of the frequency; this announcement is repeated every ten minutes. For the modulated emissions, the announcements are given only at the beginning of the hour; they are

(Continued on page 88)

A Simple Neon-Tube Oscilloscope for Amateur Use

An Inexpensive Means for Checking 'Phone Modulation

By D. H. Vollmer,* W6CQH

REALIZING that the QRM conditions in the amateur bands could be improved a lot if a means was provided for the fellows actually to see their signals (particularly the 'phones) with apparatus that would not cost too much, a simple oscilloscope was designed which would respond to *all* of the required frequencies, without using an expensive cathode-ray tube.

Knowing that a neon tube responds to voltage changes with negligible lag, and that the so-called "Tunalite" (neon column tube) would serve the purpose if it would only show both sides of the wave, a neon tube was made up which would start its glow in the center and increase the glow both ways from center in proportion to the r.f. voltage rise. Fig. 1-A is a drawing of the tube. It has a diameter of $\frac{3}{8}$ inch, length 4 inches. The electrodes entering from each end are slightly separated at the center. Now when this tube is connected to the output tank of a transmitter, as in Fig. 1-B, any change in carrier amplitude will cause corresponding changes in the height of the glowing column. But the trouble here is that, though the glow column is constantly changing, it appears to the eye not to be changing, because the changes up and down are on top of each other. To get around this trouble, it was found that by viewing the neon tube in a mirror rotating on an axis parallel to the axis of the tube, the image of the tube would appear to slide across the mirror (which might be called the screen), giving a sort of linear sweep. This solved the problem.

The speed of the rotating mirror required was surprising when actually tested, because it does not need to turn nearly as fast as at first thought, four or five hundred revolutions per minute being fast enough for checking even the highest audio frequen-

* 5126 35th St., San Diego, Calif.

cies. Synchronizing is a simple matter of adjusting the mirror driving-motor speed.

The photographs and diagram of Fig. 2 illus-

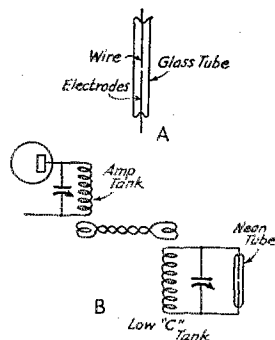

FIG. 1—THE ELECTRODE ARRANGEMENT IN THE SPECIAL NEON TUBE IS SHOWN BY A, WHILE B SHOWS THE CIRCUIT CONNECTIONS FOR R.F. CHECKING

trate the construction and arrangement of the unit. The upright that holds the tube is a piece of $\frac{3}{4}$ -inch wooden dowel, the front panel is Pressdwood (Masonite), the rest of the cabinet is sheet metal. The neon tube is mounted about $1\frac{1}{2}$ inches from the side of the metal cabinet; thus the metal does not disturb the operation of the tube.

The tuning condenser is a Pilot midget (100- μ fd.) mounted inside the coil; the knobs on the panel control an off-on a.c. switch and speed regulating rheostat for the motor. The motor is a "Polar Cub" fan type, but almost any small series motor can be used, even down to one from the lowly electric automobile horn.

In operation, the neon tube's tank is tuned to frequency of transmitter, the amount of coupling (with link) adjusted until the glow



CHECKING THE MODULATION OF THE 'PHONE TRANSMITTER IS JUST ONE OF THE JOBS THAT THIS HOME-MADE NEON-TUBE OSCILLOSCOPE CAN DO

The "picture" is viewed through the hole in the front panel. The dial controls the rheostat used to adjust speed of the motor.

runs about $\frac{3}{4}$ of an inch each way from center of tube. When viewed in the rotating mirror, the unmodulated carrier wave appears as a ribbon $1\frac{1}{2}$ inches wide. The edges of this ribbon will be very clean-cut and definite, providing no a. c. is

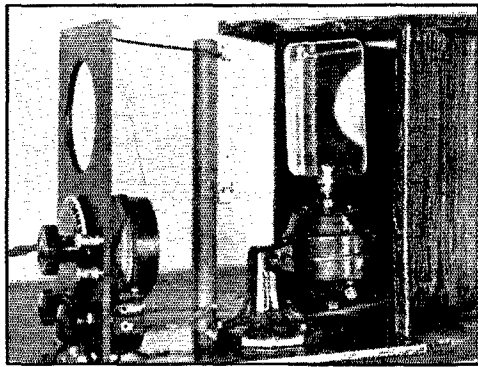

THE OSCILLOSCOPE PULLED OUT FROM ITS CASE, SHOWING THE SPECIAL NEON TUBE MOUNTED SLIGHTLY LEFT OF CENTER

The small fan motor, adapted to driving the mirror, is mounted behind it.

modulating the carrier and neutralizing is complete. A. c., or r. f. and a. f. feed-back, will show up as modulation lumps on the carrier band.

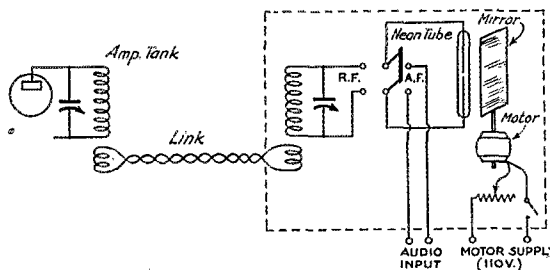

FIG 2—SCHEMATIC ARRANGEMENT OF THE OSCILLOSCOPE UNIT DESCRIBED IN THE TEXT

When audio modulation is applied as in a 'phone, a direct view of the wave form is obtainable, 100% modulation being easily recognized as with a cathode-ray oscilloscope. Insufficient r. f. excitation to the modulated stage is also very apparent.

Instructions for building this type of oscilloscope have been passed around to several Southern California hams, who have them in operation now and say that it has their complete indorsement, and that they would not take 50 bucks for theirs if they could not get another. These hams are W6CV, W6DZF, W6CSQ, W6EFD, W6KCE, and W6LKI.

I am now figuring on denating this neon tube design to some tube manufacturer (they would probably get it anyway), who will no doubt be

able to produce them to sell for a few cents. Until such can be done, I can supply them to the fellows who would want to construct their oscilloscopes now, but due to the necessity of hand work on the tubes, I will have to have somewhere between three and five dollars each for them.

Recently during the organization of a Chicago area High School Band, W9OZT, W9MCU, and W9MWV, playing flute, clarinet and piccolo, called CQ on their instruments. From the gathering of 200 musicians 5 hams and 2 SWL's answered with almost everything from piccolo to tuba! Not such a bad percentage.

W3AKE and W3IA are very close friends and spend much of their spare time QSO. When working at their occupations they are still QSO after a fashion, since W3IA is the dispatcher at a police radio transmitter in Philadelphia and W3AKE is listening to him while cruising around as a member of the radio patrol.

Two WOR engineers making field strength measurements for that station in the vicinity of Wilmington, Del., were arrested recently by the police as suspicious characters believed to be conducting short-wave communications in behalf of the bootleg racketeers. They were released for lack of evidence. It looks as if the P. D. has set out on a difficult task if it attempts to arrest the horde of hams in this section who will be travelling about the countryside during the next few months with portable five meter outfits.

—Charles E. Kane

Recalling the story of "Shooting the Works" which appeared in *QST* for January, W4BCU had the following experience: "W4BCL held a heavy oak board outside the window to act as a backstop for the bullet when the attempt to shoot the hole through the window glass was made. When I fired the rifle, the bullet left the gun, went through the glass, struck the board, bounced back through the pane and struck me on the side of the head! Investigation showed that the bullet went through the same hole twice, although the hole was smaller than the diameter of a lead pencil." Any other hams trying this stunt should be prepared to duck!

Senior op: "What's the matter, son, did you cut your hand?"

Junior op: "No, daddy, I picked up a pretty bug in the garden this morning and one end of him wasn't insulated!"



Amateur Radio STATIONS



W1FH, Everett, Mass.

ALTHOUGH W1FH dates but from 1930, this station will be found among the leaders in every DX contest. DX and rag-chewing are the speciality of its operator, Charles Mellen, Jr., of 14 Prospect St., Everett, Mass.

A good many transmitters have seen service at



W1FH

W1FH; in the latest outfit, shown in the photograph, two separate sets are used, one for 7 mc. and the second for 14 mc. The 40-meter transmitter consists of a 47 crystal oscillator, 503-A doubler, and an Eimac 150T final. The 14-mc. set also starts out with a 47 oscillator, has a first doubler stage using a 10, a 503-A second doubler, and also ends up in a 150T final. The plate voltage is 3500 on the final stages of both transmitters, the input being between 600 and 700 watts.

Separate Zepp antennas are used for each of the transmitters. The receiver is a National FB7A.

W1FH has worked 83 countries in all six continents, making WAC fifteen times in 1934. As related in our September issue, W1FH rolled up a score of 29,162 points in the 1935 DX Contest, winning the certificate in the Eastern Massachusetts Section and standing sixth in the country.

W6TI, Oakland, Calif.

WITH fifteen years of ham radio behind him, Horace Greer, W6TI, of Oakland, Calif., has a valid claim to being an old-timer—and he's still going strong. The layout at W6TI, as shown in the photograph, is an attractive one.

The rack at the left contains the r.f. part of the transmitter, the power supply, also rack mounted, being on the floor just outside the picture. A 59 Tri-tet oscillator drives a 10 doubler followed by a second 10 used as a buffer. The final stage has a pair of 203-A's in push-pull. The input is between 600 and 800 watts on both 20 and 40 meters. The antenna is vertical, 66 feet long, cut in the center for Zepp feeders which are connected to a Collins coupler at the set end. It is thus used as a half-wave vertical for 7 mc. and as two half-waves in phase on 14 mc.

The receiver will be recognized as a Hammarlund Comet Pro. Beside it at the left is a one-stage Sargent pre-selector.

The call 6TI has been held continuously since 1920.

W5DAQ, New Orleans, La.

THE owner of W5DAQ, J. Allen Swanson, Jr., of 4000 St. Charles Ave., New Orleans, originally started in amateur radio in 1926 with the call 5PM, using the then-typical 210 Hartley transmitter with a chem rectifier. Two years later



W6TI

the station was dismantled when its owner went abroad to live. On returning to this country the call W5DAQ was obtained, evolving, after several different rigs were tried, into the station pictured here.

The tube line-up of the frame-mounted transmitter consists of a 47 oscillator, 46 doubler, a third stage with two 46's in parallel, and a 203-A

final. Three separate power supplies are used for the oscillator, intermediate and final stages. The 203-A gets 1000 volts at 180 mills from a power supply using 81 rectifiers and a two-section choke-input filter. The whole outfit, including the power supplies, is contained in the frame.

The antenna at W5DAQ is a 66-foot Zepp. The usual operating frequency is 7220 kc., with occasional excursions to 14,360. An SW-3 with home-made power supply takes care of the receiving end. The transmissions are continuously monitored, the monitor being on the small shelf on the wall between operating table and transmitter.

Chief interest of W5DAQ centers around traffic handling and work in nets, particularly in the recently-formed Mississippi Emergency Net. The chance for DX contacts is not overlooked, however.

W7BYW, Buhl, Idaho

CLARENCE N. LANE, owner of W7BYW at Buhl, Idaho, has operated under almost enough calls to give stiff competition to some of the claimants of the "most-calls-held" title. Starting with spark in 1919, he has been on the air as 7AHS, 7SL, 7ALF, 7ADA, and 7DV—nothing but 7's!

The frame-mounted transmitter shown in the



W9JIR

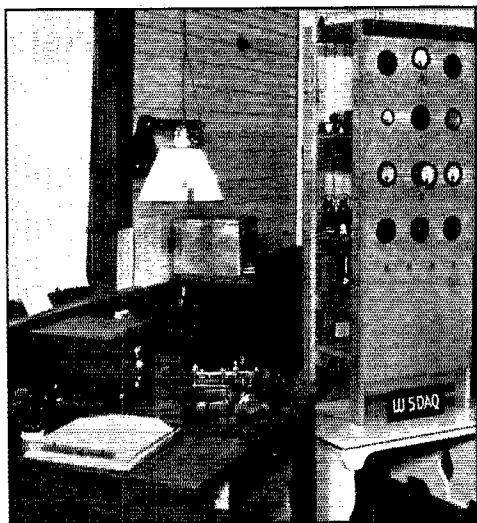

W5DAQ

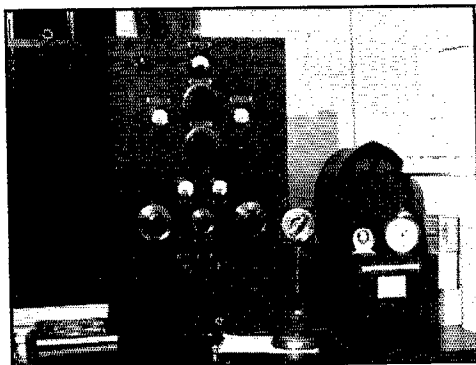

W7BYW

photograph consists of a 47 crystal oscillator, a doubler stage using a pair of 46's, two Sylvania 10's as a buffer, and a final stage using a pair of Eimac 150T's, operated with a full kilowatt input. Three power supplies are used, one giving 500 volts for the oscillator and doubler, a second delivering 1000 volts for the buffer, and the third 3000 volts for the final.

The antenna at W7BYW is a half-wave 3.5-mc. Zepp with 45-foot feeders, a system which has proved to be very effective on all bands. A half-wave vertical for 20 is under construction. Two receivers are in use, a PR-10 and an SW-3, the latter being used for hunting the distant weak ones.

W7BYW operates on 20 and 40 meters, the chief activity of the station being working DX. WAC has been made several times, 41 countries having been contacted. At this particular location Asia seems to be the only consistent continent, the others being "tough" enough to preclude any possibility of DX losing its kick.

W9JIR, Chicago, Ill.

A NEAT station for an unused room corner is W9JIR, pictured herewith, owned by Glenn E. Webster, 5860 Kenmore Ave., Chicago, Ill. W9JIR was put in operation in 1932 with a pair of 10's, replaced by an RK-20 when the latter was made available. The 20 worked so well on 14-mc. 'phone that the outfit was rebuilt in the table rack shown to use two of them.

The transmitter has only two stages, the first a 2B6 in the Les-tet circuit as an exciter, the

(Continued on page 100)



STRAYS



One of the latest of the many synthetic resin products is translucent Bakelite, a Bakelite which passes light. A sample furnished by United Radio Manufacturing Co. of 191 Greenwich Street, New York, one of the first firms to carry the new product, consists of a sheet of the translucent material faced with a thin veneer of regular black Bakelite. In engraving the tool cuts through the black veneer to the translucent Bakelite, which is pearly white in color, the finished job resembling ordinary whited-in engraving when illuminated from the front, but taking on a luminous character when lighted from behind. Some tricky transmitter decorations can be made by using the new Bakelite for nameplates, rear-illuminated, which flash up when circuits are cut in, etc.

Service men will be interested in two booklets recently published. These are "Sylvania Service Hints Booklet, Volume 2," and "Sylvania Auto Radio Service Booklet, Volume 2." Copies may be obtained without charge by writing to the Hygrade Sylvania Corporation, Emporium, Pa.

Three publications on theoretical and experimental electronics and electron-tube applications, originally published for educational institutions, are now available to the public at nominal charge from the Educational Section, General Electric Co., Schenectady, N. Y.

"Electronics and Electron Tubes," by E. D. McArthur of the G. E. vacuum tube engineering department, gives in easily-understood language the fundamentals underlying the vacuum tube, including simple experiments to illustrate these fundamentals. References are included to enable the reader to delve more extensively into many subjects treated in the booklet. This 48-page publication is designated as GET-568-A and is priced at 25 cents.

The other two publications, GET-566 and GET-620, deal with laboratory experiments on electron-tube theory and on electron-tube applications respectively. The former is intended as an experimental supplement to "Electronics and Electron Tubes," while the latter is a laboratory manual covering a number of fundamental electron-tube applications. The two booklets are obtainable as a combination priced at 25 cents.

New 2-Volt Battery Duo-Diode-Triode

A new tube of the duplex-diode-triode type has been added to the 2-volt battery-operated series,

according to an announcement from RCA Radiotron. Carrying the number 1B5/25S, it is designed to perform simultaneously the functions of detection, amplification and automatic volume control, and may be used in circuits similar to that in which the Type 55 is used. The rated filament current is 0.06 amperes. A maximum plate voltage of 135 and a negative biasing voltage of 3 are recommended. The triode section has an amplification factor of 20, with a normal plate current of .8 milliamperes. The tube takes a small 6-pin socket.

W9NUF—A Five-Meter Bike!

The photo below shows George H. Nibbe, W9NUF, all ready to take off on a five-meter jaunt à la bicyclette. Portable-mobile W9NUF uses a transceiver with a 19 in the unity-coupled cir-



cuit with grid modulation, the input being slightly under three watts. The signals have been heard over a distance of about two miles, several stations having been worked. The antenna, which probably won't show in the reproduction, is a four-foot vertical rod mounted on the board across the handlebars, and is worked against the frame of the bicycle.

No worries about ignition noise with this rig!

A pair of 6's working at a San Francisco store have the calls GIN and FIZ, which, says W6KBY, makes a darn nice combination!



Stabilizing the 2A7 Converter

The 2A7 (or 6A7) as a combined oscillator-mixer for high-frequency superhets has made a rather poor reputation for itself from the stability standpoint, particularly because of frequency changes with "B" voltage variations. While the instability is not so bothersome in 'phone reception, it becomes annoying in ordinary c.w. reception and makes satisfactory single-signal c.w. reception extremely difficult.

Wolcott M. Smith, of Springfield, Mass., has suggested the use of neon bulbs in a voltage-stabilizing circuit which maintains practically constant voltage on the oscillator-portion anode despite fairly wide changes in the plate-supply

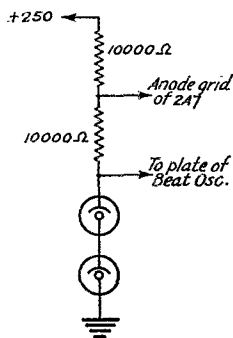

FIG. 1—NEON-BULB STABILIZING CIRCUIT FOR H.F. SUPERHET OSCILLATOR

The neon bulbs used are the spiral-element type with the series resistors removed.

voltage source. The major cause of oscillator instability is thereby eliminated. The circuit, shown in Fig. 1, consists simply of a voltage divider with two neon bulbs in series as one section of the divider. Fig. 1 also shows how plate voltage for the beat oscillator can be taken off the divider in addition to the voltage for the high-frequency oscillator.

The neon bulbs should be the new type having a spiral grid as one element. The older type with the small semi-cylindrical plates does not seem to work satisfactorily. The resistor in the base of the lamp must be removed; this can be done quite readily by filing around the base of the shell at the bottom of the threads and unsoldering the center connection.¹ The base then can be taken off and the resistor removed, the wire being soldered directly to the shell. The base may then

¹ Neon bulbs without the resistor in the base are now available. They are equipped with auto-headlight type bases to distinguish them from the regular candelabra-base lamps provided with series resistors.

be replaced, the center connection re-soldered, and some solder run around the filed part of the shell to keep the base in place.

Neutralizing the Final

A letter from E. A. Krall, W8CKO, points out a reasonable method of neutralizing a final amplifier to make sure that the amplifier is neutralized under the operating conditions—that is, with the antenna coupled—and that no back wave will be emitted. He writes:

"The procedure is quite similar to the regular way of neutralizing except that an indicating device such as a low-range r.f. ammeter or flashlight bulb is inserted in the antenna lead and the final is purposely pushed out of neutralization. Of course the plate voltage is disconnected. The neutralizing condenser is then turned until all indication of radiation disappears and further turning in the same direction causes it to start to rise again. The optimum point is naturally the zero setting between the two settings which show antenna current.

"Using the above method, no trouble is experienced in neutralizing a W.E. 212E on 20 meters. Out of neutralization the 852 buffer pushes over an amp into the antenna, and it's just like rolling off a log to neutralize this high-capacity tube on 20. Similar results were obtained using a 204A in the final. Anyone who has worked me on 40 or 20 will vouch for the fact that I have no back wave."

Midget Portable Receiver

While it is rather late in the season to talk about portable sets, the circuit of the receiver used at VE4EA may be of interest. The outfit uses two 2-volt tubes and, complete with batteries, fits into an aluminum case measuring only $4\frac{1}{2}$ by 6 by 7 inches. Although the plate voltage is only $13\frac{1}{2}$, the receiver operates well on all frequencies up to at least 25 mc.

As the diagram shows, the set consists of a regenerative space-charge detector and one stage of audio. The secret lies in the use of the space charge detector, which enables real results to be obtained with low plate voltage.

The space charge idea was tried out a few years ago, but it was not used very extensively because no suitable tubes were available; however, there are several now that seem to be just what the doctor ordered. The 46 and the 49 are examples. Both of these tubes have two grids, but they are

not screen-grid tubes; the latter types are not satisfactory because of high plate-to-screen capacity and other reasons (see *Radio Engineering*, Terman).

Now for a few details. The circuit is fairly conventional except for the inner grid in the 49, which has positive bias applied to it to cancel

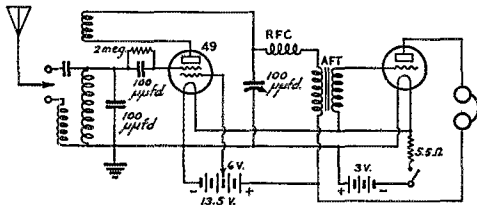

FIG. 2—SPACE-CHARGE REGENERATIVE DETECTOR IN A LOW-VOLTAGE TWO-TUBE PORTABLE

Regular manufactured coils can be used in the detector circuit, since tickler turns are not critical. Both antenna coil and coupling condenser are used, the former on the lower frequencies and the latter on the higher frequencies, also depending upon the antenna. The coupling condenser need have a capacity of only a few micromicrofarads, and may be made by bending two small pieces of metal strip to face each other, with a spacing of about $\frac{1}{16}$ inch between "plates." The audio transformer used by VE4EA has a ratio of 3 to 1.

out the space charge to some extent. The outer grid is used as the control grid. The audio stage uses a 30, the filaments of both tubes being connected in parallel. Filament power is obtained from a bank of six No. 2 Unicells in series-parallel to give 3 volts. A fixed resistance drops the voltage to 2 volts. It had been decided to use four cells in parallel for filament supply, but the set didn't oscillate very well with $1\frac{1}{2}$ volts on the filaments, so the series-parallel arrangement was used. Three small-size $4\frac{1}{2}$ -volt "C" batteries are used for plate supply and they are strapped in the case wherever they fit. Standard manufactured sets of coils can be used as the tickler turns do not seem to be very critical.

It was noticed that the ratio of plate to inner grid voltages seemed to be fairly important, and that $13\frac{1}{2}$ and 6 seemed to be best. A bad fringe howl showed up when the plate voltage was reduced, although the tube still would oscillate with 9 volts on the plate. The total plate and inner grid current is $5\frac{1}{2}$ milliamperes and the filament current is .18 ampere, so battery life should be fair. An attempt to control regeneration by varying the inner grid voltage did not work very well, although it represents a possibility. As it is, the usual throttle condenser works satisfactorily except for a slight detuning effect.

—Roy Usher, VE4EA

Automatic Protection With Grid-Leak Bias

Phone men in particular will be interested in this bias scheme after reading Mr. Lent's excellent article on modulated Class-C amplifiers. As stated by Mr. Lent, linear performance of the

Class-C stage can only be secured when grid-leak bias is used and the grid is operated at the saturation point. Every amateur knows, however, that the bias voltage drops to zero when the grid excitation stops if a grid leak is used alone. The result often is a burned-out tube unless fuses or circuit breakers are employed.

The circuit shown in Fig. 3 has been used by the writer in a 1-kw. transmitter for over a year with excellent results. In operation pure grid-leak bias is used, and if the excitation fails or a buffer stage is keyed for telegraph, cathode bias is automatically cut into the circuit, making it impossible for the amplifier to draw excessive plate current.

The proper value for R_1 , the grid leak, can be determined by Ohm's law. For example, if the bias voltage required for Class-C operation is 150 volts and the grid current required is 50 ma., E divided by I gives 3000 ohms. The value of R_2 ,

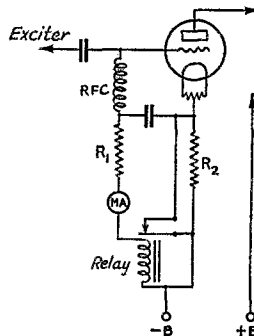

FIG. 3—PROTECTIVE CIRCUIT FOR GRID-LEAK BIASED R.F. AMPLIFIERS

R_1 is the regular grid leak, R_2 a cathode resistor to limit the plate current under no-excitation conditions. When grid current flows through R_1 and the relay winding, R_2 is shorted out, but is cut into the circuit should grid current cease. The condenser between R_1 and R_2 is the ordinary r.f. bypass.

which develops the cathode bias for tube protection when the amplifier is not delivering power, cannot be calculated quite as simply. Cathode bias is dependent on the amount of plate current flowing, so the plate power which the tube can dissipate safely must be used as a guiding factor. If we take a 203A as an example, the maximum safe dissipation is 100 watts. Then if the plate voltage is 1000, the maximum safe plate current is 100 ma. If we reduce the plate current to 50 ma. we then have a conservative dissipation of 50 watts when the tube is idling. Since the bias voltage required to reduce the plate current to 50 ma. is approximately 50 volts, as shown by the tube characteristic curves, by Ohm's law R_2 should be 1000 ohms.

The relay employed to short-circuit the cathode bias resistor should be adjusted so that the contacts will close on approximately 70% of the normal grid current. This adjustment can be

made before the plate voltage is applied. Sufficient spring tension must be used so that the relay follows the keying perfectly. In operation, bias is secured from the voltage drop across R_1 ; the rectified grid current actuates the relay, short-

apart, since no adjustment can be made on the inside which will correct the condition.

—Robert M. Ellis, W5ETC

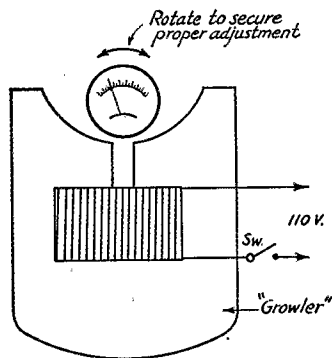

FIG. 4—REMAGNETIZATION OF READRITE-TYPE METERS

circuiting the cathode-bias resistor, R_2 . With no excitation no bias is secured from R_1 , but the plate current flowing through R_2 provides a limiting bias for tube protection, with the plate input held down to a safe value.

—D. A. Griffin, W2AOE

Remagnetizing Readrite Milliammeters

A temporary short, flash-over, or mechanical shock will sometimes demagnetize a Readrite meter so that the pointer will "bottom up" somewhere in the middle of the scale, instead of at zero. When this condition occurs, the meter can be repaired without even removing the movement from the case. It is only necessary to have access to a "growler"—a device used in automotive repair shops for testing armatures for a short or ground.

Set the meter between the jaws of the growler as shown in Fig. 4, the current to the growler being turned off. Snap the current on and off the growler as quickly as possible. Remove meter from growler and note where the pointer comes to rest. This will probably be one side or other of the zero mark. Replace the meter in the growler, rotating it slightly from its previous position. Snap the current of the growler on and off. Remove meter and examine. This time it will be found that the pointer comes to rest at a slightly different position. With a few trials a position can be found where the pointer will return to zero and the meter will be as good as new.

Readrite milliammeters do not use a spring to return the needle to zero, this function being taken care of by a small permanent magnet inside the meter case. Consequently, in case of demagnetization there is no use in taking the meter

Continuous Monitoring With the Regenerative S.S. Super

A method of monitoring transmissions which requires no switching, relays, or in fact any extra apparatus except the receiver and the regular heterodyne frequency meter has been devised by J. Stanley Brown, W3EHE. The transmitter is heard whenever the key is touched, the operation of the receiver being unaffected in any way. W3EHE writes as follows:

"Some good schemes of continuous monitoring have come out, but it is seldom that they made use of only essential apparatus and did not require a lot of relays, additional click filters, etc. A method of accomplishing the desired result is in use here and working OK within a few feet of a transmitter with 100 to 125 watts keyed input.

"The receiver used is a variation of James Lamb's regenerative single-signal job with an r.f. stage added. Except for a separate single wire receiving antenna, at right angles to the regular transmitting Zepp, the only other piece of equipment used is the station freqmeter. A front-of-panel pin jack is connected to the cathode end of the i.f. regeneration control resistor, and a 'phone cord connects this jack to the output jack on the freqmeter or monitor. The freqmeter is tuned to intermediate frequency higher or lower than the transmitting frequency and the signal comes out of the usual receiver output circuits.

"If it is too loud, coupling to the transmitter can be changed or, better still, just turn the regeneration control and shunt some of the signal voltage to ground. With all of the resistance cut out the signal goes to zero. This circuit arrangement also makes a good 'phone monitor.

"A few points about the operation: The strength and stability of the monitored signal is independent of the r.f. tuning adjustments of the receiver. It works up to within two or three kc. of the transmitting frequency before being blocked out, and can be used at the transmitting frequency if the plate voltage on the r.f. stage is cut off with a switch. The r.f. gain control can be used for similar results.

"Keying of the crystal oscillator in the cathode is one of the best ways of getting rid of key clicks, although even then some click filter usually is necessary. This system of monitoring and break-in is at its best only when key clicks are practically eliminated."

TNT "R" Circuit

A variation on the "R" circuit which should be of interest to fellows using locked oscillators, suggested by Fred C. Allen, VE3SA, is shown in

Fig. 5. The crystal is simply coupled through a small coil to the cold end of the grid coil of the

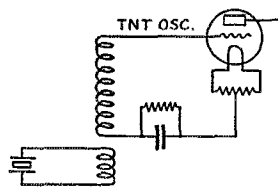

FIG. 5—TNT CIRCUIT WITH CRYSTAL LOCK

ordinary TNT oscillator. No changes are required in the oscillator itself.

VE3SA uses a coupling coil of seven turns on a tube base closely coupled to the 60-turn grid coil on the same form (3.5 mc.). The oscillator is a Type 50 with about forty watts input. The crystal load can be adjusted to a safe value by changing the coupling between the two coils, either through variation of the spacing or by changing the number of turns on the crystal coupling coil.

"B" Power for the Keying Oscillator

A simple method of supplying plate voltage, for an audio keying oscillator—and incidentally keying the oscillator as well—is shown in Fig. 6. It is a suggestion of J. C. Nelson, W8FU, who is using it with a single 46 in the final stage.

The resistor R is a variable having a value of about 400 ohms. It is simply adjusted to give sufficient plate voltage for the audio oscillator.

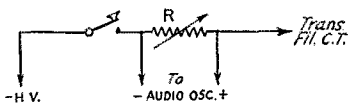

FIG. 6—A CIRCUIT FOR OBTAINING PLATE VOLTAGE FOR AN AUDIO KEYING OSCILLATOR

Besides eliminating the necessity for a plate supply for the oscillator, this system requires no keying relays.

Since the resistor acts as a cathode biasing resistor, it is desirable that the voltage drop across it be kept as low as possible. Since the audio oscillator should not require more than 20 or 30 volts, the drop in plate voltage can be considered negligible.

One advantage of the system is that no keying relays are required to take care of the audio oscillator.

Simple Keying Oscillator

At one time or another every amateur wishes to have some means of listening to his keying, especially when using a bug. Although it may be pointed out that a monitor can be used for this purpose, the usual heterodyne monitor often turns out to be unsatisfactory with a crystal con-

trolled transmitter since the keyed signal many times cannot be distinguished from the continuous signal from the exciting stages.

The audio oscillator described here is the height

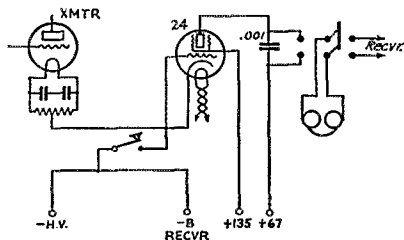

FIG. 7—A DYNATRON AUDIO OSCILLATOR FOR MONITORING KEYING

The audio tone obtained will vary with different types of headsets and with the capacity of the fixed condenser in the plate circuit. It should be possible to change the tone over a fair range with a given headset by varying the capacity.

of simplicity and has been in use at W2DBQ for a number of years. It makes use of a dynatron audio oscillator which is keyed simultaneously with the transmitter. No relays are used. Power is supplied from taps on the receiver "B" supply. A small bakelite panel on the operating table holds the double-pole double-throw switch for the 'phones.

The only pitfall to watch out for is to be sure that negative sides of both the "B" supply and the transmitter power supply are on the same side of the key. If they are put on opposite sides, the dynatron oscillator will act as a high resistance in the center tap of the keyed transmitter stage, and will permit the tube to draw low plate current. It will be seen that this system can only be installed where center tap keying is utilized; no experiments have been conducted in regard to using it with grid block or other keying systems.

—Richard E. Nebel, W2DBQ

The newer screen-grid tubes are treated to reduce secondary emission from the plate, essential to dynatron operation. An old tube from the junk box may do a better job than a new one.—Ed.

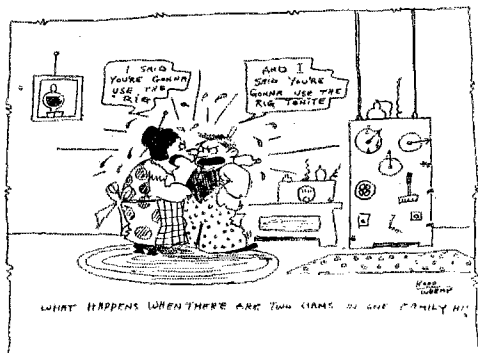

• I. A. R. U. NEWS •

Devoted to the interests and activities of the

INTERNATIONAL AMATEUR RADIO UNION

President: H. P. MAXIM

Vice-President: C. H. STEWART

Secretary: K. B. WARNER

Headquarters Society: THE AMERICAN RADIO RELAY LEAGUE, West Hartford, Conn.

MEMBER SOCIETIES

American Radio Relay League
Associazione Radiotecnica Italiana
Canadian Section, A. R. R. L.
Československí Amatérský Vysílač
Deutscher Amateur Sende- und-Empfangs
Dienst
Experimenterende Danske Radioamatører
Irish Radio Transmitters Society
日本アマチュア無線聯盟
Liga Colombiana de Radio Aficionados

Liga Mexicana de Radio Experimentadores
Nederlandsche Vereeniging voor Internationaal Radioamateurisme
Nederlandsch-Indische Vereeniging Voor Internationaal Radioamateurisme
New Zealand Association of Radio Transmitters
Norsk Radio Relæ Liga
Polski Związek Krotkofalowcow
Radio Society of Great Britain

Rede dos Emissores Portugueses
Reseau Belge
Reseau des Emetteurs Français
South African Radio Relay League
Suomen Radioamatööri- ja -kyltti r.y.
Sveriges Sandareamatörer
Unión de Radioemisores Españoles
Union Schweiz Kurzwellen Amateure
Wireless Institute of Australia

Conducted by Clinton B. DeSoto

The Amateur Regulations of the World: 1935

THE August, 1934, issue of *QST* contained a résumé of the amateur regulations of fourteen countries, members of the Union, all of those on which up-to-date, authoritative information was available. It was noted that the international amateur regulatory structure, as of that date, represented an almost incredible improvement over that existing just a few short years before. In every country of the world but two, where general radio regulations existed, amateurs were permitted. In most cases their privileges were quite liberal, in many instances being limited only by the provisions of the international treaty. An increase of several hundred per cent. in the territory allotted to amateurs in the several countries was manifest. All in all, this recountal displayed a thoroughly noteworthy advance in the situation of amateur radio internationally.

During the intervening twelve-month period since the publication of that report certain changes have been made in some of the national regulations, and some additions have likewise come to our attention. It is our purpose to present these modifications and additions at this time.

At the moment of writing, amateur radio, as we know it, is still not permitted in Colombia. For the past year or more Colombian amateurs in the L.C.R.A. have been struggling mightily to secure some relaxation of the military-inspired governmental disfavor in which amateur radio is there held. It had been anticipated that by the time this piece was written some new (and, we hope, favorable) developments would have arisen.

The anticipated word has not yet arrived, however, and for the moment it can only be noted that Colombian amateurs are licensed for 'phone



G6QP, WELL-KNOWN SCOTCH DX STATION, OWNED BY JOHN OXLEY, 282 EASTER ROAD, LEITH, SCOTLAND

work only, in the 6-mc. broadcasting band. Nonetheless, active amateur interest is strong, and the L.C.R.A. contains some 150 members.

In Denmark the following bands are available to amateurs: 1730-1830-1930 (spot frequencies), 3500-3600, 7010-7290, 14,020-14,380, 28,030-29,970, and 56,100-59,900 kc. Telephony is per-

mitted on all bands. A special form of beginner's operator's license is available for the 3.5-mc. band, with an 8-w.p.m. code requirement. The regular operator's license carries a stiffer examination, and an annual fee of Kr. 20 (\$4.40), which covers the station license, as well. The E.D.R. issues attests for the code examination; licenses are issued by the government. There is 100-watt input power limit; no specific restrictions exist concerning the type of emitted wave. Third-party traffic is not permitted. There are 142

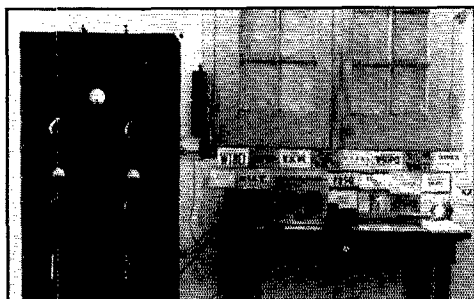

CM2AD, OWNED BY ADOLFO DOMINGUEZ HAVANA

Working principally on 7 mc., with 30 watts c.c. and the QST "simple receiver" (June, 1934), an imposing DX record has been run up.

licensed amateurs; the E.D.R. has 275 members. (In each case, these licensed amateur and membership figures are as of the date of reporting, usually early 1935.)

In France all Madrid bands are open to all types of amateur service. The operator's license, available upon examination, costs 50 francs (\$3.30). Pure d.c. and 'phone are the only types of emissions permitted. The nominal power limit is 100 watts. Third party traffic is not permitted. There are about 1000 licensed amateurs in France; the R.E.F.'s membership totals 1350.

The only change in Germany's regulations is an increase in the license fee from RM.2 to RM.3 (\$1.20). No telephony is licensed on any band. The 1.7- and 56-mc. bands are denied to amateurs. There are now 320 licensed stations; the D.A.S.D. has 3500 members.

Some liberalization in Great Britain's regulations has been achieved. The c.w. and telephony bands are now: 1720-1995, 3505-3730, 7005-7295, 14,005-14,395, 28,005-29,995 (television 30-32 mc.), and 56,005-59,995 kc. Naval reserve stations operate on 3740 kc. The 3.5-mc. band is available only on weekends during the summer months. The maximum input allowed is 1 kw.; the original license is for only 10 watts (£1, \$4.95) but R.S.G.B. is empowered to recommend increases of, after twelve months, 50 watts (£2, \$9.90) and then higher; there are only six stations in Great Britain permitted to use the maximum power. The only third party traffic permitted is that handled over Empire Link Stations. In No-

vember, 1934, there were 1451 full licenses, 932 for artificial (dummy) antenna systems; the R.S.G.B. has about 1200 members.

In the Irish Free State, c.w. and telephony bands are: 1740-1970, 7050-7250 and 14,060-14,340 kc. The 3.5-mc. band is usually available upon application after six months' experience. The 28-mc. and 56-mc. bands are available where special justification can be shown. The operator's license fee is 5/- (\$1.25); the initial station license fee £3 (\$14.85), annual renewal £2 (\$9.90). Ten watts is the power limit. No third-party traffic is permitted. There are 30 licensed amateur stations; the number would be greater, according to the I.R.T.S., were it not for the rigid licensing requirements and the stiff fees involved.

All Madrid bands excepting the 1.7-mc. band are permitted in the Netherlands for both c.w. and telephony, with 20-kc. buffer bands reserved on the edges of each band. The operator's examination fee is £5, - (\$3.40), the annual fee £10, - (\$6.80). The power limit is 50 watts; A2 emissions are banned. Third-party traffic is not permitted. With 270 licensed stations, the N.V.I.R. has a membership of 462.

The only change in the New Zealand regulations has been the opening up of the 14-mc. band to limited telephony. The number of licensed stations has increased to 805; the N.Z.A.R.T. has a membership of 710. Third-party traffic is permitted between amateurs only.

In Norway the licensed amateur figure has grown to 93; the N.R.R.L. has 347 members. Regulations remain unchanged.

The growth of amateur radio in Portugal has been to 190 licensed stations; the R.E.P. now has 400 members. The license fee is \$6.00.

In South Africa, the license fee has been raised to £ (\$4.95); all the Madrid bands remain open. Telephony is generally permitted; music transmission for testing purposes, however, is banned on the 7-mc. band and permitted only between 3,650 and 3,900 kc. on the 3.5-mc. band, the duration of each transmission being limited to three minutes.

All the Madrid bands are permitted in Sweden without any restrictions. There is no power limit, no specific regulation concerning the type of the emitted wave, and third-party traffic, while not authorized, is tolerated. The operator's license entrance fee is Kr. 40 (\$10.20) and annually Kr. 10 (\$2.55). There are 205 licensed stations; the S.S.A. has 190 members.

Conditions in general remain unchanged in Switzerland. The band 3700-3800 kc. is now available to club stations only. The U.S.K.A. is cooperating with the military authorities, and an army-amateur system is being planned. There are now 47 licensed stations in Switzerland, with a total U.S.K.A. membership of 190.

So, you see, again we progress. A considerable

(Continued on page 98)



OPERATING NEWS



Conducted by the Communications Department

F. E. Handy, Communications Manager

E. L. Battey, Asst. Communications Manager

Re Cairo—Do Your Part

HAVE you volunteered for some logging and reporting of commercial stations in connection with A.R.R.L.'s Cairo-Preparatory Survey? We again appeal to clubs, to all field organization men, to real hams everywhere, to members of the League and non-member amateurs as well to take an active part in this occupancy survey program. Get lined up to help your Cairo Committee at once by writing A.R.R.L. Hq. for the Committee's information and blanks. In writing specify whether you are interested in surveying the 4000-4500-kc. territory or the 6000-8000-kc. region, so the proper registered station list may be sent to aid you. More observers are needed, many more, and at once. This project is important, important to you if perchance you are interested in gathering practical facts which will be sifted carefully to provide your representatives with ammunition for use at Washington, Bucharest, and Cairo. Get or build coils to cover the ranges mentioned, if necessary, or use any all-wave receiver with a beat oscillator for your Cairo surveying. A large number of observers are needed for a considerable period of time. Your Committee is on the job with a program and definite plans, but it cannot do everything alone. The survey needs *you*, and you need the survey if you are interested at all in the subject of frequency allocations and the proposals to relieve QRM. *Do your part.* Drop a card to us asking for 4-mc. or 6-mc. log sheets to-day. You will receive them by return mail. Get busy!

Use 9-Point S Scale in Your R-S-T's

From the simple use of QSA, QRK, and QRZ in the early days to indicate three possible degrees of loudness, reporting requirements have progressively become more exacting, involving the use of numbers to indicate gradations of strength of signal, and to show other signal characteristics such as readability and tone. At a later period VY QSA and VY VY QSA were used, making it easy to express five steps of strength without numbers. The three QSA degrees were most used. In May 1925 *QST*, the R- plan was published, introducing numerical values and nine steps. The demands for greater accuracy, for more complete reports, and insistence on brevity in transmission at the same time, have been recurrent through the years.

Just one year ago, the R-S-T reporting system was introduced by W2BSR and presented as a *QST* paper. The plan has had a trial of one whole year, and what do we find?

Many letters attest the popularity of the system. Its use on *QSL* cards and on the air shows it has merits that are appreciated. Hams pronounce it the most snappy and efficient as well as the most intelligible way of reporting. On the all-important domestic band in which the larger percent of all our operating takes place, R-S-T has become practically universal. On the DX bands, 7 and 14 mc., R-S-T has also been heard, but to a lesser extent since the plan has not been published in some countries where progress moves more slowly. R-S-T has; however, in its one year, made far more friends, and been taken up more widely than any similar proposal of such general application, in a like time.

About the only real criticism in correspondence about R-S-T has been with relation to the number of points in the strength scale, which W2BSR now proposes (August *QST*) to revise from the scientifically determined five points to the psychologically desired nine. The response to this proposal has been as favorable as the initial acceptance of R-S-T. The idea, mentioned experimentally in the July O.R.S. Bulletin, brought much favorable comment. While no suggestion to use the 9-point idea until after discussion was made, surprisingly enough, more than half the RST's exchanged in July activities used the 9-point basis. Cards and letters removed all doubt as to whether the change was desired. A.R.R.L. is always guided by majority opinion, and responsive to the wishes of amateurs, we are pleased to announce the publication of a convenient, revised, R-S-T table on page 106, this issue. We suggest that effective at once all strength reports be given by the 9-point scale. Cut out the chart, and use the revised R-S-T system. In a matter of a very short time everybody will be on the 9-point basis, avoiding confusion. Just refer any ham to the new R-S-T list if there is any doubt about anyone having the right scale.

SHORTEN R-S-T REPORTS BY USING NUMBERS ONLY

With all the use given the R-S-T system we have wondered why the author's excellent suggestion to leave off the three-letter designation has not long since become standard practice. Yet, we seldom hear the three number reports without the prefix of R-S-T. Why not, we reason, have it understood, that *any* three number reports without a special designation (or followed by the X if you wish to report a crystal tone) refer to the R-S-T system?

For those that want to use longer or slower reporting methods conversation, letter designations before the numbers, and detailed description of transmission conditions and equipment will still be most satisfactory. QSA- and R- will always be clear, and R-S-T will always make a smooth approach to the giving of the report. It should be strictly understood that we have no quarrel with any other reporting system. Confidentially we are one of those old-fashioned people who always liked the rugged simplicity and integrity of QSA, or QRK, or QRZ (QRJ in modern parlance). For that matter, QSO's for communication purposes don't have to be burdened with reports on signals in many cases anyway. To the modern ham, or in any case where adjustment of equipment is at stake, or where we just *have* to get a comparison of the sound of our ether buster and Johnnie Ham's across town, the report that gives us the dope right to a gnat's eyelash is what we have to have.

Where speed and efficiency for movement of traffic or

fulfillment of DX work is at issue, however, and it is desired to exchange reporting information in the very minimum of time, causing least interference in the transmission, then it is appreciated by all of us, regardless of our personal slants, that the R-S-T system has its points. For maximum brevity mention of "Ur sigs" and "RST" can be left off. What else could 489X (leaving off this preliminary) be interpreted as, except a report by this up to date method?

—F. E. H.

Calendar, Fall Activities

For your convenience, here is a brief calendar or listing of different major operating activities that are scheduled for this fall:

(1) VK-ZL Contest with rest of the World, October 5th-6th, 12th-13th, 19th-20th, 26th-27th. Full detailed announcement elsewhere in this QST.

(2) A.R.R.L. ORS-OPS quarterly contests, for these field organization men and League officials only. One of the good get-togethers for the better operator. If you are not ORS or OPS, why not?

(3) For the Receiving Ham and a chance to compare Copying Ability and Proficiency for every amateur. The annual Navy Day Receiving Competition with dispatches addressed to you by NAA (4205 and 8410 kc.) and NPG (4385 and 8770 kc.) on October 28th. Drop a card for their schedules.

(4) VE/W Contact Contest, a chance to see which U. S. ham can work most Canadian stations and vice versa. A.R.R.L. Certificate awards in each Section decided by the Canadian Committee. Approved by the C.G.M. Don't Miss It! Dates? November 8th-10th.

(5) The Sixth Annual Sweepstakes, or National A.R.R.L. QSO Party. Operating Fun for Every One. This is one of the major events of the year for American hams. A.R.R.L. Certificate awards are made in every W and VE Section. Mark your calendar, dates of November 22nd-December 1st.

(6) R.S.G.B. 80-meter DX Testing and Two-Way Work, December 15th-18th and 19th-22nd. Arrangements by G5VL with full collaboration by A.R.R.L. Full opportunity for all European stations, and for W's and VE's. Polish up those 75-meter 'phones and 80-meter telegraph rigs now. Provision has been made for both types of work. See details in December QST.

(7) Last, but by no means least, A.R.R.L.'s Second Annual Copying Bee will be held Friday, December 27th. We hope to have approximately the same station line-up that transmitted for you last year, and again, a Silver Loving Cup Award will be made to the most proficient!

for all information received from W4AKI, regular contact being maintained. Numerous other amateur stations throughout Florida were also on the job cooperating with W4AKI and W4COT. It was only through W4AKI that the Red Cross could ascertain what food, medical supplies, etc., were needed in the area most seriously hit. The cooperation of numerous east coast 3.9-mc. operators in clearing the band of QRM helped materially. Notable among these were W2KR, W2BO and W3DQ. It is believed that W4QF/OA4AA was on the job with portable gear, sending news from the stricken keys, but details are not available. It is hoped that a complete story of amateur emergency work in the Florida storm will be ready for the November issue.

WSBHK, O.R.S. of Bath, N. Y., on battery power during the Western New York emergency, July 8th, 9th and 10th, kept hourly skeds and relayed much important traffic through other O.R.S. and A.A.R.S. Thanks are due W2EGF, W2BCX, W8DSS, W2AIZ, W2DXO and others for the fine cooperation and results on this occasion.

'Phone Activities Hit New High

Mid-summer operating of A.R.R.L. Official 'Phone Stations surpassed previous records of the number taking part, the number reporting, and the scores rolled up. J. H. Bricker, W8IJZ, of Mantua, Ohio, smashed all O.P.S. records, working 34 O.P.S. in 17 Sections in the brief space of a week-end party, making a new high of 3128 points right in mid-summer. There were 8 scores above 1000 and 20 over 300. More voice-operated stations are making application to S.C.M.'s for the appointment, and more O.P.S. are joining this national group right along, so that interest in quarterly activities is bound to keep looking up during all the coming season. A list of the newly appointed Official 'Phone Stations will appear in next QST. Leading O.P.S. scores in the summer party were as follows:

| Station | O.P.S. | QSOs | Sections | Heard | Score | Power | Section |
|---------|--------|------|----------|-------|-------|----------|---------|
| W8IJZ | 34 | 17 | 7 | 5128 | 100 | Ohio | |
| W8IKZ | 27 | 13 | 5 | 1885 | 100 | Mich. | |
| W9HSF | 35 | 11 | 2 | 1419 | 300 | Ind. | |
| W4AI | 21 | 10 | 18 | 1410 | 65 | No. Car. | |
| W8RG | 22 | 12 | 1 | 1344 | 120 | W. Pa. | |
| W4BYA | 20 | 9 | 17 | 1206 | 175 | No. Car. | |
| W8CSX | 19 | 9 | 13 | 1089 | 75 | Mich. | |
| W3CNY | 19 | 11 | 11 | 1045 | 720 | Va. | |
| W9LKI | 15 | 9 | 11 | 873 | 35 | Ind. | |
| W9KEF | 11 | 9 | 8 | 639 | 140 | Mo. | |
| W8CPJ | 13 | 9 | 13 | 611 | 25 | W. N. Y. | |
| W8DK | 12 | 8 | 5 | 528 | 300 | Mich. | |
| W8LLV | 13 | 6 | 11 | 522 | 31 | Ind. | |
| W9ITA | 10 | 7 | 6 | 434 | 150 | Ill. | |
| W8ICF | 9 | 5 | 17 | 395 | 300 | Ohio | |
| W3ALJ | 10 | 7 | 2 | 378 | 65 | Va. | |
| W8LUQ | 8 | 5 | 13 | 330 | 60 | W. N. Y. | |
| VE3JL | 10 | 6 | 2 | 324 | ... | Ont. | |
| W1EFC | 7 | 5 | 21 | 308 | 125 | Vt. | |
| W8BDD | 10 | 6 | .. | 300 | 140 | W. Va. | |

TO BECOME O.P.S.

A.R.R.L. operators who work 'phone mainly are invited to write S.C.M.'s about the Official 'Phone Station appointment. Blanks will be sent gladly on request. The O.P.S. appointment has more pleasant, enjoyable voice operating as its ideal. Two way voice work, rather than any imitation of broadcasting efforts is stressed. There is no such thing as a traffic requirement tied to this appointment. Members who hold O.P.S. appointment receive quarterly bulletins through which they exchange information and receive data from Headquarters. O.P.S. are asked to subscribe to a code of good voice operating ethics, and just as the prospective O.R.S. is examined as to his operating qualifications and traffic-knowledge by an A.R.R.L. Route Manager, each Section's Phone Activities Manager is charged with the responsibility of checking, by QSO or visits, the adjustment of applicant phone stations to see in advance of appointment that adequate means exist to tell when modulation over 100% exists, and that in normal operating it does not occur. Hams using any 'phone band, restricted or unrestricted bands, are eligible to hold this appointment, and when appointed, take part in the operating activities which assist in station testing as well as build fraternalism and strength to a growing national group.

Amateurs On the Job in Florida Hurricane

ALTHOUGH a complete report is not available as this issue goes to press, it is definitely known that radio amateurs performed gallantly in providing communication to storm-stricken Florida communities.

Early reports indicate that the bulk of amateur emergency work centered around Fred E. Bassett, Jr., W4AKI, Eustis, Fla. W4AKI provided the sole communication between Matecombe Key, the center of the Florida disaster, and the outside world. Normally located in Eustis, W4AKI took portable equipment to Matecombe, braving the severe storm to set up relief communication. He operated in the 3.9-mc. 'phone band. From 8 p.m. Monday, September 2nd, until 6 a.m. Wednesday, September 4th W4AKI, was on the job reporting the progress of the storm, handling all sorts of messages pertaining to relief supplies damage done, lives lost, etc. W4COT in Miami was the central clearing point

Gregg, W9IU, Second Time O.R.S. Party Winner; W4NC (W4RA) and W7AYO. Win Prizes in East and West Coast Areas!

In the July O.R.S. activities W9IU again came through and is the first second-time winner of the W9AUH-O.R.S. Trophy Cup. . . . It takes three wins to nail down the Cup as a permanent possession. Gregg's unprecedented score of 71,368 was based on 153 QSOs in 56 of A.R.R.L.'s Sections using 300 watts input power in the 30 hours of operation. This July 27/28 party included a premium for 7-mc. work which focussed attention on this band. Both "80" and "40" were regular beehives of activity, and summer conditions were favorable over most of the country.

The second high score, 50,061 points based on 152 O.R.S. QSOs in 41 Sections, was made by W4RA operating W4NC, who wins the millimeter award for the east coast area mentioned on page 56, July QST. In the Pacific area W7AYO bettered his April score, winning the meter for that area by rolling up 20,502 points from 63 QSOs in 34 different A.R.R.L. Sections. Congratulations to these prize winners.

The factor of 4 points for mid-west QSO's, 5 points for each QSO for stations in the eastern area, and 7 points for Pacific area stations met with general favor everywhere, and will be continued. In this summer party these factors did not fully perform the intended equalization of opportunity in the three areas, due to the special 9-point credit for all 7-mc. QSOs which was, of course, for this summer party only.

We are glad to present herewith full details on the work of the leading 25 operators. The operating ability it takes to make one's station a member of this group is indeed something to be proud of. In addition to the above, in the east coast area W1UE also made 102 QSOs, working 29 Sections for 18,618 points. The following Pacific area stations with scores over 2500 are also cited for outstanding work: W7NH (58 QSOs), 15, 750; W7BSU (45) 12,908; W6KFC (40) 10,932; W6CIS (37) 7866; W6LDJ (30) 6042; W7BXQ (27) 4698.

| Station | Q.R.S. | Sec- tions | Heard | Score | Power | Section |
|---------|--------|---------------|-------|--------|---------|-----------------|
| W9IU** | 153 | 56 | 85 | 71,368 | 300 | Indiana 30 hrs. |
| W4NC* | 152 | 41 | 106 | 50,061 | 300/500 | No. Car. 28 |
| W5NF | 136 | 43 | 125 | 46,182 | 250 | So. N. J. |
| W9KJY/9 | 121 | 44 | 33 | 41,228 | 250 | Ill. |
| WIMK | 138 | 43 | 38 | 39,259 | 800/950 | Conn. |
| WITS | 114 | 41 | 48 | 32,759 | 500 | Conn. |
| WIDMD | 102 | 38 | 71 | 31,844 | 200/300 | N. H. |
| W4BOU | 107 | 39 | 23 | 31,239 | 110 | Ala. |
| W8EUY | 96 | 41 | 19 | 30,750 | 450 | W. N. Y. |
| W3EOP | 107 | 31 | 188 | 30,380 | 400 | E. Pa. |
| W9DNU | 89 | 42 | 11 | 30,324 | 200 | Wis. |
| W8BHM | 83 | 38 | 11 | 28,804 | ... | No. Texas |
| W8RQM | 89 | 42 | 46 | 27,174 | 50 | Wis. |
| W2EYQ | 103 | 31 | 72 | 24,645 | 300 | N. Y. C. L. I. |
| W9KEH | 75 | 33 | 30 | 24,090 | 300 | Ill. |
| W6CPB | 90 | 35 | 25 | 23,975 | 135 | No. Texas |
| W2DXO | 96 | 31 | 65 | 23,126 | 400 | N. Y. C. L. I. |
| W8IAW | 96 | 30 | 49 | 22,590 | 100 | Ohio |
| W2AYJ | 93 | 33 | 61 | 22,539 | 400 | N. Y. C. L. I. |
| W4APU | 75 | 32 | 56 | 21,312 | 150 | Ala. |
| W4BRT | 37 | 3 | 36 | 21,210 | ... | No. Car. |
| W4OYA | 35 | 31 | 75 | 21,142 | 78 | No. Car. |
| W2CJX | 75 | 30 | 101 | 20,550 | ... | N. N. J. |
| W7AYO* | 63 | 34 | 56 | 20,502 | 500 | Wash. 0-300 ma. |
| W9RBV | 83 | 31 | 67 | 20,274 | 50 | Ky. |

** L. D. Gregg, W9IU, Cup Winner for April and July 1935.
* East and West Coast Area prize winners, C. R. Brewer, W4RA-W4NC, and Stan Belliveau, W7AYO.

ABOUT O.R.S. APPOINTMENT

League member stations that specialize in traffic handling are invited to become members of the Official Relay Station group, and to get in touch with Section Managers (see address of your S.C.M. on page 10). The quarterly activities for O.R.S. do not stress traffic handling, the first enjoyable duty of an O.R.S., but are designed to maintain and create high standards for snappy operating, that give a different form of

enjoyment from that that obtains in daily sked-keeping. Those amateurs who take a pride in the way messages are handled through their stations partake in traffic activity because this end of the game is their chief pride and joy . . . their thanks comes in the knowledge of a job well done. Only those with a sincere traffic interest should apply for O.R.S. appointment. Stations that sign "ORS" are widely known as the cream of operators, and the men behind the set stations take pride in forwarding a message offered to them at any time. If emergency requires it we know, that during

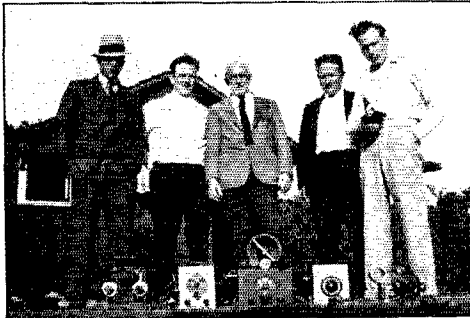

A FIELD DAY CREW AND THE GEAR USED. LEFT TO RIGHT: VE3WJ, VE3TM, L. H. TURNBULL VE3WX, VE3RO

O.R.S. doings or at any time, an O.R.S. may be depended on to QSP if asked. In fact several O.R.S. have been cited for exceptional work, performed unselfishly when called upon at just such a time! Hams depend on stations that sign "ORS" after their calls.

Hams Afloat

Considerable interest is shown in this Hams Afloat feature. We have some more dope this month on hams who are "sailing the blue." W7EBD and W7EKU are ops on the Coast Guard cutter *Onondaga*. W6BLZ reports that W6AKC and W6CUS are on a year's cruise on the yacht *Utaovondal*. W6AKC is radio operator. The party expects to go up the Amazon River and around the Horn. Listening will be done on the ham bands and 56-mc. gear is being taken along for shore expeditions. W1JI is pounding brass on the *Yomachicht*, WPAI, which runs between China and New York. W2GLJ and W1DND are pushing keys aboard the C.G. cutter *Ossipee*, NRCO, whose home port is Portland, Maine. Although he is not actually "afloat" (hi), the gang will be interested to know that W1EKH is opr. at the New Orleans Coast Guard traffic station. W2GVZ comes forward to tell of his past commercial operating experiences. In 1922 and 1923 he operated KFCX, WTII, WKAE, a fishing trawler, S.S. *Fisher*, and a couple of oil barges. So you can call him "Sparks" next time you work him! Behind the radio gear on the S.S. *Wildwood*, KORV, bound for the Pacific coast, will be found W4BRG, who, by the way, got some of his operating practice in the Sweepstakes Contest. W2CXD is now on the *Santa Catalina*, WMDY, which sails from Panama to Peru. W3BDH, who tells us about W2CXD, also reports W2ENZ running around the banana republics on the S.S. *Gatun*, HRBG. W3BDH himself is completing his first year on the M.S. *Santa Barbara*, WPBT, making plenty of stops between New York and Valparaiso, Chile. W5ACV is making a run on the S.S. *Conessa*. We received an interesting letter from W1DBU, who is operating on a whaling vessel, the S.S. *California*, KMWP. He says it's the floating factory ship of the California Whaling Co. and that they are anchored about a month at a time at San Clemente Island, Calif., following which they go in to San Pedro and discharge whale oil. W1DBU is making his home in San Pedro and hopes to sign W6 soon. It's interesting to note also that DBU's dad is skipper on the *California*. W8AEF, ex-9EMT,

has operated aboard KDUL, KFBX. He is now stationed at the Naval Air Station, San Diego, Calif., and is attached to Scouting Squadron Six-B, which goes aboard the U.S.S. *Omaha*, NISL, for maneuvers. W. H. Conant, ex-W1ABV, is operator on the Coast and Geodetic Survey ship *Gilbert*, working off the coast of Virginia charting depths of the water by the system known as "radio acoustic range." Anyone interested in that subject can get some good dope by writing Conant, care of the *M. V. Gilbert*, Box 303, Norfolk, Va. (Please enclose self-addressed stamped envelope.) We want to hear from all ship operators who are also amateurs. Shoot us the dope, OMI!

K6BAZ/K6XJI

W6CUH on August 14th worked K6XJI, K6BAZ operating, portable of the Dr. Dana Coman Scientific Expedition on Howland Island, 2000 miles SW of Hawaii. This expedition is making a three months' survey for an emergency landing field on the air route to Australia. K6BAZ mentioned that he thought that the party and some ten thousand birds must share the two-by-four island together. W9CVL also reports K6XJI's signals and says the fre-



THE QUEEN CITY AMATEUR RADIO CLUB (TORONTO) GANG OUT ON RECENT A.R.R.L. FIELD DAY

Left to right: VE3SG, Mrs. VE3WK, Mrs. VE3SG, VE3WU, VE3WK, VE3GR, VE3WT. They operated portable VE3SG/VE3LJ.

quency is about 14,300 kc. The expedition is sailing on the Schooner *Kinkajou*, WOFV. W6KBY worked K6XJI on August 20th.

While at a New York commercial station listening to the San Francisco circuit, T. R. McElroy, code expert, told the operator on duty he could copy it. The operator said, "Impossible, it's over 100 w.p.m." McElroy said, "Nix, that's only 90 per." An inquiry to San Francisco brought back the reply, "90 wpm!"

Announcement

The land line or text-only check has been adopted as official A.R.R.L. message checking practice, effective at once. The word count given in the check is simply that of the words, figures and letters in the body of a message.

Examples of word count, and detailed explanation of a few exceptions (how to count extra words in address and signature) are included elsewhere in this issue. The text-only check is just as easy as it sounds. It is suggested that in the interest of accuracy and good procedure every ham message should be checked. Try the text checking on the next message you handle. Use the land line check, which is now standard A.R.R.L. practice!

Navy Day Receiving Competition

October 28th

Washington, NAA. On 4205 and 8410 kcs.
San Francisco, NPG. 4385 and 8770 kcs.

All amateurs are invited to listen and copy the telegraphic transmissions addressed to radio amateurs from NAA and NPG on Navy Day, October 28th. Forward your copies for grading to the A.R.R.L. Communications Department, West Hartford, Conn. Letters signed by the Secretary of the Navy are customarily awarded the amateurs submitting the best copies, and a Navy Day Honor Roll appears in *QST*.

BRIEF

W1CMX, Fall River, Mass., was working D4BIU on 14 mc. BIU wanted some dope from Hartford. CMX cranked up his 56-mc. receiver and heard W1GDJ working W1HBD (West Hartford). He called GDJ and gave him the info for Hartford, while D4BIU waited. The answer came back and was relayed to Germany. At the time of evening this took place, the 90-mile link between Hartford and Fall River was working excellently while all other lower frequency bands were "skipping over" for that distance. Don't overlook the possibilities of 56 mc. for short-haul traffic work, you message handlers!

DX Notes

THIS month Don Mix, W1TS, gives his observations of the best times to QSO various DX points on 14 mc.: Best time for J's—9:00 to 10:30 a.m. They should come through earlier, but they don't seem to get on the air until about 9:00. W1TS heard J's 75% of all days during August. PK and VS are heard irregularly from 8:00 to 9:30 a.m. European signals are coming through from 7:00 to 11:00 a.m., but best time is 8:30 to 6:30 p.m. South America is heard irregularly from 7:00 to 8:00 a.m. Best time 5:00 to 8:00 p.m. Central Americans are good from 7:00 to 9:00 a.m. and 5:00 to 10:00 p.m. Australia and New Zealand may be worked on 14 mc. from 7:00 to 9:00 a.m. FB8C, Madagascar, is heard regularly from 8:00 to 9:30 a.m. KA's are heard quite regularly from 8:00 to 9:30 a.m. W1TS has been handling traffic direct with KA1CM and KAILB! These approximate frequencies will be helpful in spotting 'em: KA1CM 14,225 kc.; KAILB 14,285; J2LB 14,280; J5CE 14,300; J2KJ 14,160; J2LU 14,325; VS8AQ 14,270; J2LK 14,810; PK3ST 14,290.

Europeans are still quite plentiful on 14 mc. on the west coast, and are breaking through any hour from 6:00 a.m. to midnight. W6HXP gives some frequencies of 14-mc. 'phones heard: CE1BC 14,154 kc.; PY1AK, from about 4 to 6 p.m., 14,370; LU7AZ, about the same time, 14,300. Those W6's who get up around 6 a.m. should look for VS1AJ 14,330 kc. Other foreign stations coming in exceptionally well on the west coast: TI2RC 14,104; HI7G 14,104; TI2AV 14,142; TI2EA 14,060; HP1A 14,320; VK3MR 14,290; VK2EP 14,200; G5NI 14,104; EA4AO 14,090. For a new country keep an ear open for VR2AK, 14,325 kc., Union Island, in the Ellice and Gilbert Islands group. We are indebted to W6HXU and his DX column in "73" for this dope on good DX heard on the west coast.

W8MQX reports a QSO with XL2, the Schooner *Humay*, off the coast of Newfoundland, about 7000 kc., r.a.c. note. W5BNO, Grapevine, Texas, was QSO VS1AJ, Malay Peninsula, at 7:55 a.m. CST, August 13th. W5BNO reports VS1AJ coming through consistently during the morning DX periods. Frequency of VS1AJ is near the middle of the high-frequency side of 14 mc. W5BNO is interested to know if any other W5 has QSO'd VS1AJ. W8HGA worked VS1BO at 9:00 a.m., June 1st.

Briefs

Robert J. Gleason of Fairbanks, Alaska, the radio operator who flew south with the bodies of Post and Rogers, is a member of the A.R.R.L. and is known in ham circles as K7KD.

Vermont 1.75-mc. 'phone hams are getting long winded—W1CGV and W1GQJ held a duplex QSO on August 26th lasting from 9:30 a.m. to noon.

Woodpeckers take great delight in working on W6SHV's 50-foot antenna mast. Determined to end the nuisance, SHV got out his trusty rifle, only to hit a guy rope instead of a woodpecker!

Amateurs looking for a good traffic route to the Philippine Islands should not pass up the good service offered by W3QP, W6TM and KAIHR, whose daily schedules connect the east coast, west coast and P. I.

W2ING plans to run a column of articles gathered from high schools all over the country in his school paper. He desires to submit these articles in radiogram form and to get them over the air from amateurs who attend the various high schools. All hams who attend high school and who would be interested in cooperating with W2ING in this should get in touch with him either by radio (ING is on 7230-kc.) or by mail so that regular schedules may be arranged. Address Mortimer Rogoff, 1495 E. 24th St., Brooklyn, N. Y.

The 210 DX Club

Of interest to operators of low- and medium-powered stations is the announcement of a nationwide club for DX enthusiasts, to be known as "The 210 DX Club." Organized for amateurs who work their DX with moderate power, the club has the following requirements: Applicants must (1) not use over 150 watts to the final stage of their transmitters, (2) must hold W.A.C. appointments, (3) must have worked at least fifty countries, and (4) must use tubes of the nature of a type '10 or of that power rating. The officers are selected in accordance to the number of countries worked. W6GAL, having worked 64 countries, a greater number than any present member, is the president. Anyone interested in joining this DX Club may get further information from the secretary, Win Peebles, W8GQB, 15060 Greenview Blvd., Detroit, Michigan.

Central Massachusetts Radio Association

Approximately 150 hams and hamesses gathered in Worcester, Mass., on July 21st to participate in a 56-mc. hidden transmitter hunt held under the auspices of the Central Mass. Radio Assn. The object was to determine the New England transmitter hunt champion. W1KK of Bondsville, Mass., went home with the silver plaque offered the winner! Runners-up were W1ECM, W1IIG and W1EFQ. The hidden stations were operated by W1ZJ and W1DA. A program of sports contests was conducted under the direction of W1AQM for those not prepared to enter the Championship Hunt.

The Central Massachusetts Radio Association will celebrate its first anniversary on October 16th and extends a cordial invitation to all amateurs to be present. A lively program is promised. The time: 7:30 p.m. The place: The club quarters, 442 Main St., Worcester.

Andes-Amazon Expedition

John Ohman, W2DPQ, is radio operator with the 1935-1936 Andes-Amazon Expedition, which left New York August 10th to penetrate one of the most isolated and little

BRASS POUNDERS' LEAGUE

(July 16th-August 15th)

| Call | Orig. | Del. | Rel. | Total |
|-------|-------|------|------|-------|
| W6HDV | 205 | 140 | 780 | 1125 |
| W6TM | 193 | 248 | 449 | 850 |
| W6JBI | 13 | 11 | 784 | 808 |
| W7AYO | 52 | 52 | 644 | 748 |
| W7NH | 16 | 20 | 697 | 733 |
| W2BCX | 43 | 158 | 487 | 688 |
| W6INH | 23 | 36 | 600 | 659 |
| W6JII | 10 | 1 | 584 | 595 |
| W7BXQ | 15 | 3 | 557 | 575 |
| W7CQI | 53 | 397 | 68 | 518 |

MORE-THAN-ONE-OPERATOR STATIONS

| | | | | |
|--------|-----|-----|-----|------|
| KAIHR | 464 | 446 | 740 | 1650 |
| W6ZG | 612 | 418 | 198 | 1228 |
| W6ZG** | 206 | 310 | 98 | 614 |
| W50W | 114 | 132 | 296 | 542 |

These stations "make" the B.P.L. with totals of 500 or over. Many "rate" extra credit for one hundred or more deliveries. The following one-operator stations make the B.P.L. for delivering 100 or more messages: the number of deliveries is as follows: Deliveries count!

| | | |
|-----------|-----------|---------------|
| W6CHD 303 | W6GHG 117 | W3EOP 106 |
| W6HPG 207 | W2GOX 117 | VE5DN 101 |
| W2CHK 158 | W6RQE 113 | More-than-one |
| VE5CV 150 | VE5KC 111 | W6EK** 299 |
| W9LEZ 127 | W3BWT 107 | VE5DB 109 |
| | W9MUY 107 | |

A.A.R.S. STATIONS

| Call | Orig. | Del. | Rel. | Total |
|--------------|-------|------|------|-------|
| WLMI (W6GXM) | 48 | 169 | 864 | 1081 |
| WLNF (W2BCX) | 29 | 129 | 534 | 692 |

MORE-THAN-ONE-OPERATOR STATIONS

| | | | | |
|---------------|-----|-----|-----|-----|
| WLV (W6ZG) | 381 | 293 | 108 | 782 |
| WLV (W6ZG)** | 112 | 208 | 74 | 394 |
| WLVK (W6EK)** | 24 | 161 | 12 | 197 |

A total of 500 or more, or just 100 or more deliveries will put you in line for a place in the B.P.L.

* B.P.L. rating on deliveries.

** June-July

known regions of South America. In this region dwells a tribe called the Ssabela Indians. Practically nothing is known of these people, and there is no record of any white man having entered their country. The purpose of this expedition is to endeavor to establish contact with the Ssabelas, study them, and bring back such knowledge and specimens as can be obtained. Arriving in Ecuador August 27th, plans call for starting in mid-September for the point where a base will be established. This trip to the base position will take about three weeks, so it is expected to be early October before operations will definitely start. The expedition will be out from six months to one year. The territory to be traversed is so wild and uninhabited it is expected that radio will prove a valuable asset to the party. Contact with HC1FG (on 7 mc.) was planned to start upon arrival in Ecuador. Further developments will be reported later.

Code Speed Championship Again at Stake

As this issue goes to press we learn of a week's hamfest and short-wave exposition to be held in conjunction with the Brockton (Mass.) Fair, Sept. 8th-14th, through the effort and initiative of Mark L. MacAdam, W1ZK. A week full of various contests, demonstrations, exhibitions, talks, movies, etc., will wind up Saturday, the 14th, with the world's best known code-copying artists assembled to compete in a new World's Championship Code Speed Contest. Among those scheduled to compete are Joe Chapin (present champion) and Benny Seuter of Press Wireless, C. W. Donnelly of Mackay Radio, and Ted McElroy, 1922-23 world champion. The speed will start at 50 w.p.m. and will be increased at 2 w.p.m. jumps until all but the winner are eliminated. The text to be transmitted will contain punctuation, capital letters, etc. Judges will be Lloyd Greene, W1ACF, of the *Boston Globe*, Charles C. Kolster, Radio Inspector, Boston, and Joe Toye of the *Boston Traveler*. The material to be transmitted will be selected and the

tape to be used perforated under the personal supervision of Mr. Kolster. The automatic transmitter to be used in this Contest was constructed by Frank Borsody, W2AYN, who will be remembered as one of the operators transmitting text in the A.R.R.L.'s 1934 Copying Bee. The results of this World's Championship Code Contest will appear in November *QST*. It is sure to be one of the stiffest competitions ever held.

P. I. Amateurs Coöperate With Weather Bureau

Each year during the typhoon season amateurs in the Philippine Islands coöperate with the Weather Bureau in furnishing information on conditions in outlying districts. Complete information is needed to plot the course of storms and send correct warnings to ships and localities where the center will pass. KA1TS, Manila, has been appointed as the Central Station to receive reports and 'phone them to the office of the Weather Bureau. The information required is wind direction, wind velocity, barometer readings and condition of weather.

Briefs

Connecticut Tercentenary Celebration

An amateur radio station will be on exhibition at the East Hartford Tercentenary Celebration, October 6th-13th. In addition to the station itself much historical equipment, photos, QSL's, etc., will be exhibited. The committee in charge expects to use the call W1CSC/1 and to have an operator on duty from 2:00 to 9:00 p.m. E.S.T., each day of the celebration. The station will be active on 1.75, 3.5, 7, 14 and 56 mcs. Considerable traffic is expected, and the coöperation of all amateurs in clearing same from W1CSC/1 will help make this exhibition of amateur radio a complete success.



Mrs. Carrie Jones, W9ILH, R.M. and O.R.S., well known traffic handler, Illinois operator on A.R.R.L. trunk line "K"; M. D. Jones, W9ICN, O.R.S., Illinois operator on trunk line "L". Photo by W8JTT during his visit at their shack.

The A.R.R.L. Traffic Trunk Lines will reopen on October 1st. Each of the thirteen lines will operate on a spot frequency this season, 100% crystal-controlled.

56 Mc.

A new Western 56-mc. DX record was established when W6ITH and W6AM made contact from Mt. Whitney (W6AM) to Mt. Diablo (W6ITH), an airline distance of 216 miles!

At 9:50 p.m., August 10th, W1ZJ, mobile on 56 mc., hooked W2MO, portable just outside Paterson, N. J. W2MO was on a hill around 500 feet high; W1ZJ was in a moving car on a small hill, about 250 feet high, in Franklin, Mass. This is believed to be some sort of a record for mobile work.

Communication at the Third Annual South Shrewsbury (N. J.) Ice and Yacht Club Regatta, held August 4th, was greatly facilitated by the use of a public address system and 56-mc. transceivers under the direction of W2HWX, Secretary of the Yacht Club. Transceivers supplied communi-

cation between the judges' stand and the administration building ashore. A transceiver placed in the committee boat, which followed the sailing craft around the course, reported the positions of the leading boats. These reports were picked up at the judges' stand and the information announced over the public address system. The amateurs participating in this work were W2HWX, W2FQK, W2IMI, W2IKL and W2GUM.

Gordon Barbour, operator of CP1GB, the Bol-Inca Expedition to Bolivia, was a recent visitor to HQ's. He will remain in the States for some time and may be addressed at 389 Broadway, Paterson, N. J.

Wanted—Stations to Send Code Practice

The A.R.R.L.'s program of code practice on the 1715-kc. band is being revised for the active radio season. Many new stations are needed to carry on this work. Stations engaged in the work last season are being requested to furnish new schedules for publication in *QST*. This 1715-kc. code practice is one of the most worthwhile of amateur endeavors. It is an inestimable help to the beginner in getting a strong foothold. Any amateur working in the 1715-kc. band wishing to volunteer regular schedules of code practice is invited to drop a card to A.R.R.L. Headquarters. Please state the days and hours you would like to send code lessons, and list your exact frequency. The schedules of all volunteers will appear in *QST* and will also be mailed to those interested. Helpful hints relative to the sending of code practice are furnished all volunteers by A.R.R.L.

WSCEO says, "The Cairo Committee has decided to conduct a survey on the 80-meter band in addition to one on the 40-meter band. I wonder how many of the most vociferous of the critics of A.R.R.L. will be found regularly on the job surveying one or the other of these bands, doing a bit of real constructive work along the line that they have been talking about. Whenever your most virilious club member gets up in meeting and advocates a drastic overhauling of the League organization, you can now ascertain in a most simple manner just how much he is willing to do for amateur radio. Just ask him to show his 'survey' schedule. If these boys are sincere in their belief that not enough has been done in the past to help us to obtain a greater frequency range, they now have an excellent opportunity to prove their sincerity by their own work."

—The A.T.A. News

"CQ TFC" is the general call used in the GENERAL TRAFFIC PERIOD—6:30-8:00 p.m. (local time). Use this period to move your traffic through reliable stations. Operators who sign "ORS," "TLS," "RM" or "SCM" after their call are sure to be "reliables." The very use of "CQ TFC" by any operator indicates an interest in reliable traffic work. Coöperate with the stations using the TRAFFIC HOUR!

O.R.S., O.P.S. Don't forget. Next period of quarterly activities is October 26th/27th. Full details will be included in the A.R.R.L. Bulletin mailed you just before those dates.

W9TTY handled a message with W9RIU, Isle Royale, Mich., that caused the U. S. Coast Guard to take an M.D. out to meet a Conservation Dept. boat in mid-lake—the Conservation boat was carrying two men who had been hurt in a plane crash. The men got to the hospital OK. FB!

W1OXFP

W2GVZ, O.R.S., Ridgewood, N. J., worked the Schooner *Morrissey*, W1OXFP, from 9:00 to 10:00 p.m. EDST, August 3rd, on 14,290 kc. He took a 100-word message for the

Navy Department, Washington. Location of the *Morrissey* was Baffin Bay. W2GVZ has arranged a nightly schedule with W10XFP. W2GOX has a daily schedule with the schooner, and invites traffic.

248th Coast Artillery Net

The 248th Coast Artillery Battalion (Harbor Defense), Washington National Guard, has established a communications net for the handling of radiograms within the battalion. This net is composed of amateur radio operators, and includes W7EZZD, Battalion HQs, Olympia; W7YS, Lacey; W7ECA, Lacey; W7CIA, Olympia; W7DHF, Olympia; W7APU, Snohomish; W7SIJ, Aberdeen. These stations rendered commendable service during the 1935 encampment of the 248th Bn. at Fort Worden, June 8th to 19th. Daily schedules were maintained between the Fort and Aberdeen, Snohomish, Olympia and Lacey. A total of 608 messages were handled and 6146 words of press transmitted. W7APT, Seattle, also co-operated. Frequencies used for work with the camp were 3.5-mc. c.w., 3.9- and 1.75-mc. 'phone. Regular communication between the Olympia headquarters and the various units is made possible by the amateur radio net. Such service has proven a real convenience to the command of the Battalion as well as the families of the personnel.

Mr. Burton's article wins the C.D. article contest prize for this month. Each month we print the most interesting and valuable article submitted in connection with the article-contest. Contributions may be on any phase of amateur operating or communication activity which adds constructively to amateur organization work. Prize winners may select a bound Handbook, six logs, six message files, six pads blanks, or equivalent credit toward a combination of A.R.R.L. supplies. Let's have your article. Mark it "for the C.D. contest," please.

—F. E. H.

A Test of CQ's

By A. J. Burton, W5BDX *

JUST like everyone else in this ham game, I have always been interested in obtaining the most number of QSO's with the least amount of calling. I recently decided I would really find out about this CQ business for myself.

The statement has been made that "Everybody on your frequency hears your first CQ and those not on you never will hear you." That sounds very broad. If so why even call CQ 3x3?

Let me pause here and say that I have never called CQ more than 3x3 in the short time I have been on the air—just about a year—and that the percentage of successful CQ's has been about 80%. Also the transmitter at W5BDX is not a high-powered one, but an MOPA with a 46 in the output amplifier with 13.6 watts input.

To make the test interesting I decided to call 100 CQ's, varying them among CQ3 x 1—3 x 2—3 x 3. The first call was sent, just CQ CQ CQ DE W5BDX W5BDX W5BDX AR, nothing more. Say, that sure seemed like a waste of energy, but I turned on the receiver and started tuning, and there was a VE calling W5BDX. All the calls were not as successful as that one but, to sum them all up, the following was the result of those 100 CQ's:

| CQ's | 3 x 1 | 3 x 2 | 3 x 3 |
|------------|-----------|------------|------------|
| Answered | 6 (54.6%) | 28 (63.7%) | 35 (77.8%) |
| Unanswered | 5 | 16 | 10 |
| | 11 | 44 | 45 |

The reason why there are so many more 3 x 2 and 3 x 3 is that I would forget to stop on the first one. Hi! During this test all districts have been worked many times, and the short CQ's seemed to bring in the greatest DX.

Notice how the percentage of replies varies with the length of the call. You can have 54.6%, or 63.7%, or 77.8%

* 760 E. Walnut St., Enid, Okla.

assurance of a reply, for the given set up and operating conditions, depending on whether your call includes one, two, or three repetitions of the series.

Of course it would be wrong to increase the length of CQ's much nearer to a point where assurance of replies reaches the 100% mark. After a three times three CQ sent at ordinary rates of speed, one has more than "reasonable" assurance of a reply, better than 3 to 1 odds of success. If CQ's are lengthened unduly, the point is quickly reached where the number of listeners turning the dial to a more snappy operator equals the number of "new" listeners picked up, and the chances of getting an answer are not increased further. The "three times three" CQ justified itself in our test.

Another interesting thing was that at the end of twenty of our test QSO's the QRZ? was called, with the following results—13 calls answered and 7 unanswered, a 65% success-record that indicates the system justified for the efficient operator.

From the above it may be easily seen that anyone who calls CQ more than three times three is just wasting the time and energy of himself and the other fellow.

ELECTION NOTICES

To all A.R.R.L. Members residing in the Sections listed below: (The list gives the Sections, closing date for receipt of nominating petitions for Section Manager, the name of the present incumbent and the date of expiration of his term of office.) This notice supersedes previous notices.

In cases where no valid nominating petitions have been received from A.R.R.L. members residing in the different Sections in response to our previous notices, the closing dates for receipt of nominating petitions are set ahead to the dates given herewith. In the absence of nominating petitions from Members of a Section, the incumbent continues to hold his official position and carry on the work of the Section subject, of course, to the filing of proper nominating petitions and the holding of an election by ballot or as may be necessary. Petitions must be in Hartford on or before noon of the dates specified.

Due to a resignation in the Wisconsin Section nominating petitions are hereby solicited for the office of Section Communications Manager in this section, and the closing date for receipt of nominations at A.R.R.L. Headquarters is herewith specified as noon, October 15, 1935.

| Section | Closing Date | Present SCM | Present Term of Office Ends |
|-------------------|---------------|----------------------|-----------------------------|
| Saskatchewan* | Oct. 15, 1935 | Wilfred Skafte | June 15, 1934 |
| Vermont | Oct. 15, 1935 | Harry Page | Oct. 20, 1935 |
| San Diego | Oct. 15, 1935 | Harry A. Ambler | Oct. 20, 1935 |
| Wisconsin | Oct. 15, 1935 | Harold H. Kurth | |
| W. New York | Nov. 1, 1935 | Don Farrell | Nov. 4, 1935 |
| British Columbia* | Nov. 15, 1935 | R. K. Town | Nov. 20, 1935 |
| Connecticut | Nov. 20, 1935 | Frederick Ellis, Jr. | Dec. 4, 1935 |
| Oklahoma | Feb. 1, 1936 | Carter L. Simpson | Feb. 15, 1936 |
| Alberta* | Feb. 10, 1936 | J. Smalley, Jr. | Feb. 18, 1936 |
| Montana | Feb. 10, 1936 | O. W. Viers | Feb. 18, 1936 |

* In Canadian Sections nominating petitions for Section Managers must be addressed to Canadian General Manager, Alex Reid, 169 Logan Ave., St. Lambert, Quebec. To be valid such petitions must be filed with him on or before the closing dates named.

1. You are hereby notified that an election for an A.R.R.L. Section Communications Manager for the next two year term of office is about to be held in each of these Sections in accordance with the provisions of By-Laws 5, 6, 7, and 8.

2. The elections will take place in the different Sections immediately after the closing date for receipt of nominating petitions as given opposite the different Sections. The Ballots mailed from Headquarters will list the names of all eligible candidates nominated for the position by A.R.R.L. members residing in the Sections concerned. Ballots will be mailed to members as of the closing dates specified above, for receipt of nominating petitions.

3. Nominating petitions from the Sections named are hereby solicited. Five or more A.R.R.L. members residing in any Section have the privilege of nominating any member of the League as candidate for Section Manager. The following form for nomination is suggested:

Communications Manager, A.R.R.L.
38 La Salle Road, West Hartford, Conn.

We, the undersigned members of the A.R.R.L. residing in the.....Section of the.....Division hereby nominate.....as candidate for Section Communications Manager for this Section for the next two-year term of office.

(Five or more signatures of A.R.R.L. members are required.)

The candidates and five or more signers must be League members in good standing or the petition will be thrown out as invalid. The complete name, address, and station call of the candidate should be included. All such petitions must be filed at the headquarters office of the League in West Hartford, Conn., by noon of the closing date given for receipt of nominating petitions. There is no limit to the number of petitions that may be filed, but no member shall sign more than one such petition.

4. Members are urged to take initiative immediately, filing petitions for the officials for each Section listed above. This is your opportunity to put the man of your choice in office to carry on the work of the organization in your Section.

—F. E. Handy, Communications Manager

ELECTION RESULTS

Valid petitions nominating a single candidate as Section Manager were filed in a number of Sections, as provided in our Constitution and By-Laws, electing the following officials, the term of office starting on the date given.

| | | |
|----------------------|-------------------------|----------------|
| Eastern Pennsylvania | James M. Bruning, W3EZ | Aug. 7, 1935 |
| Washington | Nillo E. Koski, W7LD | Aug. 15, 1935 |
| Alaska | Richard J. Fox, K7PG | Sept. 3, 1935 |
| San Joaquin Valley | Vernon C. Edgar, W6CF | Sept. 3, 1935 |
| E. Massachusetts | Albert N. Giddis, W1ABG | Sept. 16, 1935 |
| Eastern New York | Robert E. Haight, W2LU | Sept. 16, 1935 |

In the Arizona Section of the Pacific Division, Mr. C. C. Day, W6LVG, and Mr. Ernesto Mendoza, W6BJF-QC, were nominated. Mr. Day received 23 votes and Mr. Mendoza received 21 votes. Mr. Day's term of office began July 24, 1935.

National Highlights

IF ADVANCE plans and promises are any criterion, we're headed for an extremely active winter of operating. All amateurs are invited to report any unusual and interesting communication work for these columns.

W2BGO was among those handling New York state flood traffic. The 100-foot mast of the Bristol (Conn.) Radio Club was struck by lightning, plenty of damage resulting. W3EVA is planning a 56-mc. traffic net between Laurel, Md., Baltimore, Annapolis and D. C. The fourth West Virginian to qualify for W. A. C. is W8HGA, who recently worked VS1BO.

A Roanoke Division contest has been lined up by Virginia's Chief R.M., W3AAJ, and S.C.M. W3BRY. In three years of operation W9KEH has had 4737 QSO's, an average of better than 4 QSO's every day! Thirty-five registered at Hope Community Lake, North Dakota, for the first annual picnic of District One, A.A.R.S. Plans are under way in the Dakota Division to put all S.C.M.'s and R.M.'s on a spot frequency.

The Third Annual Field Day of the South Jersey Radio Association was held August 18th; the main features were a 56-mc. hidden transmitter hunt and a feed and "bullfest." Prizes were won by W3EUY, W3AN, W3EWF and W3AZG. R.M. W1CJD announces the inauguration of a new system of operation for the Connecticut Net this season; two general working periods will be used, one in the morning, one in the evening. The Albany (N. Y.) Club recently held a 56-mc. Field Day in the Helderberg Mts.

The Watchung Hills Amateur Radio Association, with headquarters at Bound Brook, N. J., has received a call for its station, W3FRO. This club was instrumental last spring in conducting a 56-mc. two-way radiophone demonstration for the Bound Brook and Highland Park Police Departments. Officers are W3EWW, president; W2GLH, vice-president; W3ECG, secretary; W3AAE, treasurer. Amateurs in North Carolina, West Virginia and Virginia are looking forward to the annual Roanoke Division Convention to be held in Charlotte, N. C. A Northern New Jersey O.R.S. get-together is scheduled for October 4th. Plans for section activities for the '35-'36 season will be discussed.

W7DBY, Bacona, Oregon, keeps regular schedules with K7LW and K7EGC, and gives good service on Alaskan Traffic. The Brasspounder, formerly Washington's section paper, now covers the entire Northwestern Division. W7LD and the S.C.M.'s of all N.W. sections comprise the editorial staff. The annual Oregon Field Day, August 18th, found many hams on the summit of Mt. Hood with 56-mc. gear. W5DNE, Sherman, Texas, will have a station at the Red River Valley Fair, Sept. 30th-Oct. 5th.

An excellent route from the Philippines to the east coast runs K1LHR-W6TMM-W3QP. Connections to Hawaii are also available via W6HDV-K6MEG. The Southeastern Division Convention at Miami in October is one of the principal topics for discussion in the south. The Monroe (Ga.) Radio Club held a hamfest August 18th with 55 present. A barbecue was a main attraction, as well as talks by W4BBV, Asst. S.C.M. for Georgia, and W4BTI. Each week day at noon the following participate in a 'phone round

table, some on 1.75, some on 3.9 mcs.: W9KQX, W9RGK, W7BCL, W7CEO, W9RGX and W9PWU.

The Louisiana State Convention, August 24th-25th, was a real humdinger with every one present enjoying himself to the fullest. The New Orleans Radio Club was praised by all for the fine gathering. R.M. W8DVC is working on plans for a big Michigan Network, to function on 1.75 and 3.5 mcs. W8BRS is organizing a Chair Warmers' Club trunk line. The Detroit Amateur Radio Association promises a big time to all who attend its hamfest, October 13th. W8BAH handled some traffic for Alaska concerning the Rogers-Post plane crash. A picnic held by the Milwaukee Radio Amateurs' Club was attended by about fifty-five families.

The Chattanooga (Tenn.) Club was entertained at the home of W4LU for its August meeting. W1BEF, Lowell, Mass., spent one Sunday afternoon on Mt. Wachusett working portable on 56 mc.—result, 42 stations worked! W1XR, well-known Mt. Washington summit station, was struck during a recent electrical storm. A Vermont QSO Party has been scheduled for Sunday p.m., September 29th. The Bell, Calif., Club is the most consistent winner of the Los Angeles section traffic banner, holding it nearly every month.

W6ITH and W6AM established a new western 56-mc. DX record when they were 280 from Mt. Whitney (W6AM) to Mt. Diablo (W6ITH), an airline distance of 216 miles! W6GHD, Walnut Creek Calif., during the past month delivered 303 messages by air mail—that's service! The San Francisco 56-mc. gang has gone in for mobile work in a big way; it helps to solve the YL problem, since the YL can come right along for the ride while you work the rig. Hi. W2HNP made 1660 QSO's his first year on the air; he kept moving right along! The annual hamfest at Jenny Lake, Grand Teton National Park, was well attended and a complete success. W5MN handles weather for the Meteorological office at Fort Sam Houston, Texas. W9AIR reports that the Yacht *Mispah*, sailing the Great Lakes, works hams when time permits; frequency used most often is 4145 kc.

STATION ACTIVITIES

WEST GULF DIVISION

NORTHERN TEXAS—SCM, Richard M. Cobb, W5BII —DXA's crystal went west after an hour at the O.R.S. party; he is now running 150 to 200 watts input to new R.C.A. 838. EAV is papa of a 7½-lb. boy. AXK is active. AZB will be on for A.A.R.S. season. BEY and EES are on using buffers. CPB's new power is working fine for DX and he made 37,000 points at the O.R.S. party. EEW reports 9RYD/WLMF is working in Dallas now and will have his kw. on there soon. COK was in Chicago for two weeks. CHO is active. DAF is thinking seriously of getting on. EHM scored 28,806 at O.R.S. party. EEF has new crystal rig on now and worked first VK using 35 watts input. BKH is on for U.S.N.R. drills. DNE has installed pair of 825's in final with input of 150 watts; he will have transmitter at the Red River Valley Fair, Sept. 30th-Oct. 5th. CPT increased power to 10 watts on 14 mc.; he now has Class A ticket. QU worked ship from Denmark and several VK's with new c.c. rig using an '03A in final. BII did a little portable work at Camp Hulen during the T.N.G. Camp. BXA is building crystal rig using R.C.A. 802 final to work on 3610 kc. EWB was QSO with BII's portable. EJJ is going to A. & M. College. BCW is on 3.5 mc. each Sunday for U.S.N.R. drills. FRQ is doing some FB work using 10½ watts input to a pair of '45's on 7 mc. AID was on the air at Camp Hulen using a pair of '10's in portable transmitter. ATG is papa of new baby boy. At Camp Hulen the S.C.M. met a fine bunch of hams including CAV, CCD, AID, FER, IA, CLI, FHC, BGL, BYM, AW and DRO. ETK wishes to conduct tests with amateurs in and around Waco; he is using push-pull oscillator and will be found on the air Sunday afternoons.

Traffic: W5DXA 145 CPB 53 EEW 47 COK 40 EHM 34 EEF 26 BKH 22 DNE 16 CPT 13 QU 9 BII 5 BXA 2

OKLAHOMA—SCM, Carter L. Simpson, W5CEZ—CEZ grinds crystals for A.A.R.S. State Net frequency. CJZ

kept schedules with CVA at Ft. Sill during O.N.G. Camp; he worked VS7AI on 7 mc. CVA reports from O.N.G. Camp. BJG also helped the boys at Camp keep in touch with home folks by keeping schedules with EXX and AWF. AMT receives appointment as Route Manager. DWB receives appointment as L.N.C.S. in the A.A.R.S. DQM is running two daily schedules and is building a four-band transmitter with switching arrangement. AIR spent the month working 14 and 7 mc. DDW is getting a new model Skyryder. BAR resigns as R.M., as he is going away to school. DSM drops A.A.R.S. work in favor of higher education; both he and BAR are going to Oklahoma A. & M. AVB finishes his work at Northeastern State Teachers College where he conducted a class in Physics (Radio), using the Amateurs Handbook as a text. Listen for his Official Broadcasts on Monday, Wednesday and Friday at 10.30 p.m., 1800 kc. KZ is rebuilding with 801's in final. ASF has taken up 'phone, discontinuing his work as D.N.C.S. in the A.A.R.S. and an O.R.S. BWN is appointed D.N.C.S. for Oklahoma First District, replacing ASF. Unit 5, Section 8 of the N.C.R., located in Ponca City is building a Unit transmitter; the call will be FBI. The Ponca City Key Clickers threw a picnic for the OW's, kids, and YL's. The OW's enjoyed the lemonade and the OM's the beer. BNF took unto himself an OW. Congrats, OM.

Traffic: W5CEZ 108 (WLJC 1) CJZ 56 CVA 47 BJG 26 AMT 18 DWB-DQM 3 AIR-DDW 1.

SOUTHERN TEXAS—SCM, Bradfield A. Beard, W5ADZ—OW says business is dull. MN gets WX for Meteorological office at Fort Sam Houston. BEF keeps traffic schedules. DWN will be at Army Camp in Las Vegas, N. Mex., for awhile. FDR operated as portable at Camp Hulén. ENR is working lots of DX. BFA is back on 3.5 mc. EXR/FCL will operate as portable at Camp Bullis. FHK is now NYL op at Texen. BWM is waiting for hot WX to scram. EPF has new FB7. AXH and BVH work X2CV and X2DH on schedule in a novel 3.9-7-mc. 'phone hook-up. BDI hooked FB8C and HHIL. OV is in Endicot, N. Y. BII, S.C.M., No. Tex., was portable at Camp Hulén. AID was also at Camp Hulén. BHO carried away the achievement cup at the Corpus Convention. FB. CUJ is proud of new HRO. AFV is working DX. DB is in Houston for awhile. ADZ is working DX on 14 mc. Sixth monthly meeting of G.V.R.C. was held in American Legion Hall in Yorktown, Tex., Aug. 10th. Talks on vacuum tube applications in ham receivers and circuits were given by CIX and PC. Meeting of "Royal Order of Watt" was held after regular meeting to discuss plans for convention program. EWI is having trouble getting rig tuned up to go. BYB is now on 7 mc. FBC is the champion VK snatcher in this neck of the woods. FFR is new ham in Hallettsville. EUO is QRL picture show business. DLO is QRL C. P. & L. Co. RA is QRL beer business. G.V.R.C. has offered \$5.00 worth radio apparatus as prize for first member to make W.A.C. after Aug. 10, '35. 9EMT is stationed at Cuero, Tex., with seismograph crew.

Traffic: W5OW 542 MN 187 BEF 50 DWN 14 FDR 13 ENR 4.

NEW MEXICO—SCM, Joseph M. Eldodd, W5CGJ—DZY joined the A.A.R.S. weather reporting net. DLG says he knows how it feels to be sleepy mornings—Hi. ELL has been working 28 mc. and reports it FB. CQL is reported as having been working DX with 10 watts input. CGJ finally got his rig back on the air.

Traffic: W5DZY 129 DLG 126 CGJ 22 ELL 2.

SOUTHEASTERN DIVISION

ALABAMA—SCM, L. D. Eilwell, W4KP—Our Director has been at camp. GYV will have the 500-watter on soon. AAQ is just back from vacation. CIU's antenna is down. CQO is active on 7 mc. CNU is contacting Birmingham every day. DGS is banging out on 1.75-mc. 'phone. AJY got report from Germany on 28 mc. DHG has a FB traffic total on 1.75-mc. 'phone. DMQ hopes to be on 1.75-mc. 'phone when the QRN lets up. BAQ is a newcomer to the ranks of Alabama Hamdon, being in the Army at Ft. McClellan. CJG is out for DX and a bit of traffic. DMZ is new reporter from Marion. Thanks, OM. DEO at Boy Scout Camp has a fine traffic total and is anxious for O.R.S. KP has been in Peoria, Ill. BOU got new rig on. ANT reports activity low due to weather.

Traffic: W4DEO 44 BAQ 39 DHG 29 DGS 22 DMZ 15 CYV 12 CJG 10 BOU 1.

EASTERN FLORIDA—SCM, Philip A. McMasters, W4BCZ—ASR is building a 300-watt c.w. rig for Trunk Line "C" use. BNI visited CLW and Orlando gang and AVQ at Camp Flaming Arrow. CQD worked FB8C, which now makes him $\frac{1}{2}$ W.A.C. BIN threatens to return to Texas if an operating job is not found soon. DOM, YF of DBA, is sick in bed and is missed by the 1.75-mc. gang. CQZ moved to Ft. Meyers. BCZ is having a swell time watching a new Dumont 145 Oscillograph. Gang, believe it or not, it only takes 45 mills on the Class B '46's to modulate 40 watts input 100 per cent. AFC has an RK-20 driving a "261A" in a 200-watt rig modulated by '46's Class B on 14 and 3.9 mc. The S.C.M. wants some applications for O.R.S. from Tampa. He hopes to see you all at the Miami Convention. It will be a big thing with the Coral Gables, Coconut Grove, and Hialeah Clubs helping to put it over.

Traffic: W4ASR 30 BNI 2 BIN 5 BCZ 1 CQD 25 DBA 2. **WESTERN FLORIDA SECTION—SCM, Eddie Collins, W4MS—Route Managers: 4AUW and 4ACB.** BJF is on again and is getting out FB. 5EBF was a visitor to the Section. OH has been working portable from Ft. Walton. BFD, QK, CUV and 3FAD/4 are changing QRA's. CNJ has been QRL flying. 3FCD/4 has been buying out BGA. CTZ passed Commercial ticket, Class "B" and Class "A," and landed a job in Honduras. Hate to see you go, OM, Luck. AUA is looking at 56 mc. ACB returned from vacation with new parts for more power. AUW is busy with 28 mc. and doing FB. BOW is doing U.S.N.R. work. BKD and BPI will be returning to school. BBJ is doing FB work on 14-mc. 'phone. DEZ takes care of 7 mc. ASV, ART, DQB and QU made U.S.N.R. cruise. DIC is happy over his new 866's. DAO lost a power transformer. 6VN and 6ASP are in training at the Naval Air Station. COG admits YLitis. Ex-9FDA is applying for a call. ABK is the proud owner of an ACR136. AXP is improving the present rig. KB has an '04A. AGS and KB are issuing an FB bulletin called the "Dope Bucket." AQY has moved his rig back to De Funiak where he will be heard on week-ends. CQF is busy with U.S.N.R. work. SZ will be back on shortly. PBW is building 1-kw. rig. QU and ASV keep HQ on the air plenty. ACB is working hard on the 56-mc. rigs. UW is back home with the gang for a while. CLP and DGG are still having their fight with QRN on 1.75 mc. CUR has an FB 1935 sig. CRU is heard on the air. Ex-4ARD is now 6JIP and visited the gang this month. Lots of the gang are planning on going to the SOUTHEASTERN CONVENTION in MIAMI in OCT., so let's get going fellows. MS is busy rebuilding 7-mc. rig and working on a 56-mc. antenna to increase the rig's range. How about some O.R.S. applications, and let's move a little traffic.

Traffic: W4KB 16 DIC 5 AXP 6 HQ 8 DHC 8 COG 3 DAO 2 MS 9.

GEORGIA-SOUTH CAROLINA-CUBA-ISLE OF PINES-PORTO RICO-VIRGIN ISLANDS—SCM, Bannie L. Stewart, W4CE—Ass't SCM Georgia, G. C. Hinshelwood, W4BBV. Ass't SCM Cuba, B. B. Greer, CM8YB. Chattahoochee Amateur Radio Assn. held a 56-mc. field meet and a QSO party on 7 mc. BBV is using break-in on 3.5 mc. AAY has been superceded by ATZ as S.N.C.S. of the A.A.R.S. 4th Corps Area with BBV as alternate. BBV visited Halifax, Canada, meeting enroute VE3TX. On Sunday, Aug. 18th, the Munroe Radio Club held a hamfest with 55 present. BAG was in charge of arrangements which included a magnificent barbeque in the woods. BBV addressed the gang on subject of the State Net, and BTI gave an interesting talk. A number of interesting contests were held. For the YL's and OL's a talking contest was staged, which was won by Mrs. 9SZM, who is now living in the South. CDH and BAG held a rag-chewing contest, a walk over for CDE as he gobbled up the string. Various worth-while prizes were distributed. Clubs represented were Atlanta, Athens and Gainesville, with a full turn out from the Munroe Club. CM Atlanta, BAG Monroe and VX Columbus have consented to act as district O.R.S. in the State Net. One has to be heard from in Savannah and the preliminary set-up will be complete.

Traffic: W4DQH 4.

DELTA DIVISION

LOUISIANA—SCM, W. J. Wilkinson, Jr., W5DWW—
 What Ho! And did we have a convention?! A hundred
 hams from four states gathered in New Orleans for the big
 time on August 24/25. This New Orleans gang really pulled
 a fast one. Here's the gossip on the gang. CYI won a pair of
 filter condensers. DMF really had a swell time. FHH is a
 brand-new ham. ZV, the timid YF of the group, would
 hardly speak. ST, EVZ, EBZ and AO were all QRL at the
 beer party which was given by CXQ and the Shuler Supply
 Co. FR and AXD took in the city. AXD was one of the most
 bald-headed attending the convention, while DMF had the
 largest feet (No. 11 shoe); CMQ was close with a size 10½.
 SI and DKR were announced as candidates for the director-
 ship of the Delta Division. IQ tried his best to show all the
 fellows a good time, and we think he did. BPN and LA, the
 power kings, were both going strong. CW was always smil-
 ing. DUK—should have been DUCK. BZR likes crab sand-
 wiches and La Tropical beer. BUK came from the end of the
 Mississippi to attend the convention. DLD was on hand for
 his share of the fun. THANKS to all the YF's and YL's for
 their assistance in making the convention a huge success.
 DXK did a very excellent job of planning the convention
 program. A grand old man was Mr. Charles G. McLlwraith.
 JW worked hard. EBB and his YF enjoyed the meet. The
 R.L. Mr. Du Triel, was observed enjoying himself. EVS
 was always in a hurry. Let us extend thanks to the New
 Orleans Radio Club for the wonderful way in which the
 convention was conducted, and hope to see everyone present
 for the Monroe Convention next year. DAQ worked some
 DX. CVW has new 56-mc. transceiver. HR got card from
 "G." BPL has brand-new YF. CFG is working in Longview,
 Texas. CFF is in Lafayette. EMS has been silent due to ill-
 ness. BQD is on 1.75-mc. 'phone in Jonesboro. CTU is on
 7-mc. c.w., he was formerly of Santa Anna, Texas. BYQ is
 radio service man. DLD schedules ERV. EBB is new mem-
 ber of N.O.R.C. EVS is planning 'phone rig. BI is news
 reporter. ZV is the only Hamess in New Orleans. ACV is
 making run on S.S. *Cotesa*, UK, DMF, the R.L. and his
 YF and OQF-ZV and DWW had get-together. AOZ is
 going strong on 1.75-mc. 'phone. CXQ is on 14-mc. 'phone.
 JW is thinking of new antenna. CJO is interested in 14 mc.
 BPN and FDM are busy at WDSU. LA worked several
 "J's" on 14-mc. 'phone. BUK operates on 3.5 and 7 mc. PG
 is on trip to Orient. QJ is still interested in ham radio. ALZ
 was greatly missed by XYL in N.O.L.A. EDY and DXK
 worked hard on convention plans. EDZ enjoyed vacation on
 coast. DYR is planning new equipment. DKR and SI are
 candidates for Director. CWX is active in N.O.L.A. FCG is
 on in Lafayette. DHP is in Rayne. EKY has RME-9D re-
 ceiver and likes it. DXL attended convention. ZS and QH
 received DX cards. DXW is going to try 28 mc. ERV has
 800 modulator. EEZ is active again. CW is shipping out
 occasionally. WF left for Oklahoma. DKR wants your self-
 addressed and stamped envelope, as he has several thousand
 cards on hand.

Traffic: W5DAQ 17 CVW 21 HR 9 DXW 21.

MISSISSIPPI—SCM, J. H. Weems, Jr., W5CWQ—
 FBS reports for the first time—he is working DX on 7 mc.
 EFX has new Super-Skyrider and Tri-tet. EUQ keeps on
 having receiver trouble. BBX is building rack and panel job.
 EZA wrote a nice letter to the S.C.M. for his first report;
 says he has new Johnson "Q" antenna. DXG has new 100-
 foot mast with vertical antenna, and an EIMAC 50T.
 BJD is to be married. Congratulations, OM. AWU has new
 RME9. DEJ and CWQ will combine efforts this fall at
 CWQ.

Traffic: W5DEJ 4.

TENNESSEE—SCM, Merrill B. Parker, Jr., W4BBT—
 RM's: W4RO, W4AYE, W4AEP. AYE got a job! The
 Chattanooga Club held August meeting at home of LU on
 Signal Mountain. LU gave the gang a swell feed, and a good
 time was had by all. Among numerous out-of-town guests at
 the meeting were: BUD, OV, DRI, APF, CDQ, DQK and
 BQK. 5CWQ and 5DEJ spent several days with PL, during
 which time they visited several of the Chattanooga gang.
 New stations: DRE and DRI. DRE started off in a big way
 using a pair of '03A's in his final and a Comet Pro receiver.
 DRI is building c.c. rig and plans to use a 150-T in final

CZL, formerly of Chattanooga, is now active in Knoxville.
 ZP is back from California. DDF worked a VK4 with 15
 watts input. CYP is working with a P.A. outfit at Red
 Boiling Springs. DKW is working on 56 mc. CUP is still
 "that way" about a certain YL. CDC has new c.c. rig.
 CBA has a good Atlanta schedule which is really news in
 these parts! A dentist's bill made BBT's hopes for new rig
 QSB. By the time this report is printed, fall will be here and
 the traffic season will have reopened. We want to have more
 traffic reports, fellows. Remember: reports totalling one
 point and up help put our Section on the map!

Traffic: W4CKY 122 AYE 97 BBT 45 CBA 27 CBU 16
 DDF-DQE 15 PL 14 RO 6.

ROANOKE DIVISION

NORTH CAROLINA—SCM, H. S. Carter, W4OG—
 The S.C.M. wants to thank the gang for the wonderful
 way they are cooperating with him. Charlotte: The gang is
 certainly doing some hard work to get the Convention plans
 together. BFB, BQE, CXC and CLB attended the Virginia
 Floating Club meeting at Lynchburg. Durham: CUB's rig
 works better than ever since getting his tank con-
 denser back from WDNC. RV has about completed his new
 rig using all metal chassis and panels. TR is keeping some
 good schedules. OC has been experimenting with antennas
 and has finished up with a vertical. Asheville: ADG is get-
 ting out FB with a '52 in the final. FJ is on with a new rig
 with 200 watts on a pair of '10's. QA and CRW are on 28
 mc. TO is on after a long lay-off. GW ran 720 watts input to
 a '52, and things started blowing. CJN is going to school at
 Wake Forest this fall. Raleigh: EG added three new coun-
 tries to his DX list; one of them was a "J." BVE is on an
 auto tour of the West. CGL is working on 7 mc. BTC sold
 his rig to join Coast Guard, but missed it by 1½ inches. JB
 received orders to report to Charleston for two weeks' active
 duty in N.C.R. AFJ is joining the regular Navy. HV is doing
 public address work. AE has rearranged his rig and gets more
 soup in the antenna on 3.5 mc. BRT is working both c.w.
 and 'phone on 3.5 mc. BMW is QRL radio servicing and
 keeping the police transmitter on the air. BTR is away at
 camp. CDD is playing in an orchestra down on the coast.
 DW took part in the O.R.S. party. Concord: Thanks, TJ,
 for the dope. AAE sold his SW3. CTD moved to Washing-
 ton. TJ is on a 25-acre farm, taking a vacation from auto
 QRM. Kannapolis: DCR is on 7 mc. CXE will be on soon
 with an FB rig. Fort Bragg: CVQ is on 7 mc. with 600 watts
 input. DLM has new Patterson PR-10. DCW is working
 portable at the C.C.C. Supply Co. Graham: CJP has a high-
 power oscillator using a 211 with 125 watts input. COC has
 an All-Star Sr. and took Class A exam. CYN, CLJ, CLZ,
 CLH and AEH have been rebuilding. Warren: CJM is
 plenty QRL with work. Warren Plains: BHR says to look
 out when the A.A.R.S. starts up again. Tarboro: CCH says
 DX is "putrid" and is waiting for his new Comet Pro. Lex-
 ington: WX reports to let us know there is still a ham in
 Lexington. Winston-Salem: NC made a good showing in the
 O.R.S. Party. CGY, CYA, ABT, DCQ and OG took Class
 A. AEH received a card from an "OM" and is harder than
 ever to live with now. BWC has trouble getting out. CXF
 hasn't given up hopes of getting in Coast Guard and went
 back to Washington for a second try. BOH has two FB
 racks for his new rig, also a new gas buggy. With the
 'Phones: BXF is testing on 3.9 mc. with a pair of '48's in the
 final. BX has trouble in trying to go from 14 to 3.9 mc.
 ALD says the weather has him down. BFB wants to know
 what's happened to the 3.9-mc. 'Phone Net. CLB would
 like to get in on the Net, but choir duties prevent it. AH
 sold his 1 kw. to BMR, but decided he couldn't get along with
 low power so he again has a kw. ANU is on 3.9 mc. about
 every night. CEL went fishing and has been troubled with
 chiggers ever since. AEH is having the same trouble only
 worse. HI. CDQ is rebuilding. CJQ is down with the heat.

Traffic: W4CYA 13 NC 12 CXF 11 CJP-CJN 8 CVQ
 5 DW-CJM 3 OG 2 BYA-WX-BHR-CCH 1.

VIRGINIA—SCM, Neil E. Henry, W3BRY; Asst.
 SCM, C. C. Morrison, W3BIG; Chief RM, R. N. Eubank,
 W3AAJ—EUL keeps regular C.C.C. schedules and is con-
 sidering O.R.S. AAJ lined up swell R.D. contest. EYN had

swell time at Lynchburg 'fest; he is going to college this fall. CNY is active on 3.9-mc. 'phone. FJN, new station in Petersburg, sends in first report. FB. CFV is active on 1.75 mc. EAP has 450 watts on 7208 kc. BIG says traffic is very light on 'phone nets these days. BZE is rebuilding for the winter. DHZ has new FBXA. AAF is building 'phone and c.w. rig. ASK has new HRO and is now on the air. BZ is very active these days. CYM says too hot in his shack, hi. ENO is using 66-ft. Zepp against ground. ECQ will be in RDC. ELA hops to be on again soon. AIJ keeps schedules with BIG every morning. BTR needs only Africa for W.A.C. FKD, new station in Petersburg, is operating in H.F. end of 7-mc. band. EZL was heard in Germany 449! FB! AMB is now on 3575 kc. with 211-D final. BFW puts 325 watts into an '03A. EEN is back on 3.5 and 7 mc. for winter. CGR says too hot to do anything but chew rag on 56 mc. FHP sends in first report. FB. BRY has rig about completed. EZJ worked HHP and hoisted power. CFLJ just got back to Richmond. EHL is building swell rig. UVA is rebuilding. MQJ is working on battery-operated rig. EBD blew power transformer. EGD is operating at FJN mostly. 4BMH went to S-Georgia on vacation. ELF is building new power supply. GE has new daughter! His third. BIW is going to put metal tubes in new receiver; he sends in swell dope on Danville gang. FBW suggests a '03A as first prize in RDC. AVR will be on this fall. KU sends lots of dope on Norfolk gang; he added an '03A to his rig. EOO is papering the house with Comm. tickets, hi! It's not too late to get in the big Roanoke Division Contest, and you may win one of the big prizes! First three prizes worth fifteen, ten and five bucks, respectively! Be sure to send in your log with your report before Oct. 20th, and report regularly each month. Start petitions for man of your choice for S.C.M. as soon as possible so there will be no slip-up when Dec. 15th rolls around. Get in Rke. Div. Contest and help put Virginia up on top. Thanks, all.

Traffic: W8EUL 7 AAJ 1 EVN 15 CNY-FJN-CFV 3 EAP 2 BIG 4 BZE 3 DHZ 8.

WEST VIRGINIA—SCM, Dr. Wm. H. Rihedaffer, W8KKG—JWL, DDJ and LBE have new Class A tickets. HGA worked VS1BO to qualify for fourth W. Va. W.A.C. certificate. KGT was recently married. LII and LTD are new O.R.S. MOL is new O.P.S. LNR is to attend Marshall College. FVU is building new rig with a pair of 50-T's in final. LTD visited 3DVO during last O.R.S. party to find out the low-down on them. He found out. Hi. MCR worked ON4RX. JRL worked J5CC twice in one week. FB, OM, Prof. and Mrs. Louis M. Kline are taking a vacation, visiting West Virginia stations on their silver wedding anniversary. HWT, O.B.S., is transmitting Official Broadcasts on Tuesday and Friday evenings at 7 p.m. on a frequency of 3700 kc. The new Route Manager for Northern West Virginia is Prof. Louis M. Kline (W8HWT). His fine station and his consistent operation will furnish Northern West Virginia with a real outlet for traffic and a real rag-chew at most any time.

Traffic: W8KKG 92 (WLEN 20) LTD 42 MCR 21 LXF-HWT 8 OFE-NMD 5 ELO 2 JWL-FQB 1.

ROCKY MOUNTAIN DIVISION

COLORADO—SCM, Glen Glasscock, W9FA—Activity is on the increase. Don't forget, drop the S.C.M. a card around the 16th, every month. EII visited 6MLC who spent the summer in Gunnison. IFD has been spending his time on 56 mc. and low-power 'phone work on 3.9 mc. TOX worked a ZL with a single six-year-old 205D. TOS is building a 1.75-mc. 'phone using a pair of 59's suppressor modulated. 'TOW moved to Denver and is working in a do-nut factory. SVL has a pair of '10's in P.P. with about 100 watts input on all bands, including 1.75-mc. 'phone. PWU reports round-table 'phone QSO's each week-day at noon including 9KQX, 9RGK, 7BCL, 7CEO, 9RGX and 9PWU. Some are on 3.9 mc. and others are on 1.75 mc. FIF doesn't modulate very heavy in the early mornings because he doesn't want to awaken his room-mate. RGX is a Roman Catholic Priest at Keensburg. "Bern" is well known to the 'phone hams at his old QRA and is fast becoming one of the gang in Colorado. PVY is back on the air after being off all summer. PO tried 'phone work and likes it very much. 7EDW has

his new low-power rig working on 3.5-mc. c.w. located near Westminster. SEX had a 5-hour QSO with FMX at Nickerson, Nebr. MOM is QRL C.C.C. Camp NP-7 at Estes Park; he is foreman and in charge of radio communications for the camp. EHC is QRL work. OTR reports that 4CA is moving from Santa Fe, N. M., to Denver. GLI spent two weeks aboard the U.S.S. *Cincinnati* and the U.S.S. *Henderson* on N.C.R. cruise. SBB joined the N.C.R. TDS passed his telephone second-class exam. MDN has YL trouble. MLU is returning to school at Gunnison. LQO spent two weeks on the beach while the OM, GLL, went on his N.C.R. cruise. TTD is making a trip to Missouri. CIO from Kansas visited Rocky Ford while on vacation trip. The Rocky Ford Amateur Radio Association is planning big blow-out in celebration of its third anniversary. KSE has trouble with his crystal hopping around. PGS went on extensive vacation trip thru the East and South, visiting many hams. FG didn't go to the Great Lakes after all, spent most of the summer right around the University. JRV is at Boys' Camp. SAX has new ACR-136 receiver. YL is still at University Camp. KJQ of Grand Island, Nebr., visited Denver hams. GHY invested in a velocity mike. EMU has new 'phone rig on the air. FHX tried a Jones exciter unit and says it is FB. NUZ changed QRA by a few blocks. OUI and IPH are building up a new metal rack and panel job good for about a kilowatt on 14 and 7 mc. TWT worked a K6 on 7 mc. with about 25 watts input. UZP is a new Denver ham. IVT, AAB, and ESA attended the Jenny Lake Hamfest. GLG at Leadville is chasing bugs in a Tri-tet. OLL threatens again with a 14-mc. 'phone rig. SXI at Trinidad installed a pair of Taylor 825's in final. PRI of Lenora, Kans., spent his vacation in cool Colorado. 7CYN visited Denver by plane. DCY is trying controlled carrier 'phone. SLE worked VPIAG, just off the east coast of South Africa, with his RK-20 rig. 6MLL of Nogales, Ariz., was another visitor in Denver. ODF added a WE216A in his rig. RXZ is going to increase power in the final. PTI has a new YL operator in the family. BCW has a new rig and new receiver. DDF put up a new sky-wire. BTO is still rebuilding. BVZ has been spending his time on audio amplifiers and recording devices. JB spends his time on 14-mc. 'phone. BJN spends most of his time examining taxicabs for the Police Dept. MKN has been QRL business outside the city. EGY enjoyed the 59 'phone rig so well he is building up a larger rig. EYN got hitched up during the past month. HQV still wants to get into the N.C.R. JFD changed his QRA again. NEY was plenty busy with convention preparations. FQK also had his hands full of convention plans. NLD plans to go to Boulder to school. The 9th Annual Divisional Convention was held at Greeley on Aug. 31st and Sept. 1st. There were well over 100 hams in attendance as well as numerous YL's, YF's, and OW's. The large number of hams from other sections was one of the highlights of the convention. Nebraska, Oklahoma, and Texas were well represented as well as one ham from N.Y.C. and one from Calif. The banquet on Saturday evening was the high point. There were prizes galore for all. A political session concluded with a lengthy discussion of A.R.R.L. policies and plans for the future conducted by the Director, 9AAB. A picnic lunch in the convention hall ended the two-day gathering.

Traffic: W9PWU 31 IFD 11 MOM 10 OTR 6 PGS 4.

CANADA

MARITIME DIVISION

MARITIME—SCM, A. M. Crowell, VE1DQ—HH still maintains daily schedules with "BB" and had recent visit from old pal, ex-K6CLJ. HG has his rig stepping out on 14 mc.—50 countries to date. EP has 60 countries nailed up. HK is rebuilding with 211 final. FQ has rebuilt the 1.85-mc. 'phone rig and increased output considerably. DQ has an s.s. super with crystal filter an' all the trimmin's. FN has been giving 14 mc. a whirl with low-power 'phone. AG threatens to get an SW5. IVI is a newcomer in Montague, P.E.I. (CE's brother). AX expects to hit the air this

fall with another new rig. BH built himself a Lamb s.s. super. AR, GR and HQ still hold regular schedules and ragchews on 1.9-mc. 'phone.

Traffic: VE1HH 5.

ONTARIO DIVISION

ONTARIO—SCM, S. B. Trainer, Jr., VE3GT—MB has had many visitors and is QRL business. AAC and AAZ are rebuilding to c.c. and t.r.f. receivers. GI has a 59 c.c. AU has a tape for 28-mc. tests. SZ snagged a VK5 and an EA7 on 7 mc. AEM reports for first time; thanks. VD still keeps schedule with G on 7 mc. JT and GT keep but one schedule a day. AAG wants an O.R.S. For first time in years 9AL reports no traffic, but reports just the same. MX is still rebuilding. SS reports HR now married. Congrats SG has been on from summer place. WK is always on in early a.m. As this is my last official time to report Ontario activities as S.C.M., I wish to express my appreciation to all those who have so greatly aided me and the A.R.R.L. in our Section. May I especially thank the R.M.'s and O.R.S. and the Ontario stations on Trunk Line "L." It is such an easy thing to do on the 16th of each month that I hope the next S.C.M. will be so swamped with reports it will take him a week to sort them out. Let's all report and aid the next S.C.M. in his work. Ontario has improved its position in A.R.R.L. Sectional standing and there is no reason why we cannot be in the first five in the next two years. Let each and every one lend a hand to the next S.C.M.

Traffic: VE3MB 7 GI 1 AU 22 VD-GT 1 JT 11 AAG 14 EM 3.

QUEBEC DIVISION

QUEBEC—SCM, Stan Comach, VE2EE—HK is once more with us from his new location, and the completely rebuilt rig sounds beautiful. We regret that he will be unable to carry on as R.M. Thanks to DD, EC, HH and the other fellows who found time to write concerning their activities. DD has his motor-boat and YL to look after. EC has been trying 14 mc. CO is working on the SKY-WIRE. He solicits your support, one and all. We understand the bug has bitten DU again and that a 40' pole sits upon his house. DM has erected a 14-mc. vertical and gets out FB. The C.G.M. has discarded one and gone back to his first love, the 3.5-mc. horizontal. The sons of Nippon have been breaking thru again and another W.A.C. has been registered in the person of DR. Ray at EW needs the African to complete his continents. The S.C.M. had the luck to get the old 'phone across to Tokyo for the 'phone W.A.C., thanks to J5CC. The 1.75-mc. boys are still having lots of fun on that band and BO is a new one in their ranks. GE was also heard up there. JJ seems to be one of the Kingpins on that band. JK puts out a very FB signal on all bands. AP and CX have been logged. FQ will be back home by now. Old Doc at DG deserves a medal for the time and trouble he went to in keeping FQ in touch with the ladies. FG is having a great time with that 'phone; between the Johnson Q and the Mexican crystal, Bill certainly is busy. Congrats to CJ on the arrival of a YL. KK is having trouble getting that bed-spring to tune. The newcomers are requested to please drop the S.C.M. a line. Beginners interested in code practice can listen for VE2IO at 9 p.m. every night on 3526 kc.

Traffic: VE2HI 31 IO 26 JK 28 BU 15 BB 6 HH 4 DR 3 CO 2 CA 3 EC 8.

VANALTA DIVISION

ALBERTA—SCM, J. Smalley, Jr., VE4GD—Booths in western exhibitions gave some of the boys fine totals with LX, now operating both 'phone and c.w., leading the way as usual. EO acted as chief man at the Lethbridge Fair and originated over the hundred mark. QK, BZ and GE also turned in nice totals. Many of the provincial hams have been traveling around the country on holidays, and W7ABT has had visits from about 20 VE4's due to his high-power publicity work. About 10 VE4's took in the Spokane Convention. SW visited the Jenny Lake Hamfest. The A.R.E.A. will resume regular monthly dinners (first Friday of each month) commencing September at the York Hotel. Elections keep CFCN on the air and JK off the air operating the BC rig. XX is a new station at Sylvan Lake and not a bootleg. JW is now authorized to use 3.9-mc. 'phone. BA and GY are also using 'phone. FI and HW are still snagging FB DX.

WG is building a 1.75-mc. 'phone rig. AW is coming out of the North to spend the winter in civilization. SD is getting the Frontieramen Network lined up across Canada and it looks like duplicating the U. S. Army Net. LA is now using 801's in place of his '10's. 4GM is on 14 mc. CW is proud of his DX cards. Please let us have your reports, gang.

Traffic: VE4LX 205 EO 105 BZ 57 QK 52 GE 39 GD 4.

BRITISH COLUMBIA—SCM, R. K. Town, VE5AC—FU is working some fair DX. GI hopes to be W.A.C. soon. BC holidays among the W6 and W7 gang. BJ has taken advantage of the season to rehash his heap. The B.C.A.R.A. had a beach get-together on July 27th. The Vernon gang have formed a club and are away to a good start. B.C.A.R.A. meetings are very well attended for this season of year. Plans are going ahead for a mountain climb with 56-mc. rigs. NL is the big enthusiast. JH and EU are organizing Vancouver Pacific exhibition station under auspices of B.C.A.R.A. Another VE5 Contest will be held soon as arrangements can be completed. The Okanogan Amateur Radio Club held a very successful picnic at Otter Bay, July 14th. ID is having his troubles with a c.c. rig. JE is taking a summer cruise on survey boat. CV is very active with Y.M.C.A. camp traffic. AV is active on 'phone and c.w. with the Island Net. MO is most active interior station. LA reports for first time. Come again. DB is Y.M.C.A. camp station. LX has a nice total. GI likes traffic but prefers DX. KC says "traffic is OK but give me DX." IN is among the B.P.L.ers. JL is a good steady traffic man. NG goes visiting hams in Victoria. AC is back on T.L. "I" after summer holiday. BH is heard on 7 mc. Let's go, gang, for a big season.

Traffic: VE5ID-JE 1 CV 214 AV 69 MO 240 LA 3 DB 467 LX 86 GI 81 KC 146 IN 141 EP 59 JL 164 NG 3 AC 33 BH 2. (VE5MO 160 June-July.)

PRAIRIE DIVISION

MANITOBA—SCM, A.J.R. Simpson, VE4BG—AG is back from vacation and will be taking up schedules again which were carried on by TV during his vacation. CD is getting rig cleaned up for fall. MV is active on 14-mc. 'phone and c.w. MW is getting ready to put up a new sky-wire at his new QRA. MY has filament of T250 lit up in final and is now looking for plate juice. The two ops at NI will be QRL during September for vacation and moving to new location. RO is putting out lots of power on 14 and 7 mc. and hooking DX. TJ has been having rectifier trouble. UX has left Winnipeg and moved to Montreal where his call is 2KO. Look out for Bill, gang. We are also losing IC, who has sold out and is moving to Vancouver where he will be heard as a VE5. Good luck, Vernon. VF has been QRL during removal to new QRA. VI is still busy looking for 14-mc. DX. QF has swelled 70-foot pole and is to be heard on 7 mc. DU and KX are hooking plenty of DX. GC finished rebuilding and is active. The M.W.E.A. held its annual Field Day Aug. 11th at Fairhills and had a large turnout. It was a party for the YL's and XYL's and was a real success. MY and QF took the honors in most of the running events and SS copped the 56-mc. QSO prize, GL and AG pushing him right along.

SASKATCHEWAN—SCM, Wilfred Skaife, VE4EL—Due to the absence of Mr. Skaife, S.C.M., VE4CM has prepared this month's section news. QZ hooked his first K6 and K7 on 7 mc. MB is visiting in Los Angeles. UC and UG are active on 7 mc. with C.C. rigs. PQ is active on 14 mc. trying to hook DX. UH is running P.P. '45. PW will soon be on medium power. TN has just completed FB superhet. S.A.R.C. ham exhibit at Saskatoon Exhibition was highly successful. 'Phone was used on 3.5 mc., considerable traffic being handled. EL is taking life easy on holidays. OO joined the Benedicts. KM is working on 100-watt c.c. rig. XM tried crackle finish at 600° with all parts assembled but, lo and behold, all his solder melted. Hi. UK is enjoying beach. XL tried hard to get Tri-tet working. FY fed his outboard motor to GA's big fish. EH and PM are up north working commercial rigs. JH works VK, ZL, F, SM, K6 and X. HL is very busy. ML blew XM's 866. NP is still gathering junk. AO trying hard for a "hole in one." CM is busy on T.L. and also on 3.9-mc. 'phone. MH is playing with 2000-volt transformer, product of CM. Well, gang, let's get going.

Traffic: VE4QZ 3 CM 86 MH 78.



CORRESPONDENCE

The Publishers of *QST* assume no responsibility for statements made herein by correspondents

R-S-T

Auburndale, Fla.

Editor, *QST*:

I have read with considerable interest the letter from Arthur M. Braaten, W2BSR, printed in the Correspondence Section of August *QST*, and heartily agree with him that the R-S-T scale should be changed to have nine divisions for signal strength.

Even though it is perhaps a fact, as suggested, that the human ear cannot distinguish consistently between changes in signal strength equivalent to one-ninth of the scale, still, the amateurs are accustomed to the 9-point scale and I am sure the majority of them prefer it. Personally, I believe a person can discriminate between an S6 and S7 signal, now reported as S4, and it gives the operator who is putting out the signal a better idea of what he is doing.

I have not felt like using the R-S-T system as it is now set up, but if it were changed as suggested I would use it whole-heartedly; and am sure there are large numbers of other amateurs who feel the same way about it.

—Kenneth N. Sapp, W4AWY

Southington, Conn.

Editor, *QST*:

In regard to the suggestion made by Braaten, W2BSR, in your August issue for modifying the R-S-T scale so that S would have a group of numbers corresponding to the old R scale of 1-9, I don't see why we need nine numbers to indicate the signal strength. On the contrary, the present R-S-T system is more efficient and tells the receiving operator exactly what he wants to know. Furthermore, I think it would be a splendid idea to carry this thought along and reduce the tone scale to five numbers; i.e., T1 for raw a.c., T2 for r.a.c., T3 for d.c., T4 for n.d.c., and T5 for p.d.c., with the addition of an "x" after the appropriate number when it is desired to indicate a crystal tone.

Outside of this last change I think the R-S-T system of reporting is quite an improvement over the old QSA way for reasons we all know. Most of the objections to the new system seem to me to be from fellows who have the old system strongly imbedded in their minds and are having a hard time to readjust themselves. The situation is more or less analogous to a poor golfer with a

faulty swing he's used for a few years who hates to change his style so as to improve his game. Let these fellows who are annoyed at the R-S-T scale use it for a time and give it a fair trial and eventually they will agree with the rest of us.

—Kurtz A. Fichthorn, W1BGJ

Sheboygan, Wis.

Editor, *QST*:

I partly agree with W2BSR on the R-S-T system of signal reports. I, as well as hundreds of other amateurs, do not like the R-S-T system as it does not give long enough range of signal strength. Many amateurs say they like the old standard system QSA1 to 5, R1 to 9, T1 to 9. The R-S-T system is OK if the old system is used R1, 2, 3, 4, 5,—S1, 2, 3, 4, 5, 6, 7, 8, 9—T1, 2, 3, 4, 5, 6, 7, 8, 9. The old T system is the only one that gives a correct report of the tone of signal. Most old timers and commercial operators, who are amateurs do not use R-S-T—they use the QSA-R-T system.

—Milton B. Tauscher, W9ACK

Minneapolis, Minn.

Editor, *QST*:

Thanks to W2BSR for suggesting a needed improvement in the R-S-T system.

—Paul Bauman, W9IJN

1201 S. Liberty Ave., Alliance, Ohio

Editor, *QST*:

I agree 100% with the revised R-S-T scale by W2BSR in Aug. *QST* and I hope that it will be adopted by all hams.

—Wm. J. Hartzell, Jr., W8ODB

EDITOR'S NOTE.—Attention is directed to the announcement appearing in the Communications Department of this issue.

Radiomen

Treasury Department, U. S. Coast Guard,
Washington, D. C.

Editor, *QST*:

I wish to thank you for the fine cooperation you gave the U. S. Coast Guard in filling the vacancies in the rating of radiomen.

In answer to that note you inserted in *QST* and the bulletin, we have already received about one thousand replies. I regret to inform those excellent men that I cannot find time to answer by personal letter but had to put out a form letter.

The applicants we examined here in Washington, which I am sure are a cross section of the large group, were far above our expectations; they were expert operators and technicians!

I am turning over a large list of these men to the Navy and I am sure that some of them will be given consideration. At any rate, their names will be kept on file for future vacancies.

—E. E. Comstock, Lieutenant (j.g.), U. S. Coast Guard

7150 DX

1173 N. Ardmore Ave., Los Angeles, Calif.

Editor, *QST*:

I have noticed a condition on 40 meters which may interest you and I would like to know whether anyone else has had the same experience. On a recent trip to Honolulu it seemed to me that signals around 7150 kilocycles were louder than those at the ends of the band. I was using the 800 meter antenna for receiving so the increased strength was not due to a tuned antenna.

On my return I consulted my log and was surprised to learn that most of the extreme DX I have heard was near that frequency. Have since logged Javanese PK1BO and Malayan VS2AG at the same spot. The good spot seems to lie within 50 kc. plus and minus of the center of the band.

Belting a 7180-kc. Zepp to my '10 I was rewarded with a South African contact in July, a rather difficult country to work at that time of year. It may be lack of QRM at that frequency or simply coincidence but the fact remains that the majority of good DX seems to be in the center of the band.

—Geo. Dery, W6HG, Ex-KESX.

Bootleggers

12 Public Square, Watertown, N. Y.

Editor, *QST*:

In the past few issues of *QST* I have been disgusted by letters by licensed amateurs who have been suggesting no-code tests, special calls and the like for 56 mc. and up.

In the first place, houses that sell transceivers will gladly give licensed amateurs the names and addresses of purchasers of such equipment. The local branch of Sears, Roebuck and Co. has just given me the name and address of one such ambitious local person. To my knowledge the person has not taken the test yet.

Directive receiving arrays in two or more points can approximately locate the source, and then a hand-portable receiver in that locality can boil it down to several houses at which time ringing doorbells for the owners in the middle of the transmission will show up the operator.

... It isn't the kind of spirit I like to just sit back and give in to the bootlegger. ... The only thing to do is to give him some resistance, but don't let him burn your resistance out!

—George Bonadio, W8OMM

Ultra-Short—Ne Plus Ultra

2147 Chestnut St., Camp Hill, Pa.

Editor, *QST*:

Several future hams, friends of mine, live on a farm north of Lewistown, Pa. They have been practicing diligently on the code for some months and are getting up towards the "legal limit."

They had rigged up a searchlight, of sorts, from an old Ford headlight reflector, for spotting things about the farm

at night. One evening they noticed a fixed light up on a ridge a mile or more away. The next evening the light appeared at the same place.

So they turned their searchlight in the direction of the ridge and keyed "CQ CQ." After a little wait the light on the ridge blinked a reply. As a result, for the next several evenings a QSO resulted. At the end of the week they said they would drop up to see the party, but were informed that camp would be broken up next day so they did not meet. Now my friends do not know whether they were QSO a bootlegger, escaped convict, surveyor, or just what! But there have been surveys in the vicinity for a new system of airway beacons and it was probably someone in connection with that work.

There is nothing new in the use of light beams for communication. But in these days of ultra-short radio communication, over short distances, and many times within the "line of sight" it is interesting to speculate on the boundary line between radio and light waves. In fact, there may be occasions where it would be easier to stick a key in the lighting circuit of the old fivver and key the headlights for practical out-of-door communication than to use the 5-meter rig.

Another point in this connection. The F.C.C. claims the entire radio spectrum comes under their jurisdiction, including the micro-waves. Possibly my young friends were violating the radio laws with their searchlight? Hi!

—Paul S. LeVan, WSMG

Reports and Receivers

7434 Park Avenue, Merchantville, N. J.

Editor, *QST*:

... Not having what was necessary to buy factory-built receivers, I was worrying along with various home-built ones. Not much success was had because of a bad hum and all d.c. c.w. notes were modulated to r.a.c. Even all-battery operation wouldn't produce good results, and as to a.c.—connected in any way—that was out. My transmitters always were OK.

Finally I gave up and decided I just couldn't build a receiver. W3QL kindly built one for me, at the same time telling me what kind of a ham he thought I was who couldn't even build a decent receiver. He did a good job and it worked swell when he finished it. Not a bit of hum or modulation. So! Came the time to take it home. We drove over and set it up. Wow, what a racket! Hum, modulation—terrible, we both agreed.

The solution finally arrived at was the relocation of the receiver. When another room was used everything was OK. The room where I had been using the receivers was right in the center of a field produced by three 2100-volt lines and two 220-volt lines which went up the street in front of the house and turned at the corner and went up the street. The house was on THAT corner! To make matters worse the house was wired with the old open wiring and no shielded conduit or BX work had been used.

So don't be too sure the other fellow isn't giving you the report he honestly hears. I would have hurt a good many fellows' feelings if I hadn't known I was having trouble and made allowances.

—R. W. Barrington, WSKW

Reason

De Funiak Springs, Fla.

Editor, *QST*:

... There seems to be a current feeling that the A.R.R.L. is not doing its duty to the hams as it should, but I discount this. We are not perfect and never will be. We are all prone to make mistakes that later we regret.

Now, this feeling of unrest in our ranks may conceivably be caused by well-directed propaganda—with a view of tearing our organization down from the inside—conducted by a few unscrupulous interests desiring our destruction for their

(Continued on page 74)

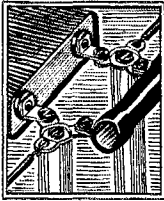

IN THE August General Radio Experimenter, they comment on the unfortunate effects of humidity upon insulators. This is so exactly in line with our own experience that we are calling your attention to it. As General Radio points out, the surface leakage under conditions of high humidity is very material. They suggest one practical remedy — operating the insulator at a few degrees above the temperature of the surrounding air. This is not always feasible of course, and in many cases all that can be done is to buy quality insulation and hope for dry weather.

Our experience leads us to believe that dirt is an even more common offender in most amateur stations. If an insulator becomes even slightly oily, it will collect dust and form a gummy film in a very short time. Oil has no place on an insulator, but it is apt to get there just the same from tools, bearings and fingers. So when you oil the bearings of your condensers, don't use an oil can. Carry a drop on the end of a wire, — and wash your hands afterward. Dust shields are a big help and are used almost invariably in commercial equipment. It is a detail that the amateur might well copy.

Elsewhere in this magazine, we confess that our new catalog lists a number of "gadgets" — little things that we found useful ourselves and thought might be useful to others. When we wrote this page in the catalog, we discovered that many of our contrivances were not new products at all, but old products used in an unconventional way. For instance, the little grid-grip which we make for the new metal tubes, is an almost ideal clip for trimming inductances wound with copper tubing. It makes a low-resistance wrap-around contact, and clamps in place. The grid-grip is in two pieces riveted together. Drill out the rivet and bolt the two halves together on the tubing. It can be removed by loosening the bolt, but it cannot fall off or pull off.

Then again, it is often useful to use our GS-1 and GS-2 insulators upside-down. These insulators have a metal base with three feet which makes an excellent three-point soldering lug. For example, in Heising modulation, one lug can support the voltage dropping resistor, another the by-pass condenser, and the third acts as the soldering terminal for the choke and modulator plate. A similar inverted insulator can support the other ends of the resistor and condenser, and provides a support for the R.F. choke.

JAMES MILLEN



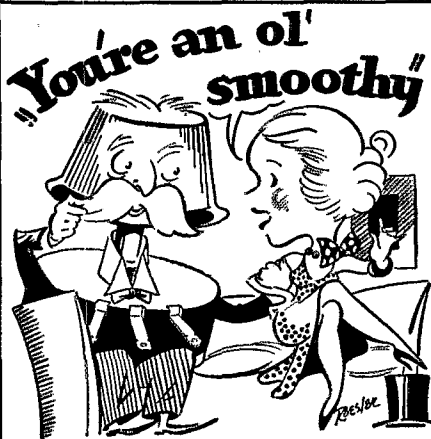

Yes sir . . . he's a smooth article . . . and that's why **SERVICEMEN** and **Experimenters** everywhere pin their faith on **CENTRALAB Controls**. Smooth . . . of course . . . for the **Centralab Radiohm** employs that famous patented non-rubbing contact that never seems to wear out and gives a replacement service that invariably works "better than ever before."

. . . and you don't need a big stock to be able to service practically any job.



Write or see your jobber for the new, revised accurate **CENTRALAB VOLUME CONTROL GUIDE**

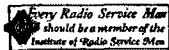

Centralab

Division of Globe Union Mfg. Co., Milwaukee

Correspondence Department

(Continued from page 78)

benefit and financial gain. These interests want our hands and will use any means to get us out of the way.

I believe most of the large makers of electrical equipment are with us and will help us retain our rights, for it is not only to their financial gain to do so, but the fact that there are many live experimenters in our ranks who are doing their bit to advance the art of radio in the long run reflects on their profits.

We have lots to thank the Army and Navy for, too, and we should be willing to cooperate with them at all times in any way we can.

I have met many hams personally and lots more over the air and as a whole they are a real fine bunch of men and boys that can be depended on when needed. Of course, there are a few who cry for the moon, but show me any other organization the size of ours and you will find a few of the same stripe and some of these are not all wet when you reason with them. . .

—Oscar Cederstrom, W4AXP

Performance

Department of Marine, Radio Branch, Ottawa, Canada
Editor, QST:

I enclose herewith copy of a communication from the Deputy Minister of the Department of Mines in Canada . . . which you may like to publish in the next issue of QST.

—C. P. Edwards, Director

C. P. Edwards, Esq.,
Director of Radio,
Department of Marine,
Ottawa.

Department of Mines, Ottawa

Dear Commander Edwards:

In connection with the operation of amateur wireless stations, you may be interested in knowing that two of the amateur stations in British Columbia have furnished assistance which this Department wishes to gratefully acknowledge.

On July 1st Mr. R. Bartlett of this Department broke his leg near Dease Lake, B. C. As soon as word could be sent to Lake House, at the head of Dease Lake, Mr. E. Latimer who operates the amateur station VE5LH, started calling and never rested until he established communication ten hours later with another amateur, Dr. Hocking in Prince George, B. C. Dr. Hocking wired Telegraph Creek from which place a plane and doctor left for Dease Lake and in two hours had Mr. Bartlett in the hospital at Telegraph Creek.

I understand that Mr. Latimer is not allowed to take payment for his services and would be glad to have recognition given to amateurs as a group rather than to himself. I am writing to Mr. Latimer and to Dr. Hocking and I am also glad to call this incident to the attention of your Branch.

Yours sincerely,
(Signed) Charles Camshell, Deputy Minister

EDITOR'S NOTE.—Commander Edwards, in transmitting copies of this letter to VE5LH and VE5FG, wrote each of these amateurs as follows: "I wish to congratulate you on the humanitarian service rendered by you on this occasion, and would say that it is services such as these which enhance the already high prestige enjoyed by our Canadian amateurs."

Wiping the Slate

4214 Country Club Drive, Long Beach, Calif.

Editor, QST:

We always enjoy reading your editorials and in a recent one you asked for suggestions with regard to the violations and if they seemed too severe.

It would seem to me that the set-up is about right at the present time except that the offenses should all be wiped off the calendar once a year like traffic offenses are in traffic court.

In other words, once each year, each amateur be given a clean slate.

Often these offenses are caused by the fact that an amateur will have three or four transmitters and he is trying them out.

He also may be trying band switching devices and the device may not work.

By using lots of transmitters and by having a wide variety of apparatus and an attempt at band switching devices and things, we are continually developing progress

Unvarying

UNIFORMITY OF RESPONSE

WESTON DB indicators

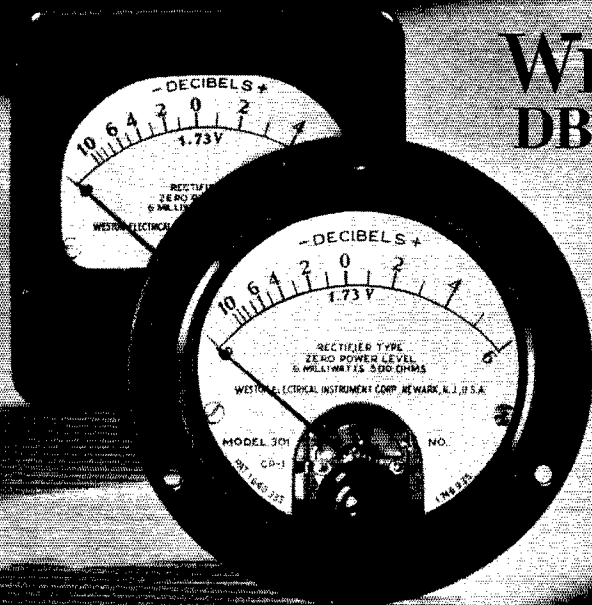

"Controlled pointer action" . . . is the way sound engineers compliment the unvarying response of Weston DB indicators. Skillful engineering, and years of experience in the manufacture of DB meters, accounts for this uniformity. Also, it explains the widespread use of Weston DB indicators by communication engineers, companies manufacturing monitoring control, and amateurs . . . *everywhere*. The line consists of three types . . . High Speed—Low Speed—and General Purpose . . . to meet all requirements. Full details available in bulletin form . . . Weston Electrical Instrument Corporation, 602 Frelinghuysen Avenue, Newark, N. J.

WESTON *Instruments*

Dials

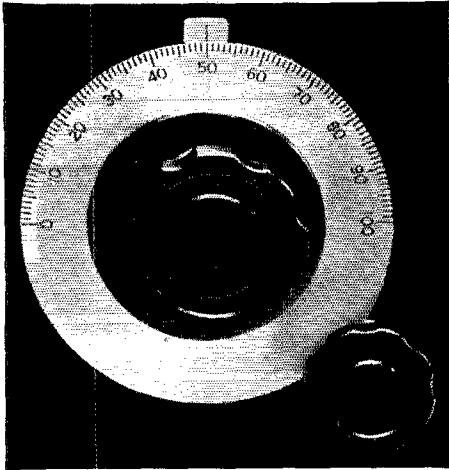

TYPE 702-F FRICTION DRIVE

GENERAL RADIO dials are used in increasing numbers not only by amateurs but also by manufacturers of commercial and amateur equipment as well.

Simple to mount . . . positive in action . . . easy to handle . . . capable of being set accurately . . . they enhance the appearance of any piece of equipment.

The general utility type of General Radio dial is available in diameters of $2\frac{3}{4}$, $3\frac{1}{4}$, and 4 inches . . . knobs for either $\frac{1}{4}$ or $\frac{3}{8}$ inch shafts . . . with and without friction drive . . . and priced from only \$1.00 to \$2.00.

These and other General Radio amateur products are described in *Bulletin 936*. Have you received your copy?

General Radio Company

30 State Street Cambridge, Mass.



although it is rather discouraging to a chap, I imagine, who gets caught by something slipping, if he feels it will be held over him for the rest of his life.

As it is now, they dig into archives and find something that happened many years ago.

—Don C. Wallace, W6AM

Salvage

5917 Edna Ave., Baltimore, Md.

Editor, *QST*:

For a number of years I have been working for a firm which is the largest dismantler of ships in the U. S., and being a true ham I never let an opportunity go by to acquire some piece of electrical apparatus to use in the "ole station." None of the equipment on these ships is modern, and therefore has been altered so as to be hardly recognizable, but it is nevertheless from some very famous vessel.

Several of the switches are from the old battleship *Alabama*, which was sunk in bombing tests by ex-Gen. Wm. Mitchell and started that great controversy about battleships being obsolete in warfare. After several years on the bottom of the Chesapeake Bay the *Alabama* was raised and scrapped.

The key is from the S.S. *Jacob Luckenbach* which went on the rocks off the west coast of Mexico under unusual circumstances, and after being temporarily patched was refloated, found unfit for repairs and scrapped.

The latest addition is a power pack made from salvaged parts of a power amplifier used on the ill-fated S.S. *Morro Castle* which is now in the course of being scrapped.

The lamp on the desk over the receiver and some of the brass used in the transmitter is from the most famous German raider, the *Prinz Eitel Freidrich*, which under command of Count Von Luckner made an undying name for itself in raiding allied shipping during the Great War.

The desk and meters are each from a different ship used by the U. S. Shipping Board during the War to transport supplies to Europe.

The antenna is from the old U. S. Cruiser *Cleveland* which while being towed to Baltimore to be scrapped ran aground in the Virginia Capes, and in efforts to free it a large government tugboat was overturned.

And so it goes—parts from "Ghost Ships" famous and infamous, men-of-war, rum-runners, sea raiders, passenger vessels and freighters, but all helping to make up a ham station. . . .

—W. R. Jones, W3CAQ

Book Reviews

Radio Design Practice (First Edition), edited by James Millen, with drawings by M. B. Sleeper. Over 150 pages, exclusive of catalog listings. Published by James Millen, Inc., Malden, Mass. Price, \$1.00.

When the designer of a radio transmitter or receiver tackles the problem of planning a mechanical assembly he can follow one of two lines of procedure. Either he can collect an assortment of parts and panels which he thinks may do the job, and then cut and try until a combination fitting his circuit is reached; or, doing without the collection of parts, he may hunt up mechanical data on various components of the proper electrical ratings and plan his layout completely on paper. The latter is, of course, the logical engineering method. But where to get, in one compilation, the necessary mechanical information, especially dimensions? That is the problem to which *Radio Design Practice* offers an answer. In this first edition are data on, and photographic illustrations of, a wide variety of standard radio transmitting and receiving gear representing some ten manufacturers, including such well-known names as Aerovox, Delta, Electrad, Federal, General Electric, General Radio, National, Sylvania (tubes), Western Electric, Weston.

Exceptionally readable dimensioned drawings of compo-

*Really
stable*

**SHORT-WAVE
RECEPTION**



MODEL A-82

... with General Electric Receivers

For 1936, General Electric offers these notably new features that keep the set always at "concert pitch."

- All-metal tubes make possible higher R.F. gain with consequent great improvement in signal to noise ratio. (Important for short-wave reception.)
- Permaliners — The first production receiver equipped with air dielectric trimmer condensers that are individually enclosed and protected against moisture and dust.
- Short leads from tube elements to tuned circuit made possible by:
New Metal Tubes.
Coils Mounted Directly on Switch Points.
- Good mechanical design—efficient placement of parts—self-shielding metal tubes and sentry box.

The chassis is specially designed to include every advantage that results from the use of metal tubes and short leads. It meets the exacting requirements of short-wave listeners and amateur operators. An extremely sensi-

tive and selective four-band receiver, tuning 49, 31, 25, 19 and 16 meter bands. Eight metal tubes. Sentry Box. Permaliners. Sliding-rule Tuning Scale. Stabilized Dynamic Speaker. Noise Control. Automatic Lo-note Compensation. Power Output—4 watts undistorted. Maximum Volume Output—6 watts. CW Oscillator may be added.

\$94.50

(Eastern List Price)

(Mail This Coupon for Oscillator Data)

General Electric Company,
Bridgeport, Connecticut.

Attention: Sales Promotion Section R-1610,
Please send me Data Sheet FS-58 "Beat Frequency
Oscillator", and complete details of G-E Radios
with the metal tubes.

Name.....

Street Address.....

City.....State.....

GENERAL  ELECTRIC

RADIO

MERCHANDISE DEPARTMENT, GENERAL ELECTRIC COMPANY, BRIDGEPORT, CONNECTICUT

Say You Saw It in *QST* — It Identifies You and Helps *QST*

You Will Want To STANDARDIZE TO THIS DESIGN

by
TRIPLET

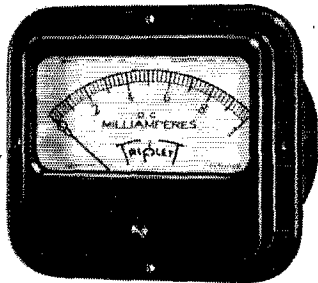

FEATURING:

ACCURACY ■ BEAUTY ■ ECONOMY!

AMATEURS incorporating the popular 4"-square Triplet instruments in their equipment are very enthusiastic about the many advantages offered.

ADVANTAGES:

- (1) Maximum scale length with minimum mounting space.
- (2) Requires only 2 3/4" diameter; round mounting hole.
- (3) Spacious opening allows maximum amount of light on scale.
- (4) Symmetrically designed molded case for added appearance to panel.
- (5) Lowest possible cost for precision instrument.
- (6) Panels standardized with 4"-square instruments create beautiful effect.

This 4"-square instrument makes it possible to secure the same scale length of 5-inch instruments — yet it uses one inch less panel space. This important advantage adds a new note of modernity to the complete unit.

Furnished with spade or knife-edge pointer. Used wherever electrical measurements are required. Supplied in all popular ranges for: AC or DC Voltmeters . . . Millivoltmeters . . . Ammeters . . . Microammeters . . . and Milliammeters. Also thermo-ammeters for high frequency measurements.

Model

| | | | |
|-----|---------------------------------|-------|--------|
| 421 | 0-1 DC Milliammeter | | \$6.00 |
| 421 | 0-5 and above, DC Milliammeters | | 5.00 |

Net each to
Amateurs

SEE YOUR JOBBER

Write for FREE Literature

THE TRIPLET ELECTRICAL INSTRUMENT CO.

2 Harmon Drive

Bluffton, Ohio, U.S.A.

TRIPLET ELECTRICAL INSTRUMENT CO.
2 Harmon Drive, Bluffton, Ohio

Gentlemen:
Send me the facts on Triplet Instruments.

Name.....

Address.....

City.....State.....

nents ranging from relay racks to plugs and jacks are given, while photographic reproductions illustrate complete transmitter, receiver and speech input assemblies. The final section gives rating and application data on receiving tubes. Although the book is by no means a sales catalog, listings of some of the components are appended. The modern spiral-type binding is particularly convenient for drawing-board work, making the pages lie flat where opened.

—J. J. L.

Who's Who in Amateur Radio. Edition B, Published by Radio Amateur Publishers, 1107 Broadway, New York City. 138 pages, price 50¢.

Sub-titled, "The Radio Amateur's Directory of Operators, Stations and Schedules," this volume contains thumb-nail portraits in both words and pictures of a large number of amateur operators in all districts, to a number which we estimate to be approximately 2000. Typical information contained is age, occupation, other hobbies, description of transmitter, type of tobacco smoked, outstanding achievements, and personal idiosyncrasies. The only fault to be found with the volume is the rapid obsolescence of the information contained, leading to a number of notable errors. To believers in the adoration "Know thy fellow man!", however, it will be interesting and useful.

—C. B. D.

What's New in a Circuit

(Continued from page 25)

read. A meter cannot be put directly in the amplifier grid return lead because this lead also carries the oscillator current. Try different combinations of taps on L_1 to give the maximum grid current. This is a matter of but a few minutes' work, and once the optimum combination is found the taps need never be changed. The actual value of the grid current will depend upon the fixed bias voltage and the resistance of the bias source. With the particular oscillator power pack used the fixed bias was 50 volts (approximately cut-off for the 203-A), obtained by tapping across 1600 ohms at the negative end of the voltage divider. Under these conditions the grid current was 24 milliamperes with an oscillator plate voltage of 350, the oscillator plate input being less than 10 watts. With 500 volts on the oscillator, the grid current increased to 40 ma. The higher oscillator voltage gave but a small increase in amplifier output, however, so the set is normally used with an oscillator plate voltage of 350, since the lower voltage minimizes frequency creep. The meter in the center-tap should be removed when plate power is applied to the amplifier, because under these conditions it will read the sum of both plate and grid currents.

The alternative method of finding the correct settings for the taps on L_1 is to connect the amplifier to an antenna or dummy load and set the taps with a view to obtaining maximum output from the amplifier. This will lead to the same tap settings as the first method and requires no extra meters.

To couple the antenna, set the clips on L_3 one turn each side of the center, set C_2 and C_4 at minimum capacity, apply plate voltage to the amplifier, close the key and tune C_2 to resonance, indicated by the minimum point of the plate current dip as C_2 is tuned about resonance. The amplifier plate current should rise to 300 milli-

YES!!

we can supply from our stock 'most anything in radio in every leading line. GROSS caters exclusively to the RADIO AMATEUR.

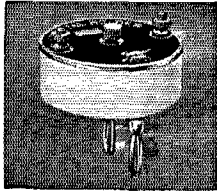

OUTSTANDING !! Gross Crystal Holder

WHITE CERAMIC commercial type crystal holder—priced at less than ordinary holders. Adjustable pressure, dust proof, no tools required to open. Takes crystal to 1 1/2" square. Plug standard 3/4" spacing. Most efficient job yet. \$1.00

The "EAGLE" Three-Tube Short-Wave Receiver

"Band Spread" over any portion of the tuning range — only the finest material used thruout. Employs one '32 R.F., one '32 detector and one '33 Pentode Audio — 15 to 200 meters — four coils, supplied. The "EAGLE" is economical — two dry cells will operate the filaments. "Eagle" completely wired and tested. \$11.95
Three tubes tested in your receiver. \$3.00

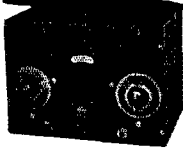

GROSS CRYSTAL CONTROL TRANSMITTER

CW-25 Transmitter kit 25-30 watts. With one set of coils. \$14.95
(see August QST p. 67) (Catalog on Request)

866 TUBES 99c

Isolantite tops — Heavy duty rectifiers.

ANOTHER SPECIAL BUY!!!
These also carry our full guarantee
Only Six to a Customer

THORDARSON CASED TRANSFORMER

600 volts each side of C.T. 200 MA 2 1/2 V. 10 amps. C.T., 5 V. 3 amps. 7 1/2 V. 3 amps. C.T. \$2.45
THORD. CHOKE 12 H 250 MA. \$1.95

NEW! HAMMARLUND SUPER PRO

Complete with tubes. \$198
as above, with crystal. \$216
Less 2% for Cash

THE NEW PATTERSON PR16 RECEIVER

PR16C In Metal Cabinet complete with Tubes, Speaker and Crystal. \$95.70
PR16 same as above without crystal. \$89.70

HALLCRAFTERS SUPER-SKYRIDER

Complete with 9 Metal Tubes. \$79.50
Same as above. With Crystal. \$89.50
See Technical Article P. 36 Aug. QST.

PREPAID ANYWHERE IN U.S.A.

NATURAL BAKELITE 6" SPREADERS

10c, 10 for 90c

SOLID ENAMELED ANTENNA WIRE

No. 14 (any length) per 100 ft. \$.35
No. 12 (any length) per 100 ft. \$.55
No. 10 (any length) per 100 ft. \$.90
No. 8 (any length) per 100 ft. \$ 1.30

Hard Drawn Tinned Copper Antenna Wire

No. 12 (any length) per 100 ft. \$.55
No. 14 (any length) per 100 ft. \$.35

GROSS CASED POWER TRANSFORMERS

650 v. ea. side C.T. 350 ma. fila. 2-7 1/2 v C.T. and 1-5 v will give 500 v with choke input using 83 or 523 tubes. You can run your entire R.F. and class B off this trans. \$5.50
750 v. ea. side C.T. 300 ma. fila. 2-7 1/2 v C.T. and 1-5 v. \$5.65
750-1000 v. ea. side of C.T. 300 watts. \$6.65
850-1350-1500 v. ea. side of C.T. 400 watts. \$8.75
(the ideal job to give 750-1000-1250 v D.C. with choke input)
850-1350-1500 v. ea. side of C.T. 550 ma. \$12.50
1500-2000 v. ea. side of C.T. 800 watts. \$11.70

NEW!! HOYT BAKELITE CASE HOT WIRE ANTENNA METER

3 1/2" Across Flange, Mounts through 2 1/2" hole. Scale Length 1 3/4". Ranges: 0/1.5; 0/3; 0/5 Amps. \$3.50

BARR DB3 TRANSCEIVER

less tubes, batteries and accessories. Bulletin on re- \$16.20
quest.

KEYING RELAY

will operate on one dry cell. Can be used as Single Pole Single Throw or Single Pole Double Throw. Sturdy construction, has 1/2" diameter Solid Silver Contacts. Compares favorably with expensive types. Special 59c



DELUXE DIALS AND FLUTED KNOBS

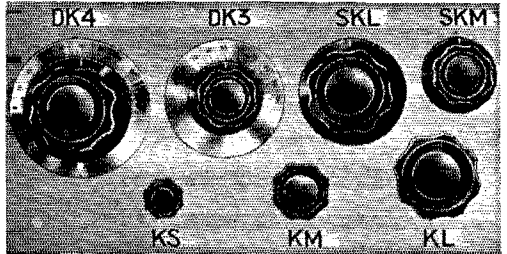

These are the trimmings you have noticed of late on the finest equipment, now available at these prices. Dial plates made of circular finished solid nickel silver, not plated brass or aluminum. Fluted knobs are finest quality genuine bakelite. DK-3. 3 1/2" Dial and Knob. \$.70
DK-4. 4" Dial and Knob. \$.85
SKM. Medium 2" Knob with skirt. \$.27
SKL. Large 3" Knob with skirt. \$.36
KS. Small Knob. \$.15
KM. Medium Knob. \$.21
KL. Large Knob. \$.27

THORDARSON

EVERYTHING in this high grade line in stock
Write for catalogue

EIMAC UNSURPASSED TRANSMITTING TUBES!

50-T Output 75 to 250 watts. \$13.50
150-T Output 150 to 450 watts. 24.50

CASED FILAMENT TRANSFORMERS FOR EIMAC TUBES

Cased 5 volts CT 12 Amps. \$2.95
Cased 5 volts CT 20 Amps. 4.95

UNIVERSAL ANTENNA COUPLING SYSTEM INDUCTANCES

Wound on threaded double X natural bakelite tubing, can easily be tapped, with clip supplied, ea. \$1.50
(Use one coil for single-wire feed and two coils for two-wire systems)

Low C 80-160 Meter Amplifier Coils

(See transmitter by GRAMMER page 46 May QST) Plug-in, wound on threaded natural bakelite tubing, will tune with 50 or 60 mmf. condenser, any size, each. \$1.50
40-Meter Type. 1.00

GUARANTEED TUBES ISOLANTITE TOPS

800 Carbon Plate. \$4.90
866-A 10,000 volts inverse Peak. \$1.85
203-A Carbon Plate. \$8.45

20% DEPOSIT WITH ALL C. O. D. ORDERS

REMIT BY M. O. INCLUDE POSTAGE

Cable Address: GROSSINC

GROSS RADIO, INC., 51 VESEY STREET, NEW YORK CITY



If all the copies of QST were put end to end—

but why put 'em that way? Why don't you put yours side by side in a nice *QST* binder. Then your *QST* file looks like what it really is — a library of the best radio amateur dope in the world. Twelve copies, and the yearly index go in each binder. Then your copies of *QST* are where you want them — when you want them. A sturdy binder finished in rich, wine colored, Du Pont Fabrikoid. Waterproof, oilproof, wearproof, troubleproof, 100 proof.

\$1.50 each, postpaid

(One set of yearly labels (1919-1938) now provided with each binder)

American Radio Relay League

West Hartford

Connecticut

amperes or more when C_2 is off resonance, assuming an amplifier plate voltage of 1000. With C_2 at resonance, increase the capacity of C_3 and C_4 simultaneously. As the antenna tuning approaches resonance the antenna current will rise, and with it the plate current. When the plate current reaches the normal value—150 ma.—it will probably be necessary to retune C_2 slightly, since the antenna circuit affects the plate-tank tuning to some extent. The object of tuning, of course, is to obtain maximum antenna current consistent with the plate-current rating of the tube. If, when maximum antenna current is obtained, it is not possible to make the tube draw as much as 150 ma. with C_2 at the resonance or the minimum plate-current setting, the coupling is too loose. It may be tightened by increasing the number of turns between taps on L_3 . Two turns should be sufficient, however. With 45-foot feeders the two antenna condensers probably will be at about one-fifth of full scale for resonance at 7 mc., assuming an antenna in the vicinity of 66 feet long.

For 14-mc. work the taps on L_2 should be set three turns in from each end, in which case the band will be found with C_2 near minimum capacity. The neutralizing condenser setting should not be touched. Resonance will be indicated by a plate-current dip just as on 7 mc., although the minimum plate current with taps disconnected from L_3 will not be as low as on 7 mc., running in the vicinity of 50 ma. on 14 mc. as compared with about 10 ma. on 7 mc. Make certain that the harmonic picked out actually is the second; it is not beyond the bounds of possibility that a higher harmonic will be hit upon at the first attempt, especially if the tank-circuit dimensions are not followed closely. The antenna can be coupled and tuned in just the same way as on 7 mc. With the same feeder length the antenna condensers will be set at about half scale for resonance on 14 mc.

FINIS

In the end, the transmitter tuned out to do the job that had been intended. Essentially designed to occupy a small space, give a fair amount of power output, and be convenient to operate, it has proved to be satisfactory on all three counts. The power output at normal tube input is in the vicinity of 100 watts on 7 mc. and 50 watts on 14 mc.—fair enough under the circumstances, since no particular attempt was made to attain high efficiency. Band changing is simply a matter of putting three dials on predetermined settings and attaching or disconnecting two clips, a procedure which takes but a few seconds. The break-in feature is decidedly advantageous. Key-clicks are negligible, and can be eliminated entirely with a simple thump filter.

The moral, if any is to be drawn, is perhaps that paper circuits and actual circuits easily can be two entirely different breeds of animals. Even such a simple rig as this one can have its knotty points. If any one feels the urge to build one "just like *QST* except . . ." we strongly recommend that some heavy thinking be done about the exceptions. Otherwise the consequences are not our responsibility.

DOUBLY CHECKED *and* DOUBLY PROVED

ACR-136

\$69.50 F. O. B.
FACTORY

complete with tubes, power supply, speaker, entirely self-contained in metal cabinet; nothing else to buy.

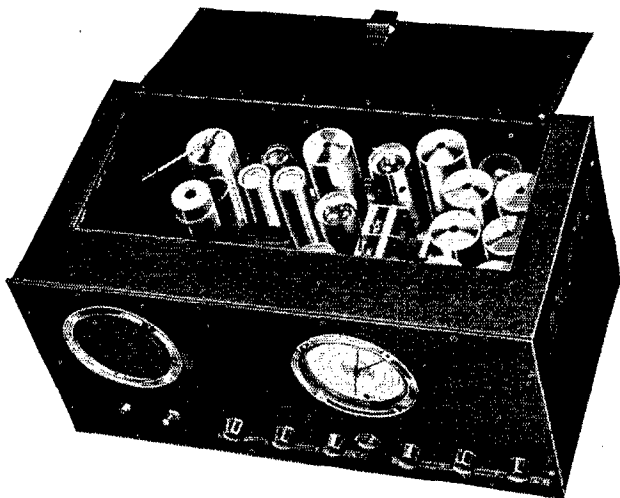

THE first check on the ACR-136 is in the factory, where each one produced is tested by an amateur who is just as particular about performance as you are yourself. His O. K. on the ACR-136 is like the W. A. C. to you—a fine tribute to a swell job.

The second check is in the field. This remarkable instrument has been out long enough now to have proved itself up. You'll find it being mentioned more and more often on QSL's. You'll hear amateurs refer

to it in their contacts. It's a great buy, such as only the RCA factory could turn out. Send for folder.

**Economical
V-Cut
Crystal**

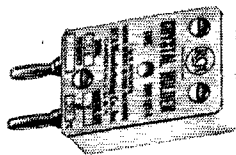

Don't let the price worry you. With this entirely new V-cut you get a frequency stability of 2 cycles or less per million per degree centigrade, without using an expensive oven. Calibrated accuracy, 0.005%. Available for 3.5 to 4 MC. band within plus or minus 5 KCS. of requested frequency, or from stock. Complete with special ceramic holder, \$12. Holder alone (FB with other crystals, too) \$2.50. Send for folder.



AMATEUR RADIO SECTION

RCA VICTOR DIVISION

RCA Manufacturing Company, Inc.

Camden

New Jersey

NEW!—A practical book

to help you pass examinations for all classes of radio operator licenses.

Epecially Adapted for Home Study

Here is the book for the experienced operator or station technician who wants to advance to a better job. It is equally suited for the man just entering this field, who wants to take up essential, authoritative preparation for a license in any branch of practical radio operating.

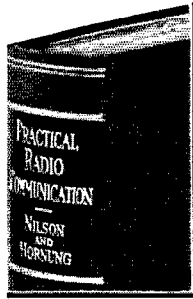

Just Published

PRACTICAL RADIO COMMUNICATION

Principles — Systems — Equipment—Operation Including Short-wave and Ultra-short-wave Radio

744 pages, 4 x 7, over 400 illustrations, \$5.00

By Nilson and Hornung, well-known radio experts, instructors, writers. This book covers the requirements for ALL CLASSES of radio operator's license examinations, treats long, medium, short, and ultra-short wave radio, includes ALL CLASSES of radio stations — is in general a complete text on practical radio communication based on a theoretical introduction.

What this book gives you

- full treatment radio and electrical principles; delves deeply into alternating currents.
- particular attention to broadcasting; Western Electric broadcast transmitter; studio acoustics and apparatus, control-room equipment and operation; special diagrams, etc.
- section on ultra-short-wave equipments, for police operators.
- radio-telegraphic and radio-telephonic treatment aviation radio; aircraft transmitters, receivers, direction-finding equipment; testing and maintenance.
- marine medium-frequency equipment, high-frequency transmitters and receivers; Coast guard low-power transmitters; direction-finders, etc.
- power-supply apparatus; rectifiers; generators; batteries, etc.

Many other helpful facts given. Clear, concise, well-illustrated style. New features of arrangement. Complete, practical, authoritative. Use this book to get ahead in radio operating.

See it for 10 days without obligation

Send This McGraw-Hill On-Approval Coupon

McGraw-Hill Book Co., Inc., 330 W. 42nd St., N. Y. C.

Send me Nilson and Hornung's Practical Radio Communication for 10 days' examination on approval. In 10 days I will send \$5.00, plus few cents postage, or return book postpaid. (Postage paid on orders accompanied by remittance.)

Name

Address

City and State

Position

Company QST-10-35

(Books sent on approval in U. S. and Canada only.)

Reducing QRM on 56 Mc.

(Continued from page 30)

Excitation should be on and amplifier plate voltage should be off when this is done, of course.

This transmitter has been copied by a number of the local hams and all have obtained very satisfactory results.

Having procured some Raytheon Type RK-34 tubes, it was decided to build another transmitter using these tubes in the same circuit as before. A novel arrangement was used, the completed transmitter being shown in the photograph. The grid leak of the amplifier was 3000 ohms, instead of 1500 as shown in the original circuit diagram. At first, a very strong parasitic oscillation was present in the amplifier even with no excitation from the oscillator. This was produced by the plate and grid leads forming a t.p.t.g. circuit at a frequency well below two meters. A flashlight bulb could be lighted brightly by laying it on one of the plate leads. These parasitics were easily killed by installing small grid chokes in both the oscillator and amplifier grid leads. The tube is very efficient at 56 megacycles. A dip in plate current was obtained from 140 ma. off resonance down to 34 ma. in resonance, and one-quarter-inch arcs could be drawn off the plates of this tube with a pencil. At first, this layout was rather unstable. A big improvement in stability was obtained by using separate filament supplies to the two heaters, although this transmitter was never quite as stable as the 53 layout.

Later, the RK34 oscillator was discarded and the second 53 of the original transmitter was link-coupled into the grid tank coil of the RK34 as the modulated amplifier. This gave a buffer stage and, due to the gain through this buffer, the input to the 53 oscillator could be cut down so that absolutely no drift could be noticed and the frequency modulation was reduced to a fraction of a kilocycle. This layout is now operated crystal controlled by substituting the 53 universal exciter for the master oscillator, using link coupling to the buffer, and now operates in this manner as the final form of this transmitter.

This transmitter has also been operated crystal controlled on ten and twenty meters. During about two weeks, nine W9's, two W8's and two W4's were QSO'd on 28 megacycles using 'phone in all but two cases. Very good reports were received. This transmitter has also been used on 14 megacycles, using both c.w. and 'phone. A flock of W6's and a few Europeans were QSO'd during the limited time that the transmitter was operated on that band.

It is not expected that the transmitters here described are the final word but they have produced very satisfactory results. They will serve very nicely as a basis for more extensive and pretentious experiment by the five-meter fraternity. It is hoped that the gang will see the advantage of putting this type of apparatus into operation and that soon the majority of five-meter transmitters will be able to stand on a par with those used on our lower frequency 'phone bands.

NORTHERN OHIO LABORATORIES

**THIS MONTH'S SPECIAL
ALL FOR \$7.49**

Two heavy duty 866's
Two sockets and clips
Filament tran. heavy duty
Heavy duty 250 MA Filter choke

| | |
|-----------------------|---|
| New Mac-Key \$7.95 | CARDWELL 157 B Split Stator Condenser \$4.80 |
|-----------------------|---|

THORDARSON T6411
1250-1550 Each Side c.t.
520 v.a. \$13.80

| | |
|---|----------------------|
| RAYTHEON RK20.....\$15.00 RK18..... 10.95 RK23..... 5.95 | NAVY KNOBS 25c |
|---|----------------------|



500 W. RADIOSTATS...\$6.00

RELAY RACK PANELS
CRACKLE FINISH T.M. TYPE

| | |
|---------------|----------|
| 19" x 7" |48c |
| 19" x 8 3/4" |58c |
| 19" x 9 1/2" |63c |
| 19" x 10 1/2" |69c |

RCA ACR-136
\$69.50

**OHIO AMATEURS BUY AT
NORTHERN OHIO LABORATORIES**

Watch for our ad each month in QST
A convenient and well established organization to serve you well. Quality and guaranteed laboratory approved ham parts.

Branches in following Ohio cities—
CAMBRIDGE, SHELBY AND SPRINGFIELD

You Can't Work 'Em If You Can't Hear 'Em
— THE ANSWER —

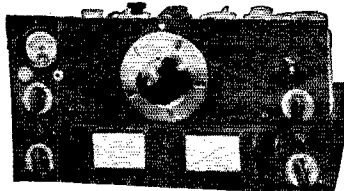

NATIONAL HRO IN STOCK
IMMEDIATE DELIVERY

NATIONAL RECEIVERS

— IN STOCK —

| | | | | |
|---------|---------|---------|---------|----------|
| FB7A | FBXA | ACSW3 | SRR | AGSX |
| \$37.50 | \$51.90 | \$19.50 | \$19.50 | \$123.00 |



**RCA
IN STOCK**

| | |
|-----------|---------|
| 800..... | \$10.00 |
| 801..... | 4.50 |
| 802..... | 3.90 |
| 203A..... | 17.50 |
| 838..... | 18.00 |
| 841..... | 3.25 |
| 866A..... | 5.00 |
| 852..... | 23.80 |
| 860..... | 35.00 |
| 865..... | 12.75 |

G.E. Pyranol Condensers
G.E. Panel Meters

| | |
|--|----------------------|
| EIMAC 50-T \$13.50 150-T \$24.50 | WHAT'S A MUGAWUG? |
|--|----------------------|

| | |
|-------------------------|---------|
| National R-100 RF Choke | 45c |
| TMC 100D S.T. Cond. | \$4.50 |
| R-152 H. Duty RF Choke | \$1.35 |
| AB 5897 Power Pack | \$15.90 |

FILTER CONDENSERS
W8BAH SPECIALS

| | |
|---------------------------|--------|
| 2 mfd. 1000v working..... | \$1.98 |
| 2 mfd. 1500v working..... | 3.00 |
| 2 mfd. 2000v working..... | 3.90 |

GORDON NAME PLATES
10c EACH

CLASS A MODULATOR

NORTHERN OHIO LABORATORIES
2073 WEST 85th STREET, CLEVELAND, OHIO

HAMMARLUND
NEW SUPER-PRO

INSTRUCTOGRAPH

**THE PRACTICAL
CODE TEACHER**



To learn the code or to increase your speed, the practical way is to have your own Instructograph. Book of Instructions, written by an expert operator, shows you how to study to best advantage; and you practice at home, at whatever time suits you best — no waiting for code schedules, no interference to annoy you. Instructograph sends perfect code, at the speed you want, fast or slow.

You can buy or rent an Instructograph. Terms are very reasonable; rental may be applied on purchase price. Transportation charges paid to all parts of the U.S.A. Extra perforated tapes sold separately, if desired. Write TODAY for descriptive folder and price list. There's no obligation.

INSTRUCTOGRAPH COMPANY—Dept. Q10
912 Lakeside Place Chicago, Illinois

Representatives for Canada

RADIO COLLEGE OF CANADA, LTD., 863 BAY ST., TORONTO

**"I'M A BOON TO THE
HAM" says EMANUEL ESICO**

AT LAST — a soldering iron upon which the amateur can depend!
Esico copper tips, forged by a special process, prevent quick oxidation.

Esico elements, wound with Nichrome V, assure a constant soldering heat at the tip. Minimized oxidation resulting from use of Nichrome V guarantees full wattage rating throughout its long life.

ELECTRIC SOLDERING IRON CO., INC.
342 West 14th Street, New York, N. Y.

ESICO
REG. U.S. PAT. OFF.

Esico irons as low as 66c at authorized Esico Distributors.



**Complete Designs of
20 Transmitters**

12 tested transmitter R.F. section designs! 8 modulator and speech amplifier designs!

Outputs ranging from a little fellow on which the O.W. can learn, to big ones comparing in every way with the best broadcaster.

Circuit, and complete parts specifications of transformers, inductances, and all other component parts.

One of the most complete and thorough handbooks on transmitter design ever printed!

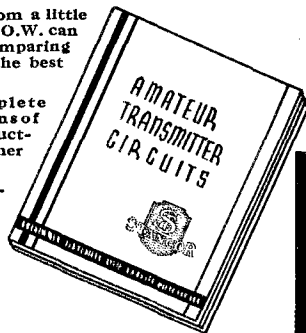

FREE!

VALUABLE REFERENCE BOOK

This advertisement and 12¢ IN STAMPS, to cover mailing expenses, will bring your FREE copy of this valuable Reference Book. There is no obligation.

Standard Transformer Corp.
856 Blackhawk St., CHICAGO, ILL.



The Sixth Edition
OF THE
**LICENSE
MANUAL**
WITH THE
FOLLOWING CHANGES

★ Corrected text of the amateur regulations up to date, including latest amendments.

★ Corrected answers to all the representative examination questions relating to regulations, where the same are changed by recent amendments to regulations.

★ Corrections in the text concerning permissible 'phone bands and portable privileges, as have been amended by these changes.

★ Additions to the text about licensing, to incorporate the existing arrangements in Alaska, Puerto Rico and Hawaii, the right to have code tests administered by government radiotelegraph operators; and a similar paragraph extending to cripples the right to have their material dictated or typewritten.

★ Several notable changes in the way of improved answers to sample questions in the Class-A 'phone examination, bringing them in line with the modern engineering concept of modulation.

★ Several other improved answers to typical questions appearing in the Class-B-C examinations.

IT LEAVES THE JOB COMPLETELY UP TO DATE IN EVERY RESPECT.

VALUABLE ALIKE TO THE BEGINNER AND THE ALREADY-LICENSED.

25 Cents Postpaid

(No stamps, please)

The . . .
**AMERICAN RADIO
RELAY LEAGUE**

West Hartford, Connecticut

(No. 9 in the series
entitled The Radio
Amateur's Library)

A Homemade World Time Clock

(Continued from page 45)

quickly traced and later filled in with black India ink. On completion of the layout of the face, it was cemented to a level piece of heavy tin with rubber cement. The face should be made as large as the clockworks will permit so that the time zone indicators will be large enough to be read conveniently.

Then a disc bearing 24 pointers was jig-sawed from light sheet aluminum. Since my clock has a small seconds dial between 24 o'clock and the center of the face, it was necessary to make the pointers short enough so that they did not entirely obscure the seconds dial. In the ordinary type of clock without the small dial, the pointers should be made nearly as long as the hour hand. These pointers were lettered with black India ink to indicate time zones as follows: Starting with local time, in my case Pacific Time, and reading in a clockwise direction, *Seattle; Denver; Chicago and Central America; New York and Lima; Halifax and Buenos Aires; Greenland and Rio de Janeiro*; then a blank pointer; *Iceland; Greenwich* (pointer tipped with red lacquer); *Berlin and Rome; Cairo and Durban; Bagdad and Madagascar*; then another blank; *Bombay; Calcutta; Singapore; West Australia, Nanking and Manila; Osaka and Central Australia; Hobart and Sydney; New Caledonia; Wellington* (subtract 30 minutes); *Aleutian Peninsula; Seward and Hawaii* (subtract 30 minutes); *Sitka and Yukon*; and that brings us back to Seattle again. The pointers for Wellington and Hawaii could have been offset to show exact time there, but that would have spoiled the symmetry of the pointer disc, so a little mental calculation is necessary for these.

The disc of pointers was riveted to the hour hand so that the local time pointer coincides with the hour hand, and so the pointers revolve with the hour hand. Thus the various pointers indicate the hour in their respective time zones, while the minute hand shows the minutes as usual. Light dotted lines were extended from the center of the dial to each hour to aid the eyes from pointer to hour.

To avoid confusion each of the 24 hours is marked with a small rectangle at the border of the face, and the even hours, which indicate 5, 10, 15 minutes, etc., are marked with small triangles.

Practically any type of clock can be adapted to this use if the proper gears are at hand or may be obtained. However, the movement should be of as high quality as possible, for it would be a waste of time to put so much work on an inferior article. Your local watchmaker can help you in getting the gears. Those who build a clock of this type will find it most useful and an immediate point of interest to all visitors to the shack.

Strays

Heard W9SEX calling CQ. Is that "sex appeal?"—W9BSX.

FAR IN ADVANCE

The Bliley LD-2 Crystal Unit brings a new standard of crystal efficiency to the amateur bands at the exceedingly low price of \$4.80.

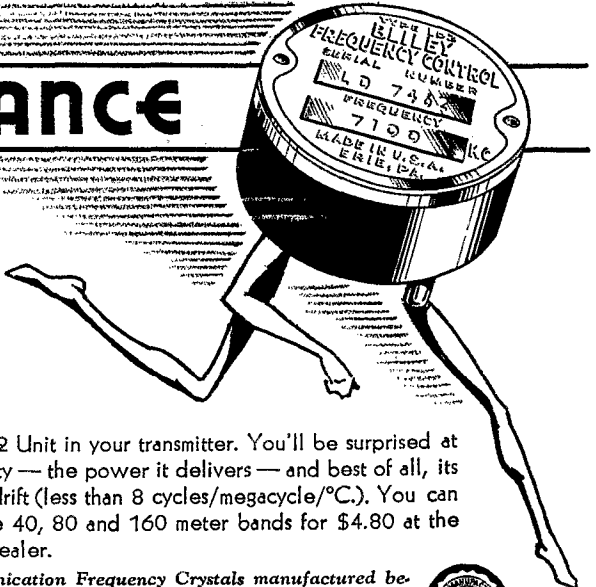

Try a Bliley LD-2 Unit in your transmitter. You'll be surprised at its greater activity — the power it delivers — and best of all, its low frequency drift (less than 8 cycles/megacycle/°C.). You can get them for the 40, 80 and 160 meter bands for \$4.80 at the nearest Bliley dealer.

General Communication Frequency Crystals manufactured between 20Kc and 15Mc. Write for Bulletin G-6

BLILEY ELECTRIC CO., ERIE, PA.

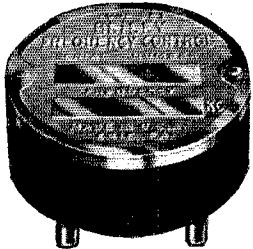

BLILEY LD-2 CRYSTAL UNIT

IMMEDIATE DELIVERY FROM RECEIVER HEADQUARTERS

NATIONAL HROs. \$167.70
RME9Ds. 112.50
RCA AGR-136s complete. 69.50
BRETTING 12s complete prepaid. 93.00
SILVER 5Ds complete prepaid. 109.80
S-9 SUPER SKYRIDERS prepaid. 79.50
SUPER PROs complete (when available). 194.03
PR-16s complete prepaid (when available). 89.70
ALL COLLINS transmitters at lowest prices.
RCA, TAYLOR, EIMAC transmitting tubes at lowest prices.

TRADE IN YOUR RECEIVER OR TRANSMITTER
Consider these reasons why it is genuinely to your benefit to send a trial order to W9ARA. I sell exclusively to amateurs and am jobber for every line. Besides guaranteeing to sell to you at lowest wholesale prices and to see that you are entirely satisfied with everything you buy from me, I take in trade your used apparatus and furnish technical advice free. I sell on time payments. Write to W9ARA about any apparatus.

HENRY RADIO SHOP

211-215 North Main St. Butler, Missouri

MICA TRANSMITTING CAPACITORS



Heavy-duty units . . . 1000, 2500 and 5000-volt ratings . . . all standard capacity values. Selected mica and foil . . . thorough impregnation . . . sealed in molded bakelite casing. Insulated mounting holes and terminals for individual connections and group stacking. And priced right!

DATA Send for latest catalog covering complete condenser and resistor line. Also sample copy of Research Worker.



CORPORATION
73 Washington St. Brooklyn, N. Y.

HIGH FIDELITY* Coto TRANSFORMERS

for Eimac — Taylor — RCA838 Tubes

*Flat frequency response from 50-9000 cycles

| Type | Tubes | Class B Output to | Audio Pow. Watts | Wgt. Lbs. | List Price |
|--------|-----------------|-------------------|------------------|-----------|------------|
| CI-411 | RCA838's | 2500-10000 ohms | 200-260 | 34 | 28.00 |
| CI-412 | Taylor HD203A's | 3500-6250 ohms | 500 | 45 | 45.00 |
| CI-413 | Eimac 50T's | 10000 ohms | 200 | 34 | 28.00 |
| CI-414 | Eimac 150T's | 4000-6250 ohms | 500-750 | 48 | 50.00 |

Sold through reputable dealers everywhere at usual amateur discount

COTO-COIL COMPANY

229 Chapman Street
Providence, R. I.

4214 Country Club Drive
Long Beach, Calif.

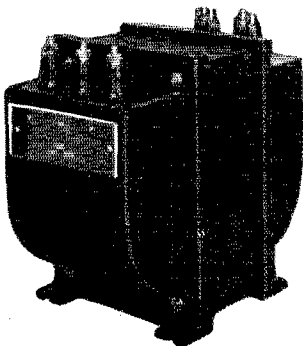

The Most Useful Gadget You Ever Owned!

To give you the answers to questions like these—

- HOW MANY TURNS?
- HOW BIG A CONDENSER?
- WHAT SIZE WIRE?
- WHAT DIAMETER COIL-FORM?
- HOW MANY MICROMIKES?
- WHAT FREQUENCY RANGE?
- WHAT SHAPE OF COIL?
- HOW MANY MICROHENRIES?
- WHAT SPACING BETWEEN TURNS?
- WHAT WAVELENGTH?
- HOW LONG A COIL?
- HOW MANY TURNS PER INCH?

It is for solution of problems involving frequency, inductance and capacity, in design of radio frequency circuits from high-powered transmitters to simple receivers. Gives direct reading answers for size of coils and condensers for any frequency or range between 400 Kc. and 150 mc.

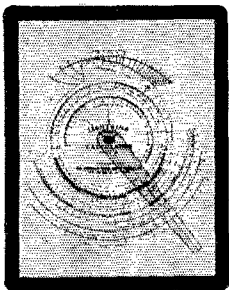

THE LIGHTNING Radio Calculator

(Type A—please specify type when ordering)

Postpaid **\$1.00** anywhere

AMERICAN RADIO RELAY LEAGUE
WEST HARTFORD, CONNECTICUT

With the Affiliated Clubs

(Continued from page 37)

entire program. A turkey dinner left nothing to be desired in the way of "eats." There were four rows of tables, each row decorated in colors representative of these organizations: A.R.R.L. (black and yellow), B.E.R.U. (red and yellow), Alberta Radio Experimenters Association (green and yellow), Calgary Amateur Radio Association (blue and yellow).

Three hundred and eighty amateurs, their YF's and YL's, gathered at Exposition Park, Aurora, Ill., on August 4th to participate in the Eighth Annual Convention of the Fox River Radio League. The highlights of the program were a talk by Central Division Director E. A. Roberts, W8HC, and the banquet, which was followed by "amateur night" entertainment, the prize drawing and the grand finale—dancing. To the following club officers and committee members is due the credit for the success of this affair: W9CFQ, W9BLT, W9NE, W9EDW, W9JIC, W9ALZ, W9IUX, W9RNV, W9EBA, W9RMC.

The Sheboygan (Wis.) Radio Amateur Club and the Fond du Lac (Wis.) Amateur Radio Club were hosts to one hundred and forty-seven amateurs at the third annual outdoor QSO Party of the Fox River Valley affiliated clubs on June 16th. The committee responsible for a fine program included W9JCV, W9JDP, W9ERS, W9GAF, W9NVJ, W9NSM, W9DJA, W9FTH, W9POJ, W9KTK and W9AUV.

Miscellany

The Tri-States Radio Club of Port Jervis, N. Y., is building a new club house in Montague, N. J. Two 90-foot poles will be erected. The club is also assembling an emergency station. . . . The Heart of America Radio Club, Kansas City, Mo., conducted a hidden transmitter hunt during July. This hunt was the peak of summer activity in that area. . . . The Oakland (Calif.) Radio Club finances A.R.R.L. memberships for its members at the rate of 50¢ down and 50¢ per month. The club finds this works well in maintaining a high percentage of league memberships. . . . The second annual outing of the Intercity Amateur Radio Club of Newark, N. J., was held June 30th. Two stations were in operation at this affair: W2GYR, the club's station, portable on 3.5 mc., and W2FSQ, a 56-mc. portable-mobile rig. Among those present were W2CBF FAD GBY FDL IDR ILS FYK EWM FTP EKV FZB FSQ HFB. . . . The Island Radio Club of Bar Harbor, Maine, is resuming regular meetings October 1st. . . . Included in the accomplishments of the Wichita (Kansas) Amateur Radio Club is the gathering of evidence which led to the closing of several unlicensed stations. . . . The Fort Worth (Texas) Radio Club is making arrangements to send code lessons on the 1.75-mc. band. . . .

Visit the Clubs

At A.R.R.L. headquarters there are recorded the addresses of the several hundred amateur

Why You Will Want G-E Instruments

BECAUSE their sturdy construction and large clearances mean extra-long life for the instrument.

BECAUSE their neat, well-balanced appearance will add to the attractiveness of your transmitter.

BECAUSE you can be assured of high quality and dependable operation.

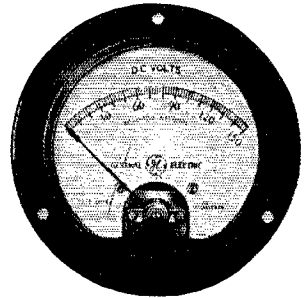

ASK to see these new G-E instruments at your jobber's or radio dealer's. We will gladly send you a copy of our bulletin, **SMALL PANEL INSTRUMENTS, GEA-1239B**, on request. Radio Department, General Electric, Schenectady, N. Y.

430-54

GENERAL ELECTRIC

HIPOWER

Thick cut, low drift "AH" cut crystals are from 2 to 40 times as stable as X or Y cuts.

"AH" FOR STABILITY, ACTIVITY
ORDER FROM YOUR DEALER—*or direct*

Crystals supplied within 10 Kc. of specified frequency or choice of dealer's stock.

1700-3500 Kc. 7000-7300 Kc.

| | | |
|--------------|--------|--------|
| "AH" 10..... | \$2.35 | \$3.90 |
| "AH" 5..... | 3.90 | 5.90 |
| "AH" 2..... | 8.90 | 12.90 |

The number following "AH" is the drift in cycles per °C. per 1000 Kc.

WRITE FOR HIPOWER DEPUZZLER SHEET **IT'S FREE**

HIPOWER CRYSTAL CO., 2035 W. Charleston St., Chicago, Ill.

BE UP--TO--THE--MINUTE!

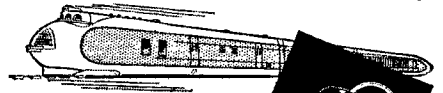

**USE
SPRAGUE
Short Wave
HIGH FREQUENCY
BY-PASS
CONDENSERS**

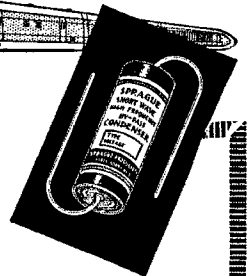

The Ideal Mica Replacement—Oil Impregnated

IF YOU HAVEN'T TRIED these popular Sprague units, you're missing a real treat! Guaranteed as excellent mica substitutes for Short Wave by-passing and many other uses. Smaller than mica — cost far less — and you can't break them down. Metal encased, non-inductive, low power factor, oil impregnated, 1500 V. and 1000 V. continuous D. C. rating. See them at your jobbers or write for complete "600" Line catalog including famous Sprague Oil Transmitting Condensers. Ask for **FREE BOOKLET "Condenser Facts."** SPRAGUE PRODUCTS CO., North Adams, Mass.

SPRAGUE CONDENSERS

SPRAGUE
600 LINE

★ AMERICAN ★ DRILL PRESS

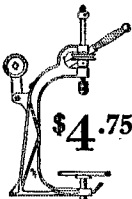

\$4.75

Heavy, powerful press equal in capacity and accuracy to others selling for three times as much. Frame and table heavy grey-iron castings, accurately machined. 3" spindle-travel; chuck to table 7½"; drills to center of 8" circle; belt-tension adjustment; 9/32" capacity chuck furnished, will take ½" chuck also; bridge-truss construction; send \$1, balance COD. FOB N. Y. Send FOR BIG FREE CATALOG complete line remarkable low-priced tool values, also free project sheets.

AMERICAN POWER TOOL CORPORATION

30 Fourth Avenue Dept. DQ New York, N. Y.

THE LIGHTNING OHM'S LAW Calculator

(Type B)

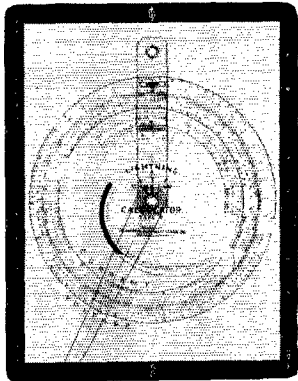

- ✓ Quick
- ✓ Direct
- ✓ Versatile
- ✓ Simple

Gives direct-reading answers to practical calculations involving current, resistance, voltage and power, with scales for resistance of copper wire and additional supplemental scale for calculating decibel gain or loss. Answers three separate kinds of problems: Finding value of current, voltage, power or resistance, when any two are known; finding resistance or voltage drop in any wire or circuit or resistor; finding decibel gain or loss in amplifiers or circuits. Accurate within commercial resistor tolerances.

(Please specify Type B when ordering)

\$1.00 postpaid
anywhere

AMERICAN RADIO RELAY LEAGUE
WEST HARTFORD, CONNECTICUT

radio clubs affiliated with the League, their places and times of meetings. Clubs are splendid places to get acquainted with other amateurs and to participate in interesting discussions on amateur radio. Why not drop in at your local club and "meet the gang"? Address the Communications Manager (enclosing 3¢ stamp, please) for data on affiliated clubs in your vicinity.

—E. L. B.

Modulated Emissions from WWV

(Continued from page 47)

given by voice and include the station call letters and a statement of the carrier frequency and the audio modulation frequency.

Except during the announcements, the c.w. emissions consist of continuous, unkeyed carrier frequency, giving a continuous beat note in the telephone receiver in heterodyne reception. The radiated power in the c.w. emissions is 20 kilowatts.

The modulated emissions, except during the voice announcements at the beginning of the hour, consist of an uninterrupted audio frequency superposed on the carrier frequency. The radiated power is only 1 kilowatt; reception is, therefore, not as reliable as for the c.w. emissions of Tuesdays and Fridays; it is hoped to increase the power later. The modulated emissions are somewhat experimental, and for this reason an audio frequency other than 1000 cycles per second may be used on some occasions. The presence of the audio modulation frequency does not impair the use of the carrier frequency as a standard to the same high accuracy as in the c.w. emissions.

The accuracy of the frequencies as sent out from the transmitting station is at all times better than a part in five million. Transmission effects in the medium (Doppler effect, fading, etc.) sometimes result in slight fluctuations in the frequency as received at a particular place. However, these practically never impair the reception of the carrier frequency to the accuracy stated. Under some conditions, momentary fluctuations as great as 1 cycle per second may occur in the modulation frequency. It is generally possible, however, to use the modulation frequency with an accuracy better than a part in a million by selecting that one of the three carrier frequencies which has the least fading. It is helpful to use automatic volume control on the audio frequency emissions.

Information on how to receive and utilize the standard frequency service is given in a pamphlet obtainable on request addressed to the National Bureau of Standards, Washington, D. C. From any single frequency, using harmonic methods, any frequency may be checked.

The Bureau welcomes reports of use and comments upon the standard frequency service. As the modulated emissions are somewhat experimental, it is particularly desired that users report to the Bureau their experience in using them, including: description of method of use;

KENCO JR. SEMI-AUTOMATIC KEY

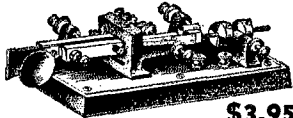

AN UNUSUAL VALUE
Not Many Left

\$3.95

INTERNATIONAL PLATE TRANSFORMERS

We recommend these companion transformers as representing real value—quality has not been sacrificed—rather the volume increased greatly to make possible these low prices. Fully cased in black crystal finish steel.

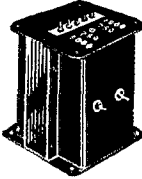

Model 2000-750-1000 V, each side center tap, 300 M..... **\$5.95**

Model 3000-750-1000-1500 V, each side center tap, 300 M..... **\$8.95**

10V — 6.5A filament transformers for 2-203A, fully cased..... **\$2.10**

Resonant Filter Choke will handle 1KW..... **\$3.60**

The MAC-KEY The HARVEY
Improve your **\$7.95** CT60 band-switching
sending unit. Uses single RK20..... **\$33.00**

Astatic Crystal Mike..... **\$13.50**
CARDWELL Condensers — Complete line in stock. Your discount 40%.

THE RADIO SHACK

OFFERS the most complete selection of amateur equipment in New England and the kind of service the amateurs like.

PYRANOL

2 MFD. 2000-VOLT
FILTER CONDENSERS

Guaranteed 2 Years
Unconditionally

Not one has blown in service over the last 18 months and we KNOW that many are being used consistently on voltages 200% in excess of their rating. Don't take our word for it. Ask the ham that owns some. **\$2.90**



VT203A—
Graphite..... **\$9.00**

Johnson 50-watt
socket..... **\$1.20**

15H — 250-mill
choke (cased) **\$2.50**

30H — 125-mill
choke..... **.95c**

THORDARSON: 600-0-600V
— 200 mills; 2.5V — 10A — **\$2.75**
7.5V — 3A; 5V — 3A.....

JOHNSON 5M. Q
Ant. **\$3.90**
Birnbach 5 M
antenna..... **\$1.50**

RAYTHEON
RK20 **\$15.00**
RK23 **4.50**
RK28 **38.50**

Mail Orders Filled. Send M. O.

THE RADIO SHACK

46 Brattle St., Boston, Mass.

INTERNATIONAL CRYSTAL HOLDER

Designed to rigid specifications, Chrome top plate serving as the top electrode is held on by cap nuts — holds crystals up to one inch square. Plugs into 5-6 pr. socket or GR plugs by slight springing of prongs **85c**

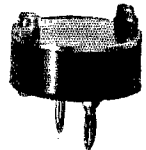

TOBE AMATEUR COMMUNICATION RECEIVERS



More band spread — less noise. 160-80-40 — 20M amateur bands. No plug-in coils. 1 micro-volt sensitivity or better on all bands. Single tuning control. Space does not permit an adequate description. Write or drop in to see this receiver. **\$41.40**
Unwired.....

Baldwin Type C phones..... **\$2.50**

Triplet 0-25 to 500 mill 3 1/4" Bakelite case d.c..... **\$3.75**

Heavy Duty 860a..... **\$1.00**

FIL. TRANS.
2.5V — 12A
For 66's
\$1.25

EIMAC
150T..... **\$24.50**
50T..... **13.50**

BLILEY mounted crystals..... **\$3.90**

DUNCO KEYING RELAY
2.5V a.c..... **\$2.00** 6V d.c..... **\$2.00**

NEW INSULATED Metallized RESISTORS IRC

Radio's newest, most sensational resistance development. Insulated against shorting — humidity — opens — breakage. Famous Metallized resistance principle. See them at your jobbers. Write for catalog.

INTERNATIONAL RESISTANCE CO.
Toronto, Canada Philadelphia, Pa.



BIRNBACH Superior INSULATORS

HEADQUARTERS for largest and most complete line of Standoff and Feedthru Insulators. 56 numbers; 28 models for every radio purpose. Highest grade white or brown porcelain; nickel-plated brass hardware. Write Dept. Q-10 for Catalog.

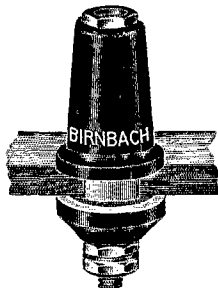

1 1/4" HIGH

All other standard models and sizes from 1/2" down to 3/8" high.

BIRNBACH RADIO CO., Inc.
145 Hudson Street New York City

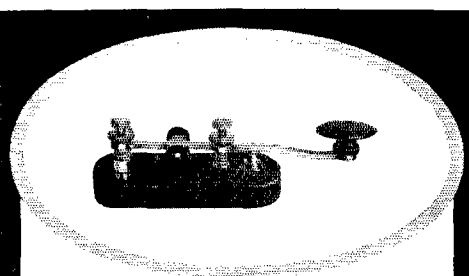

AMATEUR WIRELESS KEY

For amateurs who want an inexpensive, high-grade wireless key, here is the proper instrument. It is equipped with a heavy, cast base, black finish, coin silver contacts, composition knob and nickel parts. The list price is only \$1.50.

The SIGNAL line of telegraph instruments, wireless keys and wireless practice sets is complete. Send for literature.

SIGNAL ELECTRIC MFG. CO.
Menominee, Michigan, U. S. A.

SIGNAL
MANUFACTURERS OF ELECTRICAL PRODUCTS



THE RADIO AMATEUR'S HANDBOOK

THE
WORLD'S STANDARD
AUTHORITY
ON
AMATEUR RADIO

PRICE
ONE DOLLAR
POSTPAID ANYWHERE

AMERICAN
RADIO RELAY LEAGUE
WEST HARTFORD, CONNECTICUT

statement of relative fading, intensity, etc., on the three carrier frequencies; and preference as to audio frequency to be furnished. Correspondence should be addressed National Bureau of Standards, Washington, D. C.

A.R.R.L. QSL Bureau

FOR the convenience of its members, the League maintains a QSL-card forwarding system which operates through volunteer "District QSL Managers" in each of the nine U. S. and five Canadian districts. In order to secure such foreign cards as may be received for you, send your district manager a standard No. 8 stamped envelope. If you have reason to expect a considerable number of cards, put on an extra stamp so that it has a total of six-cents postage. Your own name and address go in the customary place on the face, and *your station call should be printed prominently in the upper left-hand corner*. When you receive cards, you should immediately furnish your QSL manager with another such envelope to replace the used one. List of managers follows:

- W1—J. T. Steiger, W1BGY, 35 Call Street, Willimansett, Mass.
- W2—H. W. Yahnel, W2SN, Lake Ave., Helmetta, N. J.
- W3—R. E. Macomber, W3CZE, 418 10th St., N. W., Washington, D. C.
- W4—B. W. Benning, W4CBY, 520 Whiteford Ave., Atlanta, Ga.
- W5—E. H. Treadaway, W5DKR, 2749 Myrtle St., New Orleans, La.
- W6—C. E. Spitz, W6FZQ, Box 1804, Phoenix, Ariz.
- W7—L. Q. Kelly, W7BPC, 4919 So. Prospect St., Tacoma, Wash.
- W8—F. W. Allen, W8GER, 324 Richmond Ave., Dayton, Ohio
- W9—George Dammann, W9JO, 319 Sherman Ave., Evanston, Ill.
- VE1—J. E. Roue, VE1FB, 84 Spring Garden Rd., Halifax, N. S.
- VE2—W. H. Oke, VE2AH, 5184 Mountain Sights Ave., N. D. G., Montreal, P. Q.
- VE3—Bert Knowles, VE3QB, Lanark, Ont.
- VE4—Dr. J. J. Dobry, VE4DR, Killam, Alberta.
- VE5—E. H. Cooper, VE5EC, 2024 Carnarvon St., Victoria, B. C.
- K4—F. McCown, K4RJ, Family Court 7, Santurce, Puerto Rico.

Oklahoma State A.R.R.L. Convention

JUNE 8th was a rare day in June and, for that matter, in Oklahoma as well. Even the weather marshalled its forces to aid the Ponca City Key Clicker's Club in staging a most successful convention. Flood waters in neighboring states had

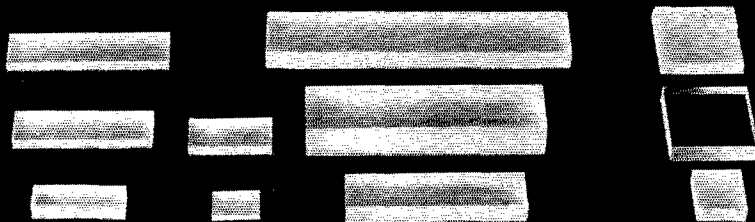
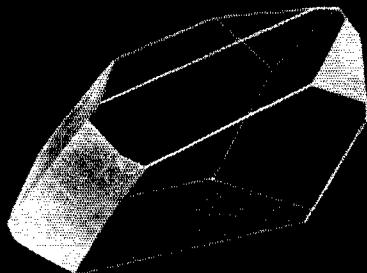

Write for Bulletin 103 describing ISOLANTITE Holders, "AT" Cut Crystals, etc.



PREMIER CRYSTAL LABORATORIES, Inc.
53 PARK ROW, NEW YORK CITY, U. S. A.

PANELS — BAKELITE — RUBBER — ALUMINUM
All Sizes Cut to Order
BAKELITE TUBING & RODS
Drilling, Engraving & Special Work
ALUMINUM CANS — Stock sizes. Special sizes, made to order.
ALUMINUM CHASSIS — Threaded brass studs for 6/32 screws.
Length from 1/2" to 6" — price 5c to 30c.

Insulating bushings
for all size shafts
Bakelite Tubing Threaded to Specifications



Couplings in brass
or Bakelite—15c



UNITED RADIO
MFG. CO.

Est. 1923

Transmitting frames and racks
191 Greenwich St., New York

The Ideal **POWER SUPPLY**
for Your Portable Transceiver

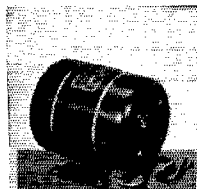

There is wide demand among the 5- and 10-meter crowd for the Pioneer Model "E" Dynamotor. Input 6-V or 12; output 50 watts; 500 volts at maximum output. Write the factory for literature.

PIONEER GEN-E-MOTOR CORP.
466 W. Superior Street CHICAGO

ELECTRO-VOICE

★ The microphones that are known the world over for fidelity and dependability. A full line of Carbon and Velocity types is available at your dealer. Write for Catalog No. 18.

324 EAST COLFAX AVE., SOUTH BEND, IND.

Radio
Engineering
Complete in
Telegraphy-
Telephony

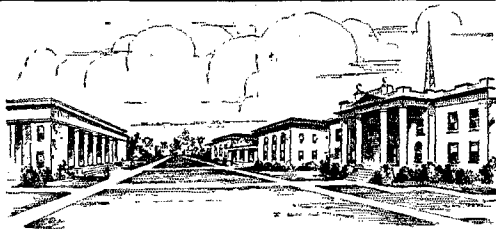

Studio Technique
and Transmitter
Operating Expe-
rience Guaranteed

KPAC

500-Watt

1260 Kilocycles

IN 3 to 7 months we train you to secure Commercial Telegraph Second-class, and Radiotelephone First-class government licenses. Course consists of Wireless Code, Radiophone, Microphone-Studio Technique, Service, Police, and Aeronautical Radio. We are authorized to teach RCA texts. At completion of course you receive practical studio technique experience in our commercial broadcast studios located in administration building, and experience as an operator on K-P-A-C (500-Watt Commercial transmitter located on the campus and owned and operated by the college), and WPA, 4000-Watt Commercial Wireless Station. If interested, write for Bulletin R.

PORT ARTHUR COLLEGE

Port Arthur (world-known port) Texas

This NEW AMATEUR COMMUNICATION RECEIVER

LESS NOISE



GREATER BAND SPREAD

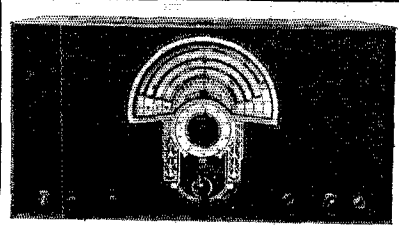

DESIGNED EXCLUSIVELY for 160-80-40 & 20M. HAM BANDS

AMATEURS! Here's the receiver you've dreamed of owning — at a price that makes ownership possible! Its band spread is a sensation and a revelation. Its superior signal-to-noise ratio is an accomplishment of greatly advanced circuit design. Its many practical operating features contributed by many amateurs will thrill all "Hamdom."

Its low cost is due solely to the fact that the Amateur is required to build part of this job himself — a simple task, for the TOBE TUNER comes completely wired and prealigned. Enthusiastic testimonials from critical amateurs concur in the opinion that here is a real communication job giving the finest tuning control obtainable — regardless of price — plus sensitivity, selectivity and low noise level!

If you're looking for BAND SPREAD HERE IT IS!

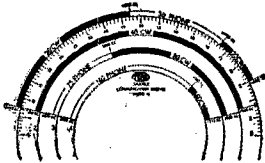

Its distinct appearance is not the only feature of the Amateur Band Dial. Each of the four bands are laid out over a wide area and clearly show the C.W. and phone sections. Here is real

Band Spread: 6½" on the dial on the 20-meter band, 5¾" on the 40-meter band, 4¾" on the 80-meter band, 3¾" on the 160-meter band.

SUPER TUNER — the Heart of the TOBE AMATEUR RECEIVER

For the Amateur who wants to build his own receiver around his own pet circuit — the Tobe Super Tuner is available separately. The unit comes completely wired, tracked and aligned with all accessories for mounting in the chassis so that "building your own" — is reduced to a simple procedure! Ask your nearest jobber about the Tobe Amateur Receiver and the Tobe Super Tuner. If he cannot supply you — write us direct for complete information, FREE literature, prices, etc.

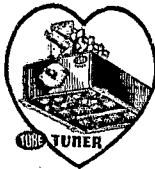

TOBE DEUTSCHMANN CORP.

Canton Dept. Q-105 Massachusetts

subsidized after the highways had been blocked for several days by torrential spring rains.

Hams swarmed in from every direction and registration began shortly after 1:00 p.m. in the lobby of the Jens-Marie hotel. When the evening meeting was called to order approximately 125 visitors had been registered.

The opening session of the convention was called to order at 7:00 p.m. in the grille room of the Jens-Marie Hotel by J. P. Sinnes, W5BWN, president of the Ponca City Clickers Club.

Wayland M. Groves, director of the West Gulf Division, gave an address containing many enlightening subjects to the radio amateurs. This talk was followed by an address by Frank Kratokvil, radio inspector from Dallas, Texas. He showed that the Radio Inspector is a real friend to the hams. A talk on seismographing by E. G. McKinney, Oklahoma City, with illustrations, thoroughly explained how waves travelled and were reflected back to the surface to be amplified and recorded in various ways. Fred Mason, W5CCB, radio engineer of Tulsa, delved into the intricacies of Class B transformers. The final demonstration of the evening was given by W9KKG, a representative of Burstein-Applebee of Kansas City.

An explanation of Sunday's activities was given by J. P. Sinnes. This was followed by adjournment to the club shack, east of the city, where 30 gallons of beer and 15 pounds of pretzels awaited their arrival. A hamburger concession was close by to sate the appetites of those made hungry by Budweiser. All the OW's, YL's, and XYL's were entertained with a showing of Will Rogers in "Doubting Thomas," at the Ponca Theatre.

The Sunday morning session was opened by a business meeting at 9:00. Following this meeting an address was made by N. B. Drake, U.S.N.R. In this talk he explained the work carried on by the United States Naval Reserve, showing its benefits in training radio operators and explaining the interesting drills that are held. A speech was given by Carter L. Simpson, communications manager and state net control station for the A.A.R.S. of Oklahoma, who struck a comparison between the Army and Navy work, explaining the methods of traffic handling and the interest and benefit that may be obtained in this phase of amateur radio. The next thirty minutes were devoted, primarily, to introducing visiting clubs and club members and explaining progress made by neighboring clubs throughout last year. Guy Wilson, W9EL, presented a short program with a talking picture made at the Radio Laboratories at Kansas City. This sketch went over exceedingly well with the amateurs as it was an amateur recording made by amateurs for amateurs. A group picture was taken on the front steps of the Federal Building.

By 1:00 p.m., 165 visitors had registered at the desk. The afternoon session was opened by one of the highlights on the program, a large banquet held in the grille room of the Jens-Marie hotel. Immediately following this dinner a liar's contest

Radiolab's Amateur Buying Guide -Now Ready-

Written By Amateurs For
Amateurs — Its Pages Include —

- Thousands of items required by Amateurs, at the lowest wholesale prices.
- "1936" products of every nationally known manufacturer of "Amateur" equipment—illustrated—described—priced.
- High fidelity head phones. Ultra sensitive, light in weight, crystal operated.
- Multi holder for six crystals, Ace crystals, X, Y and AT blanks.
- Public address and radio service supplies. Valued especially by amateurs employed in those fields. Anodyne Inexpensive transmitter tubes. •
- The "1936" line of ATLAS METAL Racks, Panels and Boxes.
- "1936" Communication Receivers fully described and priced.
- "POLYIRON" I.F. Transformers. An outstanding development. The guide gives specifications and prices.
- The new Transmitting Pentodes and Class "B" Audio Tubes—described fully and priced.
- New Speech Amplifiers using Crystal Microphone Input.
- This carefully compiled "Buyers Guide" will be promptly sent to Amateurs, Dealers and Servicemen.

Radio Laboratories

1515 Grand Ave.,
Kansas City,
Mo.

Mail the Coupon
Get a Copy



Clip This Request Coupon. Hurry It Along to

RADIO LABORATORIES

1515 Grand Ave., Kansas City, Mo.

Please Send Your New "Buying Guide" At
Once, to

.....
.....
.....
Call Letters.....

Check Classification Below

Amateur

Dealer

Serviceman



TUNING DIALS

For EVERY Amateur Purpose

A large moulded bakelite fluted knob with skirt mounted on a nickel silver dial plate with circular finish. Numerals and divisions etched in black enamel. Made in clockwise and counter clockwise rotation.

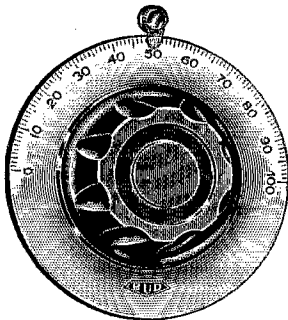

- No. 711 — 1 1/4" Dia. 0-100 in 180°.....Price \$1.00
- No. 712 — 1 3/4" Dia. 100-0 in 180°.....Price \$1.00
- No. 713 — 2 1/4" Dia. 0-100 in 180°.....Price \$1.25
- No. 714 — 2 3/4" Dia. 100-0 in 180°.....Price \$1.25
- No. 715 — 4" Dia. 0-100 in 180°.....Price \$1.75
- No. 716 — 4" Dia. 100-0 in 180°.....Price \$1.75

40% DISCOUNT TO AMATEURS

NEW 1936 Catalog describing numerous new items for the amateur sent FREE upon request

BUD RADIO, Inc.

1937 E. 55th St. Cleveland, Ohio

LEARN RADIO

New Classes Now Forming! Send for 40-page catalog, explains

fully, 190 licensed graduates placed in past 3 years in broadcasting, shipping, police radio, aviation, etc. We teach all branches. Oldest, largest and best equipped school in New England. Equipped with Western Electric sound and broadcasting equipment and RCA marine transmitter. Course prepares for United States Government telegraph or telephone license.

MASS. RADIO SCHOOL, 18 Boylston Street, BOSTON

PRECISION CRYSTALS

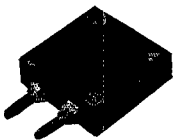

Crystal Holder—\$1.00

NEW low temperature coefficient crystals accurately prepared for maximum power output and frequency stability. These crystals have a frequency drift of only 1/2% or less than that of 'X' cut crystals. Be sure of your transmitter frequency—use PRECISION CRYSTALS. These crystals ground to within 0.1% of your specified frequency and calibrated

accurately to within 0.03% are priced as follows: 1750, 3500 and 7000 kc. band — \$3.50 each. Plugin holder — \$1.00. Jacks for holder — \$15 pair.

The 'AT' cut crystal recently developed has a temperature coefficient of practically zero. 'AT' cut crystals within 0.1% of your specified frequency and calibrated to within 0.03% are priced as follows: 1750 and 3500 kc. bands — \$6.00 each. Holder — \$1.00. Jacks for holder — \$15 pair.

Crystals and ovens for commercial use quoted on at your request. When ordering our product you are assured of the finest obtainable. Now in our sixth year of business.

PRECISION PIEZO SERVICE

427 Asia Street

Baton Rouge, La.

was held, it being possible for anyone present to enter with any story which couldn't be true. There were five entries, and they all put out some pretty "wild" dope but the laurels went to N. B. Drake, W5ASQ, Ponca City. The decision was reached by applause from the group.

Before the drawing of the prizes, a prize was awarded the youngest ham present, Pee Wee Thomas, W5DKY, Oklahoma City, and to the oldest ham present, Dr. Charles D. Hahn, W5BJT, Enid, Okla. Prizes, which were drawn in a selective manner, were donated by approximately 40 companies from all over the United States.

Announcements of forthcoming radio conventions marked the closing of another Oklahoma State A.R.R.L. convention—one of the most successful conventions ever held.

—W5ESH

Maritime Division A.R.R.L. Convention

IT WAS on March 2, 1935, that the Halifax Amateur Radio Club mailed to VE1 hams queries regarding a proposed hamfest for the Maritimes. Responses were slow in coming in and averaged only 16% of those notified. But some good suggestions were received and it was definitely settled that the H.A.R.C. would go ahead with preparations for the week-end of June 1st to 3rd, the convention to be held in Halifax.

June 1st arrived. Indications pointed for cold and foggy weather. Old Sol forgot to show his face that day. From 2:30 p.m. registrations were made in the lobby of the Lord Nelson Hotel and the out-of-town boys gathered in groups, meeting old contacts and new friends. The banquet opening the convention was set for 7:30 at the Lord Nelson where the main ballroom was set for the occasion. It was nearer 8 o'clock when the gang of sixty OM's, YL's and XYL's pricked up their ears as 1BC, with an oscillator assembly from the ballroom, sent out a CQ for them to take their places at the tables.

"God Save the King," played by VE1FN, opened the hamfest and after a word of welcome from the president, VE1EK, the serious business of satisfying the hungry got under way—but not before two flashlight pictures were taken. During the last course Toastmaster Major W. C. Borrett, VE1DD, proposed a toast to the King. Then our Canadian General Manager, Alex Reid, VE2BE, was toasted, to which he responded, and followed with the main speech of the evening.

Art. M. Crowell, VE1DQ, our S.C.M., next said a few words of interest to the Maritime Section.

Major Borrett lent some witticisms in his narration of old-time radio of about twelve years ago and anecdotes in connection with the I.A.R.U. Congress held in Paris in 1925.

Joe Fassett, ex-C1AR, ex-VE1AR, and "The Old Man" of Maritime Amateur Radio, was next on the program. His reminiscences of the "old days" were very interesting and humorous and kept the 60 present in roars of laughter. It is said that Joe has at home a trunk, of about the usual

EVERYTHING FOR THE HAM

DISTRIBUTORS

c - q
de
W5CXQ

DISTRIBUTORS

R.C.A.
Arlab
Alden
Federal
Aerovox
Mallory
Belden
Hammarlund
Clarostat
Carron
Universal

866 TUBES
1.95

R.C.A. 803
PENTODE TUBE
38.50

R.C.A. 802
TUBE
3.90

OHMITE BAND
SWITCHES
1.80

CARBON RESIS-
TORS ALL SIZES
5c EACH

AEROVOX
2MFD 2000V
3.90

AEROVOX
100,000 OHM
200 WATT
2.10

AEROVOX
.002 1000V
MICA
27c

NATIONAL
RADIO
DESIGN
1.00

I.R.C.
Kester
Burgess
Sprague
Electrad
Yaxley
Turner
National
Supreme
Thordarson
I.C.A.

RCA DeForest Transmitting Tubes

SHULER SUPPLY CO.

NEW ORLEANS, LA.
SERVING THE SOUTH

R A D I O

ENGINEERING, broadcasting, aviation and radio telegraphy and telephony. Morse telegraphy and railway accounting taught thoroughly. Engineering course of nine months duration equivalent to three years of college radio work. School established 1874. All expenses low. Catalog free. **DODGE'S INSTITUTE**, Day Street, Valparaiso, Indiana

LEARN CODE

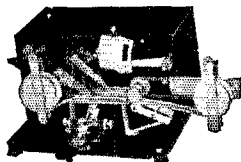

the way you'll
be using it—

BY SOUND

There is only one way to learn to read code and that is by listening to code. There is one best way to learn to send code and that is by hearing your own sending repeated back to you. With the Master Teleplex Code Teaching Machine you learn code the natural, easy, fascinating way. Only instrument ever produced which records your sending in visible dots and dashes (on copper tapes) — then SENDS BACK your own key work at any speed you desire. We furnish complete course, lend you the New Improved Master Teleplex, give you personal instruction with a **MONEY BACK GUARANTEE** — all at a surprisingly low cost per month. Write today for **FREE** catalog Q. 34. No obligation.

TELEPLEX COMPANY

76 Cortlandt St.

New York, N. Y.

"MASTER TELEPLEX — The choice of those who know"

HOYT METERS for RADIO AMATEURS

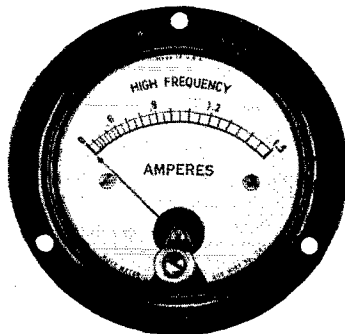

A complete line of panel mounting Milliammeters, Ammeters, Voltmeters — D.C. and A.C., High Resistance D.C. Voltmeters, R.F. Antenna Ammeters (Hot Wire Type), Pocket Battery Testers in all popular ranges.

Amateur transmitters and amplifier systems require accurate meters for operating control. For the first time Hoyt offers such meters in standard ranges at low attractive prices.

The *New Hot Wire Ammeter* for transmitter output is particularly interesting. It is not affected by frequency changes, comes in flush mounting bakelite case and is supplied in three ranges. Ask your distributor to show you these inexpensive fine instruments.

BURTON-ROGERS COMPANY

Sales Division of Hoyt Electrical Instrument Works
755 Boylston Street, Boston, Mass.

The **CT-60** TRANSMITTER or DRIVER

An RK-20 TRI-TET for 3 band operation featuring crystal control, complete band switching and with provision for phone operation.



As a transmitter, the CT-60 will deliver 50-60 watts into the antenna, and as a driver will excite a higher powered amplifier up to 400 watts input on the crystal fundamental. Modulated in the suppressor grid with CT-60M modulator, a 15 watt carrier may be had in the 160 and 75 meter phone bands.

Model A, 160-80-40 meters, less power supply \$33.00
 Model B, 80-40-20 meters, less power supply \$15.00
 RK-20 tube tested in your set. \$15.00

CT-60M MODULATOR

This unit is mounted on a steel base finished in aluminum duco and contains an integral speech amplifier and power supply. Although primarily designed for use with the CT-60 transmitter, it may be used to modulate the suppressor of one or two RK-20, RK-28 or similar type pentodes. Two models are furnished for your convenience.

Model X for crystal microphone \$16.80
 Model C for single or DB carbon microphone \$1.43
 Set of tested tubes. \$1.43

Write for descriptive circular

AVAILABLE IN NEW ENGLAND FROM YOUR DEALER. OTHERS ORDER DIRECT

HARVEY RADIO LABORATORIES
 12 Boylston Street Brookline, Mass.

200% PERFORMANCE FROM YOUR 'PHONE with this "Communications-Type" CRYSTAL MICROPHONE

SHURE MODEL 70S

Yes -- you can actually DOUBLE your "Side-Band" power on the highly important "intelligibility" speech frequencies with this new "Communications-Type" Crystal Microphone -- the first designed for high-efficiency speech transmission. Specially-engineered rising curve for clear, crisp, powerful speech . . . cuts through noise and static. No transmitter changes . . . connect as you would an ordinary crystal microphone.

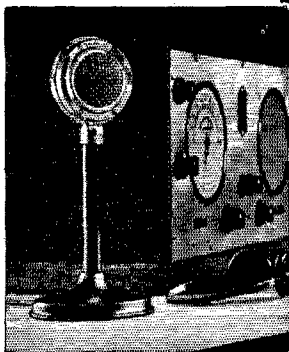

• The 70S lists at only \$25, complete with integral Desk Mount and 2-conductor shielded cable.

Ask your jobber for complete information.

SHURE BROTHERS COMPANY
 Microphone Headquarters
 215 WEST HURON ST. CHICAGO, ILLINOIS

steamer size, which is crammed full of QSLs, a large percentage being DX cards.

Following Joe we heard from T. J. Nolen, VE1BY, and local R.I. In his wanderings throughout the Maritimes he has had to adjust ham interference to the satisfaction of the BCL's and being a ham himself he cannot let us take the rap entirely. He expressed his thanks to the boys for their coöperation and willingness.

Len Foster, VE1EF, was responsible for donations of prizes for this event. Much credit is due him.

VE1YL was taken by surprise when called on for a few words. Now married to VE1EK, she has been operating two years and still retains her call. She was the only lady owner of a station present.

Following the speeches the drawing for door prizes took place.

The Maritime ham from the farthest point was VE1FW.

In the code contests commercial operators were barred. The transmitting contest (speed and accuracy) was won by VE1FN (1st), VE1FT (2nd) and VE1CE (3rd). The receiving (speed) contest was won by VE1GL (1st), VE1BZ (2nd) and VE1EA (3rd). We wish to thank T. J. Nolen, VE1BY, W3EBB and G. V. R. Goddard of the U. S. Cutter *Mendota*, for their coöperation and judging of participants in the code contests. As the result of two other contests, VE1CE was proclaimed the champion Rag Chewer, and VE1BC the champion Wind Bag of the Maritimes.

Initiation into the R.O.T.A.B. for those qualifying was the final feature of the first day of the hamfest. VE1YL (wife of VE1EK) was the first initiated, followed by Mrs. Horne (wife of VE1DC). These were the first ladies in the Maritimes to receive the R.O.T.A.B. Certificate. About twenty-eight of the OM's were put through the degree, and it was after 1:00 a.m. Sunday morning when the party broke up. Joe Fassett performed the initiation rites.

Sunday arrived. Some visits to local stations were made by out-of-town hams in the morning, but the majority slept in after the exciting time the night before. At 1:30 p.m. the gang gathered near the Elmwood Hotel for the outing planned at Lower Sackville. About fifteen cars were on hand and those were packed. Five-meter equipment—about seven transceivers—was in use during the ten-mile ride to Bedford where, through the kind coöperation of Major Borrett, CHNS was inspected. The radiator is a steel tower 220 ft. high and is the last word in vertical radiation. After this pleasant visit the gang continued on to the field day site which is situated on the Old Sackville Road and borders the Sackville River.

One 5-meter set was kept on the grounds while five cars so equipped set forth and scattered along the by-roads. Due to the hills about five miles was the best DX.

The first event on the sports program was a soft-ball game between the married and single men. Although the benedicts out-hit the single



**LOOK UNDER THE CHASSIS
FOR THE C-D LABEL**

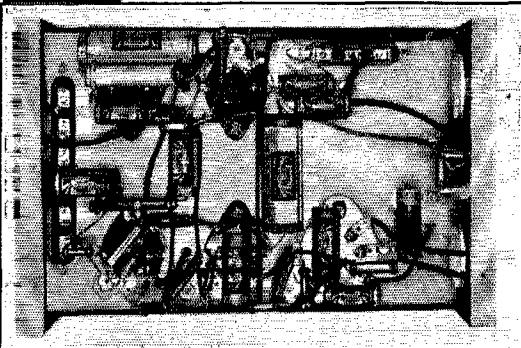

Photo courtesy of Eastern Radio Specialty Co. "Peak Preselector"
"Thousands in use and not one reject."

B. Herbert Russ, Chief Engineer

This is characteristic of the world-wide comments we receive regarding our condensers.

HAMS— you will find **C-D ELECTROLYTIC, OIL, MICA, AND PAPER** condensers used exclusively by the leading manufacturers of reliable radio equipment.

Get the full information on this complete line of quality condensers. Catalog 128 now available free of charge.

CORNELL-DUBILIER

CORPORATION

4373 BRONX BOULEVARD
NEW YORK

"The Crystal Specialists Since 1925"

PIEZO-ELECTRIC CRYSTALS

Guaranteed Accurate to BETTER than .01%

SCIENTIFIC RADIO SERVICE

UNIVERSITY PARK, HYATTSVILLE, MD.

GULF RADIO SCHOOL

Radiotelegraphy Radiotelephony

Radio Servicing

SECOND PORT } 1007 Carondelet Street
U. S. A. } NEW ORLEANS, LA.

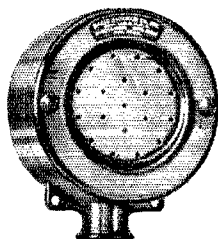

The Superiority of Our
DYNAMIC MICROPHONE

Over Other Types Is
Mainly in Its Sensitivity
No high gain preamplification required. No background noise. No Power Supply. AND THE **\$33**
PRICE

U. S. PATENTS PENDING

Send for Bulletin 3011

RADIO RECEPTOR CO., INC.

110 Seventh Ave., New York City

Q-MAX "3"

R.F. COATING AGENT

An outstanding achievement resulting from the collaboration of organic chemists with radio engineers, Q-Max No. 3 Lacquer makes a distinct contribution to radio communications. Now, for the first time, a coating medium is available which may be applied freely to R.F. components, without appreciably altering circuit constants. Heretofore, it was necessary to impregnate or coat R.F. parts with finishing lacquers never intended for R.F. service, the use of which results in high circuit loss and instability.

Q-Max No. 3 is extremely low in dielectric absorption. Either as a liquid or in the form of a deposited film it has a small fraction of the loss of cellulose lacquers and varnishes. Its dielectric constant is less than 3.0 at 1500 KC. It is remarkably resistant to moisture.

Q-Max No. 3 is used by foremost radio manufacturers for obtaining moisture repellent exteriors on scores of different radio articles. For sealing porous dielectrics, anchoring coil wires, stiffening self-supporting inductors and as an impregnant or saturant, it is unsurpassed.

Q-Max No. 3 is obtainable by amateurs and experimentors in 25c containers. An increasing number of radio dealers and mail order distributors are carrying Q-Max No. 3. If you cannot obtain it, tell your local supplier to write us. We make it profitable for him to have it always available for you. No shack is complete without it.

Communication Products, Inc.



245 CUSTER AVE., JERSEY CITY, N. J.

Tomorrow's
MAGNETIC SPEAKER
Today!

The Revolutionary NEW
WRIGHT-DECOSTER "HYFLUX"

The answer to the demand for Quality
at a Price

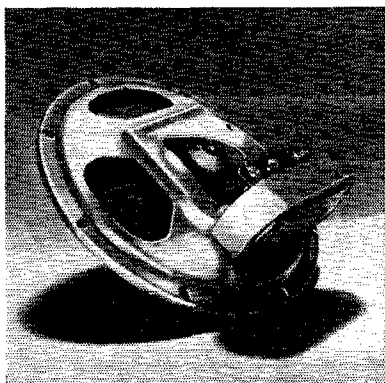

Write for complete catalog, dealer's discount and name of nearest distributor. Wright-Decoster distributors are always anxious to cooperate with you.

WRIGHT-DECOSTER, INC.

2259 University Ave.

St. Paul, Minn.

Help

For The AMATEUR

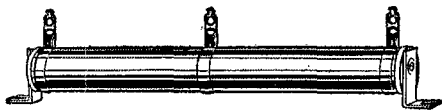

USE Electrad Wire-Wound, non-inductive Grid Leaks and your tubes will be protected against damage due to loss of bias. Guaranteed not to develop noise or open circuits. 50, 100 and 200-watt sizes, in permanent vitreous enamel, \$1.35 to \$2.50 each list.

Write Dept. Q-10 for Complete 1936
Catalog of Resistors for All Purposes



men, the latter won, 9-8. As VE2BE was formerly a semi-pro ball player we wonder if we have lost our amateur status! Hi! Various races were run off, both for the YL's and OM's. Prizes for the girls were varied kitchen helps; for the hams, small parts, always acceptable.

To a CQ on a car horn the crowd rushed across the field to supper where places were laid in a large circle on the grass near the river bank. Cold meat, sandwiches, pie, cake, and cookies with coffee, comprised the repast. After supper more sports were indulged in, mixed with 5-meter work. About 8:30 all started back to Halifax.

On Monday morning, June 3rd, the Dingle, N. W. Arm, was the objective. The Memorial Tower, which rises over 200 feet above the Dingle, made an ideal spot for the pivot 5-meter station, while cars drove around testing their equipment. It is the belief that before the summer is over the local hams will have built several transceivers of their own for local QSO's. As judging commercial equipment against home-made apparatus appeared difficult, the prize for the 5-meter transceiver was drawn, with VE1CP the lucky person.

In the transmitter-building contest enough parts and straight wire were supplied the contestants. The Hartley circuit was chosen and knives, screwdrivers and pliers were barred. The set had to oscillate and light up a bulb on a loop. VE1BC in 20 minutes and VE1AW in 21 minutes were respectively first and second.

The executive of the H.A.R.C., which planned and carried off so successfully the finest hamfest ever held in the Maritimes, consists of VE1EK, president, VE1FO, vice-president, VE1FN, secretary and VE1FB, treasurer.

The committees were: *Social*, VE1AW, Chairman, and VE1GR; *Arrangements*, VE1EF, Chairman, and VE1AA, VE2DF; *Equipment*, VE1FO, Chairman, VE1BC and VE1CP; *Publicity*, VE1FB, Chairman, VE1FN and VE1GL.

At 1:30 p.m. on Monday, June 3rd, the Maritime Convention was over for 1935, with requests that a bigger and better one be held in 1936.

I.A.R.U. News

(Continued from page 58)

number of countries now permit all the Madrid treaty bands. In some other cases buffer widths have been narrowed. The entire picture is one of progress, of the steady expansion of usable territory, of pressing out against the basic boundary, of increased recognition on the part of governmental authority of the ability of the amateur to keep within bounds, resulting in the elimination of artificial barriers.

For information concerning other countries than those mentioned here, reference is made to the article previously mentioned, on page 52 of the August, 1934 issue of *QST*. Copies are available from *QST*'s circulation manager. In these two reports, about twenty of the principal nations have been discussed. Information from other



Mr. E. H. Kietzke, President of CREI and originator of the first thorough course in Practical Radio Engineering.

IS YOUR FUTURE WORTH 3c . . . ?

The investment in a postage stamp to write for our catalog, will bring you dividends that just "plugging along" will never accomplish. The big jobs in radio go to the men who are **TECHNICALLY TRAINED** to rise above the ranks of the average. Time is money. If CREI training can increase your ability . . . it can also increase your income.

A Course of Study to Meet Your Needs

Residence or home-study, there is a CREI course to meet your requirements and terms to meet your budget.

"INVEST" 3 Cents Now . . . Write
Today for FREE Illustrated Catalog

This 44-page illustrated booklet gives complete details of all course and illustrations of "labs" and equipment.

**CAPITOL RADIO
ENGINEERING INSTITUTE**
14th and Park Road, N. W. Dept. Q-10
WASHINGTON, D. C.



To Get Started in Amateur Radio
obtain a copy of

HOW TO BECOME A RADIO AMATEUR

(No. 8 in the A.A.R.L. series entitled
The Radio Amateur's Library)

Completely done over in 1935 style, telling all about
amateur radio and describing the latest equipment.

- push-pull crystal transmitter
- bandspread receiver
- simplest of monitors
- giving modern operating instructions

The fourth edition of "How to Become a Radio Amateur" marks another milestone in amateur development. Universally recognized as the standard elementary guide for the prospective amateur.

25c postpaid anywhere
(no stamps please)

The American Radio Relay League
West Hartford, Connecticut

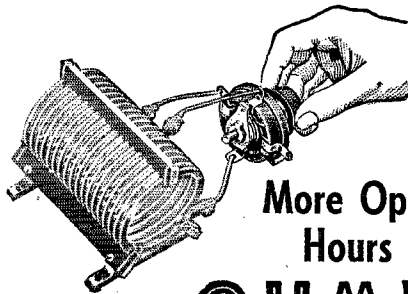

More Operating Hours with **OHMITE BAND-SWITCH**

(Patents Pending)

SEND FOR
CATALOG 14
JUST OFF
THE PRESS

Twelve pages of
live data and in-
formation about the
new resistors and
rheostats now avail-
able for amateur
use in transmitters
and receivers.

It's no fun operating when inter-
ference chokes your band, and
you must change coils and re-tune
if you want to change frequency.
That's why there's such demand for
the OHMITE Band-Switch!
Mounted on your control panel,
it gives you instant QSY (fre-
quency change). Bulletin 104
gives diagrams for all basic trans-
mitter circuits.

OHMITE MANUFACTURING COMPANY
631 North Albany Avenue CHICAGO, ILLINOIS



New Littelfuse Catalog

SEND FOR YOUR FREE COPY

Big valuable and indispensable book
tells about Instrument, Hi-volt, Neon,
Aircraft, Auto Fuses; Indicators, Etc.
Write today.

Littelfuse Labs., 4246 Lincoln Avenue, Chicago, Illinois

RADIO ENGINEERING

RCA Institutes offers an intensive course of high standard
embracing all phases of Radio. Practical training with
modern equipment at New York and Chicago
schools. Also specialized courses and Home Study
Courses under "No obligation" plan.

Illustrated Catalog on request.

RCA INSTITUTES, INC. Dept. ST-35
75 Varick St., New York 1154 Merchandise Mart, Chicago
Recognized Standard in Radio Instruction Since 1909

A
COMPLETE
30 or 60 MC.
MOBILE
and
PORTABLE
STATION

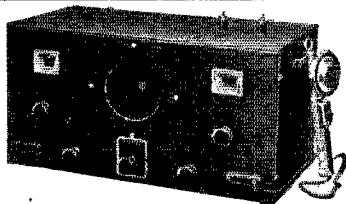

TR-6A6. TWIN-TRIODE DUPLEX TRANSMITTER-RECEIVER UNIT

RK34 or 6A6 Push-Pull Oscillator 6A6 Class B Modulator
6A6 Class A Driver Tuned R.F. super-regen. Receiver Integral
Dynamic Speaker

WRITE FOR BULLETIN C

RADIO TRANSEIVER LABORATORIES
86-27—115th Street, Richmond Hill, N. Y.

AMPERITE

HIGH LEVEL VELOCITY

(HIGH IMPEDANCE-2000 OHMS)

OPERATES WITHOUT PRE-AMP

ELIMINATES HUM/TROUBLE

THIS MICROPHONE IS HIGH ENOUGH IN IMPEDANCE TO OPERATE DIRECTLY INTO GRID . . . BUT NOT HIGH ENOUGH (ONLY 2000 OHMS) TO INTRODUCE SERIOUS LOSSES IN LINE UP TO 200'.

Requires no pre-amp when used with regular high gain amplifier (100 DB). Replaces condenser and crystal microphones—NO CHANGES or additions necessary! ELIMINATES INPUT TRANSFORMER and its losses. Therefore requires 12 db. less overall amplification. . . Eliminates inductive hum. NO FEEDBACK.

LIFELIKE BRILLIANCE

The High Level Velocity reproduces both speech and music with their original brilliance. Also excellent on close talking.

MODEL RB-H. for speech and music . . . LIST \$42.00 with coupling

RS-H. for speech; can also be used for music LIST \$32.00 with coupling.

AMPERITE Company, 561 BROADWAY N.Y.C. Write for Bulletin HL

AMPERITE *3-POINT Velocity* **MICROPHONE**

EIMAC

**AT ANY PLATE
VOLTAGE AND
ANY FREQUENCY
EIMAC TRANS-
MITTING TUBES
DO A BETTER JOB**

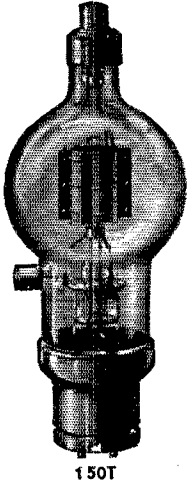

150T

Ask your dealer for a copy of our new tube booklet giving tube characteristics and application notes.

150T — \$24.50 50T — \$13.50

AT YOUR DEALER
"COMPARE AND REFLECT"

EITEL-MCCULLOUGH, INC.
SAN BRUNO, CALIF.

lands, particularly those not members of the I.A.R.U., is earnestly solicited, in order that it may be reproduced herein for the general good as well as to record another step in the steady progress of amateur radio's international prestige.

—C. B. D.

Standard Frequency Transmissions

| Date | Schedule | Station | Date | Schedule | Station |
|---------|----------|---------|---------|----------|---------|
| Oct. 2 | BB | W9XAN | Nov. 1 | BB | W6XX |
| Oct. 4 | BB | W6XX | | A | W9XAN |
| | A | W9XAN | Nov. 2 | BX | W6XX |
| Oct. 5 | BX | W6XX | Nov. 3 | C | W6XX |
| Oct. 6 | | | Nov. 8 | A | W6XX |
| Oct. 6 | C | W6XX | Nov. 15 | B | W9XAN |
| Oct. 11 | A | W6XX | | B | W6XX |
| Oct. 18 | B | W9XAN | Nov. 20 | C | W9XAN |
| | B | W6XX | Nov. 22 | B | W9XAN |
| Oct. 23 | C | W9XAN | | A | W6XX |
| Oct. 25 | B | W9XAN | Nov. 27 | BB | W9XAN |
| | A | W6XX | Nov. 29 | BB | W6XX |
| Oct. 30 | BB | W9XAN | | A | W9XAN |
| | | | Nov. 30 | BX | W6XX |

Schedules for WWV

EACH Tuesday, Wednesday and Friday (except legal holidays), the National Bureau of Standards station WWV will transmit on three frequencies as follows: noon to 1:00 p.m. E.S.T., 15,000 kc.; 1:15 to 2:15 p.m., 10,000 kc.; 2:30 to 3:30 p.m., 5000 kc. On each Tuesday and Friday the emissions are continuous unmodulated waves (c.w.); and on each Wednesday they are modulated by an audio frequency. The audio frequency is in general 1000 cycles per second. These emissions are accurate to better than 1 part in five million at all times and are readily useful for calibrating amateur-band frequency meters by harmonics from an auxiliary 100-kc. oscillator, as described in previous *QST* articles (June and October, 1933; February, 1934), and for checking audio-frequency generators.

Kansas State Convention

(Continued from page 12)

cordial invitation to radio amateurs to visit us and have two days of real goodfellowship. Mr. W. A. Beasley, Secretary, 1451 Byron Ave., Topeka, Kans., will answer any inquiries regarding further details.

Amateur Radio Stations

(Continued from page 61)

second the two R.K.-20's in push-pull. The final is modulated on the suppressor grids by a two-stage speech amplifier consisting of a 57 feeding a 2B6. The microphone is a W.E. double-button carbon. The transmitting antenna is a 66-foot Zepp. The input runs 200 watts on c.w. and 125 watts on 'phone, giving about a 40-watt carrier for 'phone work. The receiver is an FBXA, used with a doublet antenna.

Although W9JIR is of comparatively recent date, the operator first broke into ham radio back in 1922, when a pair of 202's did yeoman duty under the call 9DFK. Commercial radio work kept him out of it for a time (he's now engaged in engineering work for one of the big networks), but the old urge couldn't be downed. W9JIR is the result.

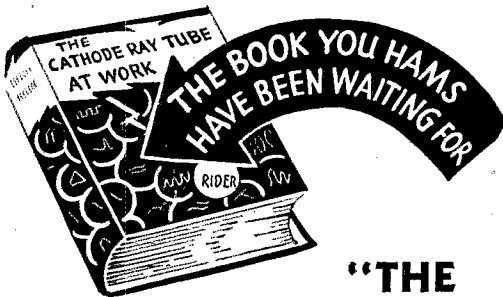

"THE CATHODE-RAY TUBE AT WORK"

320 pages crammed full of actual facts as to the workings of the cathode ray tube — and hundreds of oscillograms taken during actual experiments in Rider's Laboratory.

If you want to be up-to-date in your "Ham" activities, get a copy of this book. You really can't afford to be without it. Every phase of the cathode-ray tube in operation is thoroughly covered — both in text and with graphic illustrations.

YOUR COST **2.50**
POSTPAID



EBY Announces



TYPE 12-E METAL TUBE SOCKET

A new 8-prong moulded Bakelite Universal Socket for all Octal metal shield tubes. New double action phosphor bronze springs.



TYPE 8-E SUB-PANEL MOUNTING

Similar to 12-E but designed with laminated Bakelite base for convenient sub-panel mounting.

EBY Quality Radio Products are sold by leading jobbers. Write today for our catalog of service, amateur and experimental parts including:

- BINDING POSTS
- AC SWITCHES
- SHORT WAVE SWITCHES
- TIP JACKS
- TAP SWITCHES
- MALE & FEMALE PLUGS, etc.

HUGH H. EBY Inc.
2066 Hunting Park Ave.
PHILADELPHIA, PENNA.

TURNER

**UNIFORM
PRECISION**



The MU-X MICROPHONE SERIES has

received as complete an approval as the very popular type G. The Mu-X, in conjunction with one of the several Turner microphone amplifiers, produces a characteristic extremely flat over the usable audio band.

Write now for specifications and illustrations of the complete line of crystal equipment.

Licensed under patents of
The Brush Development Company

THE TURNER COMPANY
CEDAR RAPIDS, IOWA
U. S. A.

RAYTHEON VOLTAGE REGULATOR

Stabilizes AC Voltages to $\pm 1\%$

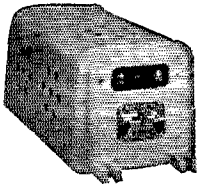

Type VR-2
60 WATTS
\$27.00

Input may fluctuate from 95-130 volts AC. Load may fluctuate from 0 to full load. Output will remain 115 volts $\pm 1\%$. Time constant is negligible. Automatic — no moving parts or adjustments. Sizes up to 2000 watts.

Write for Bulletin DL-48-710Q

RAYTHEON MANUFACTURING CO.

Electrical Equipment Division

190 Willow Street ■ Waltham, Mass.

ACME-DELTA, RAYTHEON, AND DELTA
PRODUCTS

Candler Trained Operators LEAD THE FIELD FOR SPEED AND ACCURACY

Use the Candler System that has produced the fastest commercial and amateur operators in the business for the last twenty-four years.

Candler trained operators read code as easily as print and make accurate "mill" copy by touch at high speeds.

DON'T HESITATE, if you have the slightest difficulty with your code, call on Candler for the specialized training and personal coaching that have made Candler trained operators outstanding for the speed and accuracy of their work.

You can keep pace with these speed artists among the Morse and Radio operators with Candler training. Your amateur or commercial license is guaranteed.

We have an interesting story by Ted McElroy telling how he became the world's fastest Radio Operator which will be sent you together with the New Book of Facts. Send for it, no obligation is incurred.



CANDLER SYSTEM CO.
DEPT. Q-10 ASHEVILLE, NORTH CAROLINA

THORDARSON

Transformers for Plate Modulation of Pentodes

(See QST, Sept., 1935, page 13)

These new transformers have two secondaries — one for plates and one for screens.

T-7826 — Class B 801's to two RK20's. List \$15.00.

T-7827 — Class B 800's or RK18's to 803 or RK28. List \$18.00.

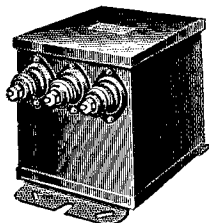

See Your Jobber or Write for
Bulletin SD-227

THORDARSON ELECTRIC MFG. CO.
500 W. Huron St., Dept. B Chicago, Ill.

Here's Some Good News:—

NATIONAL OSCILLOSCOPE complete
With RCA 906 and 80 tubes

\$9.95 DOWN Balance in Small
Monthly Payments

DELAWARE RADIO SALES CO.
405 Delaware Ave. Wilmington, Delaware

RADIO COURSES

RADIO OPERATING: Prepare for Gov't License Exam. ●
RADIO SERVICING: Including Short Wave ● AMATEUR
CODE ● New Course in RADIO ELECTRONICS; All Day
One-Year Course Starts September 23.

Resident Courses — Write for Booklet

NEW YORK YMCA SCHOOLS 4 West 63rd Street
New York City

New
MICA CONDENSERS
Compact
ENCASED IN PORCELAIN



"HAMS" A Real Low-Loss ... Leak Proof ... Moisture Proof ... Excellent Power Factor Condenser. Truly a remarkable Engineering achievement accomplished after many expensive and painstaking experiments. Really a precision unit at even a lower price than most ordinary condensers. Available in 2 1/4% capacity tolerance and 5000 Volt construction. Write for catalog sheet and color Chart.

AMAZING QSL OFFER — SEE HAM-ADS

See your nearest Jobber or write direct to:
FILTERMATIC MANUFACTURING CO.
Tacony, Philadelphia, Penna.

Delta Division Convention

(Continued from page 18)

sentative for R.C.A. Mfg. Co., who will have many new things to talk about.

Just note the convention is on Saturday and Sunday, October 19th and 20th. Write E. R. Arledge, Chairman, P. O. Box 286, Pine Bluff, Ark., for further information.

Silent Keys

It is with deep regret that we record the passing of these amateurs:

Gordon A. Back, W8LUF, Port Leyden, N. Y.

Ora J. Barnes, W9RPT, Mt. Morris, Ill.

Richard E. Boerstler, W8HDF, Lancaster, Ohio

Edward C. Daoust, Jr., W8GGV, Cleveland, Ohio

James L. Carter, W8FOE, Fostoria, Ohio

H. L. Garfath, G2BM, London, England

Morris Goldblum, W2HBI, Huntington, N. Y.

Roy S. Goldman, W9NDF, St. Louis, Mo.

Herbert D. Gottfried, W2HQK, Brooklyn, N. Y.

LeRoy Haley, W9GNK, Tacoma, Colo.

George Wallace Hancock, W9UEM, Kansas City, Mo.

Karl E. Keller, W9BDB, Wichita, Kans.

Gene E. Kelly, W9RYU, Page, N. Dak.

Robert B. Kineke, W2HOB, Maplewood, N. J.

Buford A. Mathes, W4ADX, Johnson City, Tenn.

Daniel J. McCloskey, W2FAJ, New York City

Bert O. Pearson, Tupman, Calif.

Elwood W. Scott, W8LNP, Williamsport, Pa.

James W. Seshier, W8HH, Marietta, Ohio

Joseph S. Wantuck, W2GRC, Yonkers, N. Y.

Hugh E. Williams, W6EU, Vallejo, Calif.

C. Myrle Wood, W7EAL, Helena, Mont.

Atlantic Division Convention

WET skies did not dampen the attendance at the Syracuse Hotel, Syracuse, N. Y., for the divisional convention on June 21st and 22d. Tennis and golf matches were cancelled with the exception of one golf match that rain could not discourage.

On Friday afternoon those portable 5-meter receivers aboard autos braved the weather to hunt the hidden transmitter. Many participated in this popular event and the winner, W8JTE, only took 35 minutes to make the "kill." Those present at the hidden transmitter (four miles

(Continued on page 108)

Designed to Meet Your Needs!

THE ARRL LOG BOOK!

PARTICULARLY designed to comply in every respect with the detailed regulations of FEDERAL COMMUNICATIONS COMMISSION regarding logkeeping, providing for the recording of every item of required information, while at the same time reducing the maintenance labor to an absolute minimum. To this end places are provided on the inside cover and at the page heads to log basic information which may stand for long periods of time, and the actual logging of transmissions is reduced to a very simple operation. To accomplish this the column arrangement has been completely redesigned, resulting in the most convenient log it has ever been our pleasure to offer.

AMATEUR RADIO STATION LOG

(PER) Input power to last stage, _____ watts
 Frequency, _____
 Type of emission, _____

If operating as portable or portable-mobile:
 Approximate location, _____
 Type of vehicle or mobile unit in which installed, _____

| DATE TIME | STATION CALLED | CALLED BY | STATION HEARD OR WORKED | | | | IF QSO RESULTED: | | | | CHANGES FROM PREVIOUSLY RECORD- ED DATA, MESSAGES, REMARKS, ETC. | |
|--------------|-------------------|--------------|----------------------------|---|---|---|------------------|---|---|--------------------------|---|--|
| | | | KC. OF DIAL | R | S | T | R | S | T | TIME OF ENDING QSO | | |
| | | | | | | | | | | | | |
| | | | | | | | | | | | | |
| | | | | | | | | | | | | |
| | | | | | | | | | | | | |
| | | | | | | | | | | | | |
| | | | | | | | | | | | | |
| | | | | | | | | | | | | |
| | | | | | | | | | | | | |
| | | | | | | | | | | | | |
| | | | | | | | | | | | | |

COLUMNS are provided for recording signal reports by the R-S-T method, both as to your observation of the station contacted and as to the other fellow's report of your signals. The QSA- and R- scales are given with suggestions for logging by that method if desired. Everything has been thought of. There is, for instance, a column for the time of end of QSO. The arrangement is such that the QSO's stand out on the page and may readily be spotted when looking up records. Moreover, the new page heading makes the log as useful for mobile or portable operation as it is for fixed. Covers contain frequently-consulted data on the R-S-T system of signal reporting, Q abbreviations, prefixes, abbreviations, etc.

Thirty-eight ruled pages, one page graph paper with reverse side of all pages blank for notes

**IN BOOK FORM FORTY CENTS EACH,
THREE FOR ONE DOLLAR, POSTPAID**

THE AMERICAN RADIO RELAY LEAGUE
WEST HARTFORD, CONNECTICUT

Where to buy it

A directory of suppliers who carry in stock the products of these dependable manufacturers.

ASTATIC
Crystal Microphones and Pickups

ASTATIC MICROPHONE LABORATORY, Inc. YOUNGSTOWN, O.
Pioneer Manufacturers of Quality Crystal Products

LOS ANGELES, CALIF. 1701 S. Grand Ave.
Radio Television Supply Co.

SAN ANTONIO, TEXAS 301 S. Flores Ave.
Straus Frank Company

SAN FRANCISCO, CALIF. 1452 Market St.
Offenbach Electric Company, Ltd.

SPOKANE, WASH. 611 First Ave.
Spokane Radio Company, Inc.

BURGESS BATTERY COMPANY
"Chrome" protected
RADIO BATTERIES
Look for the Black and White Stripes
FREEPORT, ILLINOIS

ATLANTA, GEORGIA 430 W. Peachtree, N. W.
Wholesale Radio Service Co.

CHARLOTTE, N. C. 205 W. First St.
Shaw Distributing Co.

SAN FRANCISCO, CALIF. 1452 Market St.
Offenbach Electric Company

Super SKYRIDER
the hallicrafters

FORT PIERCE, FLORIDA 112 North 2nd Street
Watkins Radio Service

SAN FRANCISCO, CALIF. 1452 Market Street
Offenbach Electric Company

SPOKANE, WASH. 611 First Ave.
Spokane Radio Company

E.F. JOHNSON COMPANY
Specialists in
RADIO
TRANSMITTING EQUIPMENT
WASECA, MINN.
U.S.A.

ATLANTA, GA. 430 W. Peachtree, N. W.
Wholesale Radio Service Company

COLORADO SPRINGS, COLO. 117 E. Pikes Peak Ave.
Tel-Rad, Inc.

LITTLE ROCK, ARK. 409 W. 3rd St.
Beem Radio Company

MEMPHIS, TENN. 223 So. Front St.
Riechman-Crosby Company

RENO, NEV. Arcade Building
J. D. Mariner Music House

SAN FRANCISCO, CALIF. 1452 Market Street
Offenbach Electric Company

SEATTLE, WASH. 2319-2nd Avenue
Seattle Radio Supply, Inc.

SPOKANE, WASH. 611 First Avenue
Spokane Radio Company, Inc.

TULSA, OKLA. 219 S. Boulder
Radio, Inc.

NATIONAL
RADIO PRODUCTS
NATIONAL COMPANY, INC., MALDEN, MASS.

ATLANTA, GEORGIA 430 W. Peachtree Street, N. W.
Wholesale Radio Service Company

FRESNO, CALIFORNIA 2501 Tulare Street
B. J. DeJarnett

FRESNO, CALIFORNIA
Ports Manufacturing Company

LOS ANGELES, CALIF. 729-31 S. Main St.
Pacific Radio Exchange, Inc.

LOS ANGELES, CALIF. 1701 S. Grand Avenue
Radio Television & Supply Company

MEMPHIS, TENN. 223 So. Front St.
Riechman-Crosby Company

MIAMI, FLORIDA 123 Second St., N. E.
Tropical Radio Service

NASHVILLE, TENNESSEE
Braid Electric Company

NEW ORLEANS, LA. 1700 Poydras Street
Shuler Supply Company

OAKLAND, CALIF. 12 & Fallon Streets
Electric Supply Company

PARIS, FRANCE
J. C. Balouzet, De Tigny, 6, Avenue Hoche

SAN DIEGO, CALIF. 744 G Street
Coast Electric Company

SAN FRANCISCO, CALIF. 1452 Market Street
Offenbach Electric Company

SPOKANE, WASH. 611 First Avenue
Spokane Radio Company

RCA de Forest
RADIO TUBES
RCA Radiotron Division of RCA Manufacturing Co., Inc.

ATLANTA, GA. 430 W. Peachtree Street, N. W.
Wholesale Radio Service Company

BIRMINGHAM, ALABAMA 1920 Fourth Ave.
Auto Service Company

DALLAS, TEXAS 107 So. St. Paul Street
Southwest Radio Supply

Where to buy it

A directory of suppliers who carry in stock the products of these dependable manufacturers.

| | | |
|-----------------------|-----------------------------|----------------------------|
| DALLAS, TEXAS | Wilkinson Bros. | 2503 Commerce Street |
| HONOLULU, T. H. | Mutual Telephone Company | |
| KNOXVILLE, TENN. | Radio & Sound Service | 204 W. Clinch Ave. |
| LOS ANGELES, CAL. | Leo J. Meyberg Company | 335 N. Washington Street |
| NASHVILLE, TENN. | Braid Electric Company | |
| OAKLAND, CAL. | E. C. Wenger Company | 1020 Oak Street |
| PORTLAND, OREGON | Harper-Meggee, Inc. | 17th & Irving Streets |
| SAN FRANCISCO, CALIF. | Offenbach Electric Company | 1452 Market Street |
| SAN JOSE, CALIF. | Coast Radio Company | 266 South 1st St. |
| SEATTLE, WASH. | Harper-Meggee, Inc. | Republican & Terry Streets |
| SPOKANE, WASH. | Harper-Meggee, Inc. | S. 122 Lincoln |
| SPOKANE, WASH. | Spokane Radio Company, Inc. | 611 First Avenue |
| TULSA, OKLA. | Radio, Inc. | 219 S. Boulder |



**AMATEUR
RADIO
EQUIPMENT**
RCA Victor Division of RCA Manufacturing Co., Inc.

| | | |
|---------------------|---------------------------------|--------------------------------|
| ATLANTA, GA. | Wholesale Radio Service Company | 430 W. Peachtree Street, N. W. |
| ATLANTA, GA. | Dixie Radio Distributors, Inc. | 144 Walton Street, N. W. |
| DALLAS, TEXAS | Wilkinson Bros. | 2503 Commerce Street |
| DENVER, COLO. | Auto Equipment Company | 14th at Lawrence St. |
| LOS ANGELES, CALIF. | Pacific Radio Exchange, Inc. | 729-31 South Main St., |
| MEMPHIS, TENNESSEE | Riechman-Crosby Company | 223 South Front Street |
| PORTLAND, OREGON | Stubbs Electric Company | 33 N. Park Avenue |
| SAN FRANCISCO, CAL. | San Francisco Radio Exchange | 1284 Market Street |
| SAN JOSE, CALIF. | Coast Radio Company | 266 South 1st St. |
| SEATTLE, WASHINGTON | Seattle Radio Supply, Inc. | 2319-2nd Avenue |
| SPOKANE, WASH. | Spokane Radio Company, Inc. | 611 First Avenue |
| TULSA, OKLA. | Radio, Inc. | 219 S. Boulder |

Microphone Headquarters



SHURE BROTHERS COMPANY
CHICAGO, ILLINOIS

| | | |
|---------------------|---------------------------------|--------------------------------|
| ATLANTA, GA. | Wholesale Radio Service Company | 430 W. Peachtree Street, N. W. |
| KNOXVILLE, TENN. | Radio & Sound Service | 204 W. Clinch Ave. |
| LITTLE ROCK, ARK. | Beem Radio Company | 409 W. 3rd St. |
| SAN FRANCISCO, CAL. | Offenbach Electric Company | 1452 Market Street |
| SEATTLE, WASH. | Seattle Radio Supply, Inc. | 2319-2nd Avenue |
| SPOKANE, WASH. | Spokane Radio Company | 611 First Ave. |
| TULSA, OKLA. | Radio, Inc. | 219 S. Boulder |



**TRIPLET
INSTRUMENTS**

| | | |
|---------------------|---------------------------------|--------------------------------|
| ATLANTA, GA. | Wholesale Radio Service Company | 430 W. Peachtree Street, N. W. |
| DALLAS, TEXAS | Southwest Radio Supply | 107 S. St. Paul Street |
| LITTLE ROCK, ARK. | Beem Radio Company | 409 W. 3rd St. |
| SAN FRANCISCO, CAL. | Offenbach Electric Company | 1452 Market Street |
| SPOKANE, WASH. | Spokane Radio Company | 611 First Avenue |
| TULSA, OKLA. | Radio, Inc. | 219 S. Boulder |

United
TRANSMITTING TUBES

| | | |
|---------------------|------------------------------|--------------------|
| LOS ANGELES, CALIF. | Pacific Radio Exchange, Inc. | 731 S. Main St. |
| RENO, NEVADA | J. D. Mariner Music House | Arcade Building |
| SEATTLE, WASH. | Seattle Radio Supply, Inc. | 2319 Second Avenue |
| SPOKANE, WASH. | Spokane Radio Company, Inc. | 611 First Ave. |

The Revised R-S-T System

(For Your Convenience)

SINCE the publication of Mr. Braaten's suggestion that the "strength" part of the R-S-T scales be changed for those who prefer a nine division scale, many letters have been received approving the idea—and a substantial number of users have put the nine-point scale into immediate use, without even a suggestion to do so, to show their preference. There is no doubt that the majority of R-S-T users approve the thought. In accordance with this idea we hasten to reprint the whole R-S-T system in convenient form so you can cut this out and keep it in your operating position. The completeness and brevity of the R-S-T method of reporting continue to win it friends and users, and if we all adopt the habit of using the nine-point strength scale immediately, all confusion of definitions may be avoided.

R-S-T READABILITY

1. Unreadable
2. Barely readable—occasional words distinguishable
3. Readable with considerable difficulty
4. Readable with practically no difficulty
5. Perfectly readable

SIGNAL STRENGTH

| | <i>Old Scale</i> |
|-------------------------------------|----------------------|
| 1. Faint—signals barely perceptible | 1 |
| 2. Very weak signals | 2 |
| 3. Weak signals | 3 |
| 4. Fair signals | 4 |
| 5. Fairly good signals | 5 |
| 6. Good signals | 6 |
| 7. Moderately strong signals | 7 |
| 8. Strong signals | 8 |
| 9. Extremely strong signals | 9 |

STONE

1. Extremely rough, hissing note
2. Very rough a.c. note—no trace of musicality
3. Rough, low-pitched a.c. note—slightly musical
4. Rather rough a.c. note—moderately musical
5. Musically modulated note
6. Modulated note—slight trace of whistle
7. Near d.c. note—smooth ripple
8. Good d.c. note—just trace of ripple
9. Purest d.c. note

If the note appears to be crystal-controlled, simply add an X after the appropriate number.

Furnished All Amateurs by The American Radio Relay League

Atlantic Division Convention

(Continued from page 108)

from the convention) were thankful for that, but they returned to the hotel rather moist.

During the evening some of the phone group drove to Rome, N. Y., where Harold Lingle, W8OMJ had provided lounging room for the 40-odd 'phone men assembled. At convention headquarters contests with new ideas were participated in by the gang that had registered the first day. Hamfesting followed the stunts until the various amateur radio problems had all been settled before dawn and slumber overcame even the most enthusiastic. During the day delegates registered from all over the division with a delegation present from Canada.

Saturday morning the Atlantic Division Radio-Phone Assn. assembled at 9 with Dr. Burton T. Simpson, W8CPC, chairman-president. After the meeting prizes were drawn by association members. During this meeting McElroy, speed artist was conducting a code-speed contest in another room. This was won by R. H. Lucia. The U.S.N.R. had their meeting and Roy C. Corderman, chief radio aide, conducted the A.A.R.S. group. A traffic meeting with S.C.M.s and other officials present was not well attended.

During the afternoon half-hour talks were given and exceptionally well attended. The speakers included Richard Purington, W2ICU of Raytheon Production Corp.; Roy C. Corderman, W3ZD; Lawrence Geno, W8PE; Clark Rodimon, W1SZ; Robert Graham, W8LUQ; and John Reinartz, W1QP. The afternoon talks were topped off with a demonstration by McElroy of high-speed reception. "Mac" couldn't do better than 68 per that afternoon.

With a few minutes free the hamfesting once more took precedence before the banquet. Starting on time the banquet ballroom was packed with around 600 in attendance. Entertainment was provided by an orchestra which Sam Woodworth, W8KIR had kindly sent over. After dinner President Ernest Wood, W8CYT of the Central New York Radio Club, spoke and introduced Toastmaster Dr. Burton T. Simpson of Buffalo, Director E. C. Woodruff, W8CMP, outlined the Cairo Committee problems. He was followed by three other directors, Central Division's Roberts; Hudson Division's Hill and New England Division's Bailey. A.R.R.L. Fieldman Hebert spoke representing the League. John Reinartz spoke briefly. T. A. McElroy and Chairman Joseph L. Smith were the last speakers.

The prizes were distributed and the official convention came to a close with everyone agreeing the banquet had been one of the most interesting and orderly affairs ever attended. This was proper with the presence of four League directors in attendance.

Adjournment was made before midnight and any unsettled or unfinished business was taken to various rooms. Judging by appearances four hours later business was still in full sway.

—W8CYT

HAM-ADS

(1) Advertising shall pertain to radio and shall be of nature of interest to radio amateurs or experimenters in their pursuit of the art.

(2) No display of any character will be accepted, nor can any special typographical arrangement, such as all or part capital letters be used which would tend to make one advertisement stand out from the others.

(3) The Ham-Ad rate is 15c per word, except as noted in paragraph (6) below.

(4) Remittances in full must accompany copy. No cash or contract discount or agency commission will be allowed.

(5) Closing date for Ham-Ads is the 25th of the second month preceding publication date.

(6) A special rate of 7c per word will apply to advertising which, in our judgment, is obviously non-commercial in nature and is placed and signed by a member of the American Radio Relay League. Thus, advertising of bona fide surplus equipment owned, used and for sale by an individual or apparatus offered for exchange or advertising inquiring for special equipment, if by a member of the American Radio Relay League takes the 7c rate. An attempt to deal in apparatus in quantity for profit, even if by an individual, is commercial and takes the 15c rate. Provisions of paragraphs (1), (2), (4) and (5) apply to all advertising in this column regardless of which rate may apply.

Having made no investigation of the advertisers in the classified columns, the publishers of *QST* are unable to vouch for their integrity or for the grade or character of the products advertised.

QUARTZ—Direct importers from Brazil of best quality pure quartz suitable for making piezo-electric crystals. Diamond Drill Carbon Co., 719 World Bldg., New York.

METER and Microphone Repairs. Low prices. Estimates free. Quick repair service—broadcasting equipment, all electrical instruments. Sound Engineering Corp., 2200 Kinzie, Chicago.

RADIO engineering, broadcasting, aviation and police radio, servicing, marine and Morse telegraphy taught thoroughly. All expenses low. Catalog free. Dodge's Institute, Byrd St., Valparaiso, Ind.

1000W General Electric transformers, 1100-2200-4400 each side center on 110. Sold hams eight years. \$13.50. Dawson, 5740 Woodrow, Detroit.

QSLs—W2BN, Helmetta, N. J.

ENGRAVING instrument panels exclusively since 1925. A. L. Woody, 189 West Madison St., Chicago, Ill.

GENERAL Electric dynamotors, 24/750 volts, 150 watts with filter \$25. Two machines for 1500 volts, \$40. Westinghouse 27 1/2 /350 80 mills \$10. 6-15 volt 600 watt with propeller, \$10. 500 watt 500 cycle, 110-220 volts, \$7.50. Henry Kiensie, 501 East 84th St., New York.

NATIONAL—Hammarlund, Patterson used sets, 60% off list. W3DQ, 405 Delaware Ave., Wilmington, Del.

QSLs, SWLs, W8ESN, 1827 Cone St., Toledo, Ohio.

HAM apparatus to sell or trade? List your swaps with us. Amateur Exchange, 6341 Broadway, Chicago.

HANDBOOK by Radio Magazine! \$1 from W8DED.

QSL's! World's finest! Samples? Stamp. W8DED, Holland, Michigan.

QSLs—5 years printing QSL's. Samples. W2AEY.

QSLs, Free Samples. Printer, Corwith, Iowa.

QSLs—125 for \$1.00—W8RW, Bluffton, Ohio.

.00035 Variable condensers, 3 for \$1.00, W8RW, Bluffton, Ohio.

TRADE nearly new eight inch Jensen permanent magnet speaker in cabinet for good receiver. AC preferably. W6BEZ.

WANTED—3XM QSL card 1922-1925 as souvenir. W2GVZ (ex "J" of 3XM).

FIRST \$250. takes 400 watt commercial built phone transmitter complete with coils, crystal, microphone and tubes. Two 203A's final stage with class B modulation. Also have Comet Pro Ave crystal all coils and speaker \$30. J. D. Avery IIVI, 65 Woodbine Street, Auburndale, Mass.

WANTED—1000 volt motor generator or generator. W8DRA. QSL cards, two color, cartoons, message blanks, stationery, snappy service. Write for free samples to-day. W1BEF, 16 Stockbridge Ave., Lowell, Mass.

SUPER Sky-Rider, Xtal, Ten Meters, used 90 days. New price \$88.50. Splendid condition. \$49.50. W5EIB.

W9AIO complete 800 watt cw 400 watt fone transmitter for sale. Write for information.

NEW 204A used 204A Lincoln superhet, eleven tubes, 6VDC. Make best cash offer. Swaps considered. W9CP.

QSLs, 300 one color cards \$1.00. Samples, 2143 Indiana Avenue, Columbus, Ohio.

QSLs by Maleco. Finest. Free samples. Maleco, 1512 Eastern Parkway, Brooklyn, New York.

MG sets, 115 volt AC to same DC; output .27 ampere. \$20.00. N. Morris, 3129 Warder St., N. W. Washington, D. C.

QSLs. Samples. W8JSL Press, 221 Chaddock Av., Buffalo, N. Y.

RELAYS—keying, control, overload—50¢, \$1. R. White, 11030 Hermosa, Chicago.

TRANSFORMERS and chokes—new—Hilet low resistance type, unmounted only at large savings. Also meters and miscellaneous material. Send stamp for lists. Leitch Radio, West Orange, N. J.

BUY sell or swap. W4DND, Winterville, Ga.

W9LBI selling out. 1 kilowatt Thordarson Transformer for 12 dollars represents only one bargain. Write for list. 812-11th Avenue North, Fargo, N. D.

MILLIAMMETERS—triple range Jewells. W9SKF, 1237 "C" St., Lincoln, Nebraska.

FOR sale—three stage sixty watt crystal transmitter. Commercial looking. Like new. \$15.00. Write for photo. W8HVX, 2903 Cypress, Cleveland.

BEST offer takes slightly used FB7A, tubes, 80 meter coils. W9MBX, 2533 So. 28th St., Milwaukee, Wisc.

CRYSTALS—Y cut, 160-80. Within 5 kcs. \$1.00 postpaid. W9JKN, Montrose, Chicago.

METERS repaired properly at reasonable rates. Electrical Instruments Laboratories, 1542 Hertel Avenue, Buffalo, N. Y.

TELEPLEXES, Omnigraphs, meters, Vibroplexes, receivers. Bought, sold, traded. Ryan Radio Co., Hannibal, Mo.

ARTISTIC QSLs. T. Vachovetz, Elmsford, N. Y.

CRYSTALS: unconditionally guaranteed precision crystals at amateur prices. X-cut 80-160 meters within 5 kilocycles \$2.00; exact frequency \$3.00; 40 meters within 20 kilocycles \$3.00. AT cut crystals 80-160 meters 5 kilocycles \$4.00. New G.R. mounting or socket type holders \$1.00. Get real results by using these better crystals. Gentry Laboratories, 803 West Maple, Independence, Missouri.

TRANSMITTERS built. Your parts or new. Guaranteed 866's, \$1.39. Panels, chasses, transformers, tubes. Write Howard Radio, 5648 Race Ave., Chicago.

VIBROPLEXES, rebuilt \$5-\$7. New large base bugs \$9. Leycard, 28 Circuit, Roxbury, Mass.

AUTOMOBILE call letter plates. Steel. 6" X 12". Colors optional. 60¢ pair. W9AIN.

CRYSTALS: Zero cut. Guaranteed to compensate at near zero without oven control. Your approximate frequency, 80 or 160 meters \$1.85. Ordinary zero cuts \$1.35 postpaid. Plug-in holders 75¢. Fisher Laboratory, 4522 Norwood Street, San Diego, California.

QUARTZ—Direct importers from Brazil pure quartz suitable for piezo-electric crystals. G. L. Fisher, 4522 Norwood, San Diego, Calif.

EIMAC, Raytheon, Cardwell, Biley, RME9-D, Super Sky-rider, Sargent, Patterson. Trade in your receiver. Southern Radio Supply, 209 Scott, Little Rock, Ark. Att'n W5VK.

CRYSTALS: unconditionally guaranteed, 160-80 meters within 10 kilocycles Y-cut \$1, X \$1.35, A \$1.50, within 1% Y \$1.25, X \$1.50, A \$1.75. 40 meters within 20 kilocycles Y-cut \$2, within 1% \$2.50. Blanks Y-cut 3-\$1.25, oscillating 60¢ each. I.F. 465, 500, 525 kilocycles within 1% \$2.00. Wright Laboratory, 5859 Glenwood, Chicago, Illinois.

1000 watt transformer—2000, 3000 each side \$13.50—W3CGA.

BEAUTIFUL call letters—cast aluminum with border same weight as letters—letters 2 1/2" high and 1/4" thick—base of letters and border finished black enamel or aluminum—face polished aluminum—call letters cast one piece for automobile or transmitter, \$2.00. 2-1/2" individual letters and figures 35¢ each, postpaid anywhere in U. S. Letters bored and tapped on back for individual mounting with 1/4" machine screws 5¢ each extra. W4CJH Hickory, N. C.

RECEIVERS—new and used sold and traded in. Hammarlund, Nationals, RME9D, Sky rider. Schwarz Radio Service, 15 Lawrence Ave., Dumont, N. J.

CLASS B transformers—Universal for two or four 46s, 210s, 800s, RK18s, etc., \$7.75 pair postpaid. 70 watts audio from 46s, 100 watts from 10s. Write for details. W8UD, Douglas, Mich.

SELL 8UD transformers, Triplett O-5RF 282-A, 802. Want 860's 861 meters, filter. W7EMQ.

THE new Super Skyriders. W8IV Argyle, New York.

WANTED—used Patterson or Sky rider. W8HZC 123 Elm-hurst, Detroit.

EIMAC 50T unused. Weston Meter Model 506-0-7-140 volts. Best offer. W8NRR, Millvale, Pa.

QSLs. The finest obtainable, at the lowest price. 75¢ per hundred for two colors. Stationery, etc. W2FJE, 145 Lafayette Avenue, Brooklyn, N. Y.

ELECTROGRAPH—design, rewind your own power transformers. Direct reading slide rule gives turns, current capacity of wire, etc. Price \$1.00. S. & A. Co., 4715 Eichorn Ave., Cleveland, Ohio.

WANTED—good used crystal filter receiver covering 1.5 to 30MC. Chalkey, 10 East 53rd, New York.

CRYSTALS:—zero coefficient "V" cut. Superior to "At." 1715-4000 within five kilocycles. Ten cycle coefficient, \$2.25. Four cycle coefficient, \$3.25. "X" cut, \$1.95. Forty meter, \$2.75. Request literature. Ham Crystals, 1104 Lincoln Place, Brooklyn, N. Y.

NATIONAL ACSW3, 40, 80 coils, tubes. New. \$18.00. W2BQ.

SELL: FBXA receiver with preselector stage and 2½-volt a.c. tubes, includes 8 sets coils, 10, 20, 40, 80, 160-meter brand spread. Also B, C, D coils. Looks like new, an unusual value at \$55.00; Dynatron frequency meter, six inch vernier dial. Weston meter all in hinged cabinet box like photo pages 16 and 18 Oct. 1930 QST, \$18; 175 watt 12 v ctr-tapped filament transformer \$4; 750 watt 1500 volt UP1016 transformer, with 10½v fil. windings, \$12.50; 110-220v (and in between) auto transformer \$4; 16-94 ohm Elkon reactor, ¾ amp., heavy ¼" th. cast aluminum box with partitions 14" x 12½" x 8", 203A (new), 860 (used), a few 1 and 2 mfd. 2,000 volt paper condensers, tested for capacity and leakage, reasonable, make offer; Temperature control box with Centigrade thermometer, and thermo-regulator as shown Dec. 1930 QST, page 41, holds 3 crystals, could hold 6, \$20. Handy, c/o ARRL, West Hartford, Conn.

SELL new RCA 852 \$13.50 W1BZO.

GUARANTEED crystals, 80-160 meters, \$1.00 postpaid. 465, \$2. Herbert Addington, 2252 North Leclair, Chicago.

CALLBOOKS—new Fall 1935 Radio Amateur Call Book, thousands of late W and VE calls, many pages of new DX QRAs and important changes in prefixes, is yours for \$1.25, or one year (four issues) for \$4.00. (In foreign countries \$1.35 and \$4.35, postpaid.) W9FO, 610 S. Dearborn, Chicago.

LOOK, perform, like a million. New welded relay racks, panels. QST specification power equipment. Edison B Batteries. Rectifier Engineering Service, 4837 Rockwood Rd., Cleveland, Ohio.

GUARANTEED crystals, 160-80 meter. Less than 1", within ten kilocycles, \$1.35. 1" square, within two kilocycles \$2.25. Blanks, odds and ends, five for \$1.00. Holders \$1.00. William Threm, W8FN, 4021 Davis Ave., Cheviot, Ohio.

RAW quartz, finished crystals, molded holders as true as a die, folder free. You will be surprised. Faberadio, Sandwich, Ill.

RADIO operating and servicing taught in short practical shop courses with personal instruction on actual equipment. Complete studio, large modern B.C. transmitter. Quality for amateur, first class radiophone or second class radiotelegraph government license. Also public address, sound and television in well equipped shops and laboratories. Special course in electric refrigeration and air conditioning. New live field combining excellently with radio. Send for free book with full details. Coyne Electrical & Radio School, Dept. 75-5K, 500 So. Paulina St., Chicago, Ill.

W9ADN crystals. All new high activity types. Substantially zero temperature coefficients—40, \$3.75; 80 AT, \$4. Low coefficient 80, \$2.50.

INTRODUCTORY offer. One order to an individual. Send \$1. and call letters for 100 two color modern QSL cards and six F.M.C. porcelain case mica low loss transmitting and receiving condensers. Any capacity up to .006 mfd. 5% capacity tolerance 2,000 volt test. Actually a \$7.50 value for \$1. Capacity color chart included. Filtermatic Mfg. Company, Tacony, Philadelphia, Penna.

COMPLETE station, W1BML, for sale in parts. Write to W1ARK, East Providence, R. I. for list, enclose stamp. Wish to buy used Hammarlund Comet Pro, crystal and Peak preselector and coils best possible price, FB condition. Edgar Docherty, 196 Congress Ave., Providence, R. I.

ASTATIC

CRYSTAL MICROPHONES AND PICKUPS

Guaranteed instruments, known for their quality, dependability and ruggedness. Extensively used in both Professional and Amateur fields. Send for your literature today!

ASTATIC MICROPHONE LABORATORY INC., YOUNGSTOWN, OHIO

NEWARK'S SETS FOR EVERY AMATEUR

Newark's deferred payment plan, available to everyone in the U.S.A. makes it easy for you to own a

**NATIONAL HRO
HAMMARLUND PRO
HAMMARLUND SUPER PRO
SUPER SKYRIDER
RCA ACR-136
RME9D**

All of these sets on display at our Chicago store, 226 W. Madison St. Come in or write for details.

NEWARK BARGAINS!!

Oil Filled — Oil Impregnated Filter Condensers

| | |
|-------------------------------------|--------|
| 2 mfd. 1500 V. DC 4½ x 3¼ x 1¼..... | \$1.20 |
| 2 mfd. 2000 V. DC 4¾ x 5 x 1..... | 1.50 |
| 6 mfd. 1500 V. DC 5 x 3¾ x 2½..... | 2.25 |
| 8 mfd. 2000 V. DC 4½ x 5 x 3..... | 2.75 |

Newark Paper Filter Condensers

These condensers are canned with porcelain Standoffs Every One Guaranteed!

| | |
|------------------------|-----|
| 1 mfd. 1000 V. DC..... | 56c |
| 1 mfd. 1500 V. DC..... | 66c |

NEWARK ELECTRIC COMPANY

"FASTER SERVICE — BETTER BARGAINS"
226 W. Madison Street, Dept. Q
Chicago, Illinois

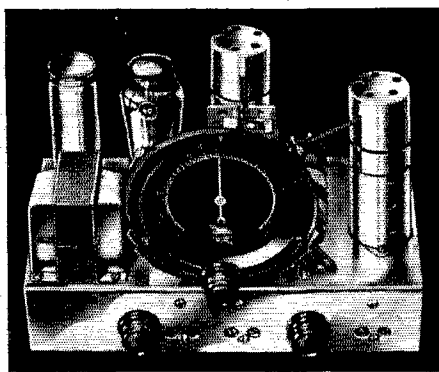

GET MORE DX

The New Miller Preselector

Here is a simple, inexpensive and really practical Preselector. It will give you more distance and sensitivity with lower noise and absolutely no images. The coils cover the full range from 12 to 200 meters. Additional features include built-in power supply, two stages of tuned R.F., efficient output circuit, and single wire or doublet antenna.

"Build it Yourself" in Kit Form, No 302 Coil Kit \$4.80

Or if you prefer to buy your equipment "tailor made" here is a real opportunity. Complete with tubes and metal cabinet \$24.00



At Your Dealer or Write

J. W. MILLER CO.
5917 SOUTH MAIN STREET, LOS ANGELES, CAL

Your Nearest Dealer Is Your Best Friend

Your nearest dealer is entitled to your patronage. You can trust him. He is equipped with a knowledge and understanding of amateur radio. He is your logical and safe source of advice and counsel on what equipment you should buy. His stock is complete. He can supply your needs without delay. His prices are fair and consistent with the high quality of the goods he carries. He is responsible to you and interested in you.

Patronize the dealer nearest you—You can have confidence in him

ALLENTOWN, PENNSYLVANIA

Radio Electric Service Co.
1024 Hamilton Street
Complete stocks transmitting equipment

BALTIMORE, MARYLAND

Radio Electric Service Co.
303 W. Baltimore Street
Everything for the amateur

BIRMINGHAM, ENGLAND

Radio Mart
19 John Bright Street
Drop in and meet Bill Nightingale—G5NI

BROCKTON, MASSACHUSETTS

Ware Radio Supply Co.
913 Centre Street
Hammarlund, Triplett, Ohmite, Raytheon, Bliley, Browning Kits

BUFFALO, NEW YORK

Dymac Radio
216 E. Genesee St. — Tel. Cl. 2080
Complete Stock Amateur Parts — Standard Discounts — W8AWK

BUFFALO, NEW YORK

Kronson Service Company
143 East Genesee Street
Western New York's largest wholesale distributors — W8EHF

ERIE, PENNSYLVANIA

Jordan Radio Laboratory
2512 Peach Street
Amateur, service parts, including Bliley, National, Raytheon. W8CXG

MANCHESTER, NEW HAMPSHIRE

Radio Service Lab. of N. H.
1008 Elm Street — Tel. 218-W
Branches — Portland, Me. and Barre, Vt.

MONTREAL, CANADA

Canadian Elec. Supply Co., Ltd.
285 Craig St., W.
Quality parts and equipment for discriminating buyers

NASHVILLE, TENNESSEE

Braid Electric Co.
Ham Supplies—Replacement Parts
RCA, National, Hammarlund, and other leaders

PHILADELPHIA, PENNSYLVANIA

Consolidated Radio Corp.
612 Arch Street
Ham receivers, Transmitting tubes, Collins transmitters, etc.

PHILADELPHIA, PENNSYLVANIA

Radio Electric Service Co., Inc.
N. E. Cor. Seventh & Arch Sts.
All nationally-advertised lines in stock

PHILADELPHIA, PENNSYLVANIA

Eugene G. Wile
10 S. Tenth Street

Complete Stock of Quality Merchandise

PITTSBURGH, PENNSYLVANIA

Cameradio Company
601-3 Grant Street
"Ham" Headquarters for Pennsylvania-Ohio-W. Virginia

PROVIDENCE, RHODE ISLAND

W. H. Edwards Co.
32 Broadway
National—Hammarlund—RCA—and other leaders

PROVIDENCE, RHODE ISLAND

Kraus & Company
89 Broadway
Everything for the amateur and serviceman

ROCHESTER, NEW YORK

Radio Service Shop
244 Clinton Avenue, North
Complete stock amateur-BCL parts. Standard discounts. W8NUC

SYRACUSE, NEW YORK

Roy C. Stage, W8IGF
Complete stock of standard Ham & BCL parts
Standard Discounts. Free technical service

WASHINGTON, D. C.

George's Radio Co.
816 F Street, N.W.
Washington's largest distributor of radio parts

WHEELING, WEST VIRGINIA

Cameradio Company
30 Twelfth Street
Complete stock of amateur Equipment at standard discounts

You Are Protected When You Buy From QST Advertisers

“Advertising for QST is accepted only from firms who, in the publisher’s opinion, are of established integrity and whose products secure the approval of the technical staff of the American Radio Relay League.”

Quoted from QST’s advertising rate card.

Every conceivable need of a radio amateur can be supplied by the advertisers in QST. And you will know the product has the approval of the League’s technical staff.

For Your Convenience QST’S INDEX TO ADVERTISERS IN THIS ISSUE

| | |
|---|--------------------|
| Aerovox Corporation | 85 |
| American Power Tool Company | 87 |
| Amperite Corporation | 99 |
| Astatic Microphone Company | 108 |
| A.R.R.L. Binder | 80 |
| Calculator | 4, 86, 88 |
| Handbook | 90 |
| License Manual | 84 |
| Log Book | 103 |
| How to Become | 99 |
| Birnbach Radio Company | 89 |
| Biley Electric Company | 85 |
| Bud Radio, Inc. | 93, 94 |
| Burgess Battery Company | 112 |
| Burton-Rogers Company | 95 |
| Candler System Company | 101 |
| Capitol Radio Engineering Institute | 98 |
| Central Radio Laboratories | 74 |
| Cohen’s Sons, I. S. | 93 |
| Collins Radio Company | Cov. 3 |
| Communications Products, Inc. | 97 |
| Cornell-Dubilier Corporation | 87 |
| Coto Coil Company | 95 |
| Delaware Radio Sales Company | 93, 95, 102 |
| Deutschmann Corporation, Tope. | 92 |
| Dodge’s Institute | 95 |
| Eby, Inc. Hugh H. | 101 |
| Eitel-McCullough, Inc. | 100 |
| Electrad, Inc. | 98 |
| Electric Soldering Iron Company | 83 |
| Electro-Voice Manufacturing Company | 91 |
| Filtermatic Manufacturing Company | 102 |
| General Electric Company | 77, 87 |
| General Radio Company | 76 |
| Gross Radio, Inc. | 79 |
| Gulf Radio School | 97 |
| Hallcrafters, Inc. The | 5 |
| Hammarlund Manufacturing Company | 1 |
| Harvey Radio Laboratories | 96 |
| Henry Radio Shop | 85 |
| Hinds & Edgarton | 7 |
| Hipower Crystal Company | 87 |
| Instructograph Company | 83 |
| International Resistance Company | 89 |
| Jefferson Electric Company | 8 |
| Leeds | 111 |
| Lefebvre Corporation | 99 |
| Littelfuse Laboratories | 99 |
| Marine Radio Company | 2, 6 |
| Massachusetts Radio School | 93, 94 |
| McGraw Hill Book Co. | 82 |
| Miller Company, J. W. | 108 |
| National Company | 73, Cov. 3, Insert |
| Newark Electric Company | 108 |
| New York V. M. C. A. | 102 |
| Northern Ohio Laboratories | 83, 95 |
| Offenbach Electric Company | 7, 94 |
| Ohmite Manufacturing Company | 99 |
| Pioneer Gen-E-Motor Corp. | 91 |
| Port Arthur College | 91 |
| Precision Piezo Service | 93, 94 |
| Premier Crystal Laboratories | 91 |
| Radio Accessories | 6 |
| Radio Laboratories | 93 |
| Radio Receptor Corporation | 97 |
| Radio Shack | 89, 93 |
| Radio Supply Company | 95 |
| Radio Transceiver Laboratories | 99 |
| Raytheon Mfg. Co. | 101 |
| RCA Institutes, Inc. | 99 |
| RCA Radiotron Company | Cov. 4 |
| RCA Victor Company | 81 |
| Rider, John F. | 100 |
| Scientific Radio Service | 97 |
| Shuler Supply Company | 95 |
| Shure Brothers Company | 96 |
| Signal Electric Manufacturing Company | 89 |
| Sprague Products Company | 87 |
| Standard Transformer Company | 83 |
| Teleplex Company | 95 |
| Thordarson Electric Manufacturing Company | 102 |
| Triplett Electrical Instrument Company | 78 |
| Turner Company | 101 |
| United Radio Manufacturing Company | 91 |
| Weston Electrical Instrument Corporation | 75 |
| Wright-DeCoster, Inc. | 97 |

LEEDS Leads the Fall Radio Parade

NATIONAL—type TMC transmitting condensers; double spaced, polished plates isolantite insulation, 50 mmf. — \$2.40; 100 mmf. — \$2.55; 150 mmf. — \$2.75; 300 mmf. — \$3.30. We carry the complete National line of parts and sets including the SW-3 — FB-7A and AX and the HRO at 40% off list.

LEEDS COPPER WIRE SPECIALS

| Size No. 18 16 14 12 10 8 | ENAMELED HARD DRAWN SOFT DRAWN | |
|---|-------------------------------------|------------------------|
| | TINNED Ideal for Antennas | TINNED It Stretches |
| | | \$.25 |
| | \$.30 | .30 |
| | .40 | .40 |
| | .55 | .55 |
| | .85 | .85 |
| | 1.35 | .85 |
| | It Doesn't Stretch For Coil Winding | |

Prices quoted above in 100-foot lengths.

Larger quantities in one piece are available.

Highest quality stranded copper wire with rubber insulation and braided tinned copper shield over all.

No. 20 — 35c; No. 18 — 40c; No. 16 — 45c; No. 14 — 50c. Above prices are for 25-foot lengths. Prices lower on larger quantities.

SPECIAL BARGAINS in used equipment carry LEEDS regular guarantee of 100% satisfaction

WESTERN ELECTRIC 1-mfd 500 v. condensers.....25c
2 mfd 500 v.....35c
40 Henry 60 ma 850 ohm chokes.....49c
Audio Transformers 3:1 ratio.....49c
General Radio 310 dials, 2 3/4".....25c
General Radio .0005 variable condensers.....75c
Only \$41.40 — Tobe Amateur communication receiver kits in stock. Bulletin on this outstanding receiver mailed on request.

LEEDS 4-B Transmitter delivering 120 watts output, with band switching on 1.7 — 3.5 — 7.0 and 14.0 mc. \$120.00
Suppressor grid or plate modulation units available. Dope sheet on request.

TRIMM 2,000 ohm phones \$1.80. 4,000 ohm.....\$2.25
TRIMM featherweight \$5.88. **FROST** 2,000 ohm.....\$1.45
FROST 3,000 ohm \$1.65. **DX** 20,000 ohm imp.....\$2.65

WESTERN ELECTRIC type P-11.....\$3.95

PIEZO Astatic crystal microphones; type D-104.....\$13.23

SHURE model 70-H crystal microphone.....\$13.23

AMERICAN type EL microphone; list \$10. Special.....\$4.45

Chrome plated swivel top desk milke stand. Special.....\$3.95

NA-ALD black crystalline Lacquer for finishing metal or wooden panels; 2 oz. can — \$2.1. Pint can.....\$7.75

LEEDS wet processed glazed porcelain antenna insulators 1" diameter, 7" long — 25c. 12" long — 35c. 20" long — 50c.

Airplane type strain insulators 4c each. 10 for 35c.

LEEDS type 2 relay; adjusted to operate between 10 and 150 ma. D.C. two contact arms with make or break contacts 350 ohms resistance; price.....\$2.00

GUARDIAN keying relay, 5 to 16 volts A.C. or D.C.....\$3.24

" break in relay; D.P. D.T. 110 v. A.C.....\$4.41

GUARDIAN non-adjustable overload relays for 250 mils or for 500 mils; either type, special \$4.41. **GUARDIAN** adjustable type overload relay from 150 to 500 mil.....\$7.06

Type 1 Midget Relay, in our Bulletin No. 73.....29c

LEEDS CRYSTALS — 160 and 80 meter X cut crystals; plus or minus 1 KC of specified frequency \$2.25. AT cut \$5.00. 7 mc. plus or minus 2 KC of specified frequency; X cut \$3.25. AT cut \$6.50. New Hill all brass adjustable holder, ideal for 40 meter crystals.....\$1.65

Monitor dustproof crystal holder fits UV socket.....\$1.00

The new RCA type TMV-135-A crystal holder.....\$2.50

Navy type Telegraph Key, List \$3.60. Navy knob — 3/4" Tungsten contacts. Special at \$1.15. With regular knob 95c.

Leeds transmitting key, on wooden base, special.....\$1.65

Navy knobs.....\$1.50

MULLER Pee-Wee clips, all copper, each 7c.

TRIPLETT METERS 2" diameter, bakelite case; all ranges from 5 mills \$2.94; 3 1/2" diameter, all range \$3.75.

RCA receiving tubes; complete line; 40% and 2% off list.

SYLVANIA receiving tubes; we have the complete line; 50% discount from list.

O-MAX coil dope, 2 oz. can.....25c

RCA Choke; 18 Henry, 100 mil, 125 ma.....\$4.49

Bases and demi-bases made of 20 gauge steel. Described fully in our Bulletin No. 73.

Demi-Base Units

8 x 8 1/2 x 2 4 lbs. Shipping Weight Price \$.55

10 x 8 1/2 x 2 5 lbs. Shipping Weight Price \$.65

Full Bases

4 x 17 x 2 5 lbs. Shipping Weight Price \$.75

8 x 17 x 2 7 lbs. Shipping Weight Price \$ 1.00

10 x 17 x 2 7 lbs. Shipping Weight Price \$ 1.20

LEEDS LEADS as the only distributor in the country, handling **GENERAL RADIO** Amateur accessories and laboratory apparatus. *Bulletin No. 936 mailed on request.*

GENERAL RADIO coil forms type 677-U price 50c; type 677-Y price 75c. G. R. amateur accessories always in stock. **GENERAL RADIO** dials, with fluted knobs 4" — \$1.50; 3 1/2" — \$1.25; 2 3/4" — \$1.00.

LEEDS PLATE TRANSFORMERS, PRIMARY 115 VOLTS A. C. 50/60 CYCLES

LB-10 450 each side of center at 150 MA; 5V-3A; 2 1/2 V-10A; LB mtg.....\$3.25
LA-2 500 each side of center at 200MA; 2 1/2 V.C.T. 14A; 5 V.C.T. 3A; LA mtg.....\$4.00
LA-3 600 each side of center at 200MA; 2 1/2 V-10A; 7 1/2 V-3A; 5V-3A; LA mtg.....\$5.00
LA-4 800 each side of center at 150MA; LA mtg.....\$3.75
LA-5 800 each side of center at 250MA; LA mtg.....\$5.50

LEEDS SMOOTHING CHOKES

LB-1 12 H., 200 MA; D.C. res. 140 ohms, LB mtg.....\$2.50
LA-30 12 H., 300 MA; D.C. res. 105 ohms, LA mtg.....\$3.75
LA-50 12 H., 500 MA; D.C. res. 70 ohms, LA mtg.....\$6.50

LEEDS INPUT SWINGING CHOKES

LB-2 5/25 H., 200 MA; D.C. res. 140 ohms LB mtg.....\$2.50
LA-40 5/25 H., 300 MA; D.C. res. 105 ohms LA mtg.....\$3.75
LA-60 5/25 H., 500 MA; D.C. res. 70 ohms LA mtg.....\$6.50

LEEDS FILAMENT TRANSFORMERS, PRIMARY 115 VOLTS A. C. 50/60 CYCLES

LA-15 2 1/2 V.C.T. 12A; 5000 V. insulation; 10 V.C.T. 6 1/2 A. LA mtg.....\$4.00
LA-16 5 V.C.T. 20A; 7,000 V. insulation; LA mtg.....\$3.75
LA-17 5 V.C.T. 20A; 10,000 V. insulation; LA mtg.....\$5.00
LB-12 2 1/2 V.C.T. 12A; 7,000 V. insulation; LB mtg.....\$2.25
LB-13 7 1/2 V.C.T. 6 1/2 A; 5,000 V. insulation; LB mtg.....\$2.50
LB-14 10 V.C.T. 6 1/2 A; 5,000 V. insulation; LB mtg.....\$2.50
LB-15 5 V.C.T. 3A; 5 V.C.T. 6A; 5,000 V. insulation LB mtg.....\$2.50
Westinghouse 10 and 15 amp watt hour meters; for use on 110 or 220 volts, 60 cycles.....\$2.50
General Electric Neon tubes, 1/4" — 1" watt; each.....29c
PAWOOD circle cutters are ideal for making large holes in metal panels. No. 2.....\$1.18; No. 5.....\$1.88.

BAKELITE PANELS AT SPECIAL PRICES

| 7 x 10 x 3/16 | 69c | 10 x 10 x 3/16 | 95c | 7 x 10 x 1/4 | 35c |
|---------------|------|----------------|------|--------------|-----|
| " 12 " | 83c | " 12 " | 1.15 | " 12 " | 42c |
| " 14 " | 97c | " 14 " | 1.35 | " 14 " | 49c |
| " 16 " | 1.11 | " 16 " | 1.55 | " 16 " | 56c |
| " 18 " | 1.25 | " 18 " | 1.75 | " 18 " | 63c |
| " 20 " | 1.46 | " 21 " | 2.05 | | |
| " 24 " | 1.67 | " 24 " | 2.35 | | |

Real buys in Transmitting tubes, backed by LEEDS usual guarantee of 100% satisfaction.

| | | | | | |
|---------|--------|--------|--------|-------|---------|
| *203-A | \$8.45 | †801 | \$2.95 | *852 | \$11.50 |
| †210-HF | 1.75 | †830 | 6.75 | *860 | 21.50 |
| 866 | 1.50 | †830-B | 7.25 | †865 | 8.45 |
| *211 | 8.45 | *838 | 11.75 | 866-A | 1.95 |
| †304-A | 9.45 | †841 | 2.45 | 872 | 11.75 |
| †800 | 7.25 | 845 | 11.50 | 872-A | 13.25 |

*Graphite Anode Tubes †Isolantite Base

Tubes Shipped by Express Only

We lead the field with low priced, high quality oil immersed condensers.

2 mfd. capacity only. D.C. working voltage, 1,000 volts — \$1.45; 1,500 volts — \$2.00; 2,000 volts — \$2.45.

We lead the field in merchandising standard relay racks and panels. **LEEDS** table racks, 35" high, 20" wide for use with 19" panels.

Type RAD with complete set of drilled and tapped mounting holes.....\$8.95

Type RAU same size as RAD, less mounting holes.....\$5.45

LEEDS 19" RACK PANELS crystalline finish on one side and dull black finish on the other. All panels are 1/8" thick.

| Aluminum | | | | Steel | | | |
|----------|---------|--------|--------|-------|---------|--------|--------|
| No. | Width | Weight | Price | No. | Width | Weight | Price |
| PA1 | 1 1/2" | 2 lbs. | \$1.65 | PS1 | 1 1/2" | 2 lbs. | \$1.05 |
| PA2 | 3 1/2" | 3 " | 1.85 | PS2 | 3 1/2" | 4 " | 1.20 |
| PA3 | 5 1/2" | 3 " | 2.15 | PS3 | 5 1/2" | 6 " | 1.30 |
| PA4 | 7 " | 4 " | 2.35 | PS4 | 7 " | 7 " | 1.35 |
| PA5 | 8 1/2" | 5 " | 2.45 | PS5 | 8 1/2" | 8 " | 1.45 |
| PA6 | 10 1/2" | 6 " | 2.55 | PS6 | 10 1/2" | 10 " | 1.55 |
| PA7 | 12 1/2" | 7 " | 3.00 | PS7 | 12 1/2" | 11 " | 1.70 |



World Wide Service to Amateurs
45 Vesey Street
New York City
Cable Address, "RADLEEDS"

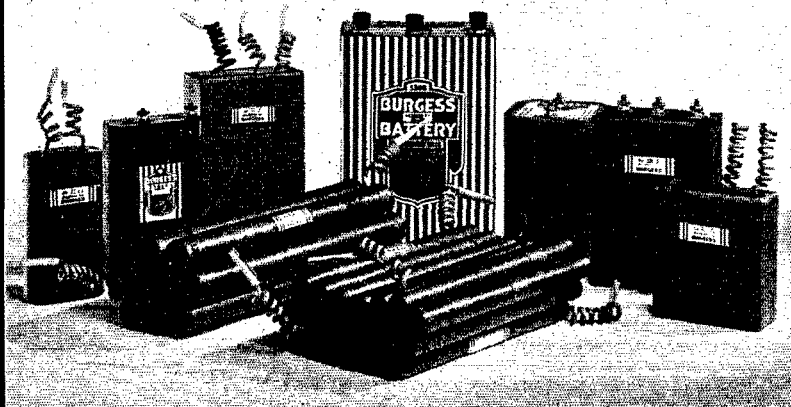

FOR THE U. S. A.
- and You

BURGESS Engineers originally developed many of the new BURGESS Portable Batteries for the U. S. Government, to meet the Government's own exacting specifications. Now these new Batteries are available to you, for use in your transmitters and receivers.

In the group above you see a number of these new BURGESS Portable Batteries. Among them are the compact LITTLE SIX A (which replaces the old type No. 6 cell), the Midget B and C, the standard Portable B (No. 5308), and the flexible Ribbon Battery (an exclusive Burgess development).

You'll be sure to get full-powered, long life Batteries—of the most advanced type—if you ask your dealer for "BURGESS" and look for the familiar Black and White Stripes on the Batteries you buy. BURGESS BATTERY COMPANY, Freeport, Illinois.

BURGESS



HRO COMMUNICATION TYPE RECEIVER

Although designed originally for table use, the HRO is also available for relay rack mounting. The panel is of standard size, of $\frac{3}{16}$ " aluminum and finished in leatherette enamel.

Companion units, finished to match the HRO, are illustrated below. At the left is the power supply unit with the rectifier accessible through the removable ventilated panel. In the center is the coil rack, equipped with a hinged door to protect the five coils not in use. At the right is the monitor speaker panel, equipped with a high grade dynamic speaker with permanent-magnet field.





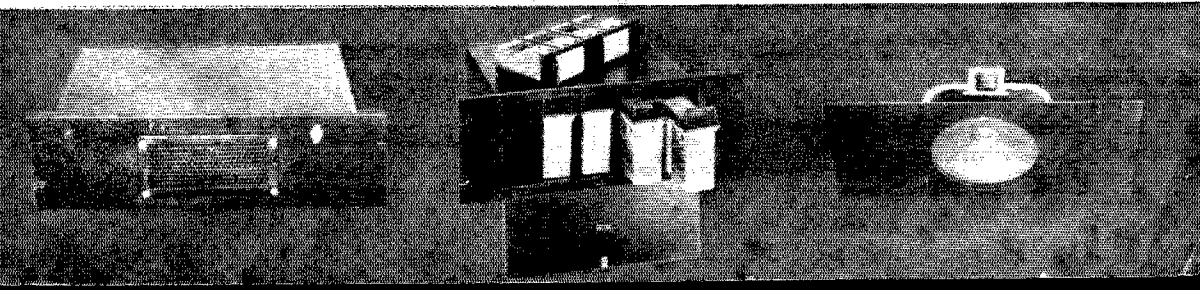







Your dealer will be glad to furnish complete information on this superlative equipment.

NATIONAL COMPANY, INC., MALDEN, MASS.





The Harvest Moon Heralds the Return of DX

Soon those clear, cold, moonlight nights  will be here and the DX will come rolling in  Now is the time to rebuild that main rig  if you are going to get the most out of the season's  schedules. When laying plans,  consider the husky new RCA 803  r-f pentode. Easily excited, requiring no neutralization, and capable of suppressor modulation, it gives your rig a real sock  Then there is the new RCA 838  which has the capabilities of the 203-A plus new features. The RCA 852 also warrants the serious consideration of those who want to go places (the Sudan, for instance)  For the exciter or low-powered stages, there is an almost unlimited choice  of types in the RCA deForest line. A  addressed as below will bring you full information on any RCA type. And remember, when you use RCA tubes in your rig, you won't have to plow miles through the snow  to get a new tube  to replace that bargain which blew just when you were supposed to keep a "sked" with that ZL.

AMATEUR RADIO SECTION, RCA RADIOTRON DIVISION
• RCA MANUFACTURING CO., INC., CAMDEN, N.J. •

The New Edition is Ready!

DESCRIPTIVE PRICE LIST
BULLETIN NO. 250

WANDNA
Radio Products

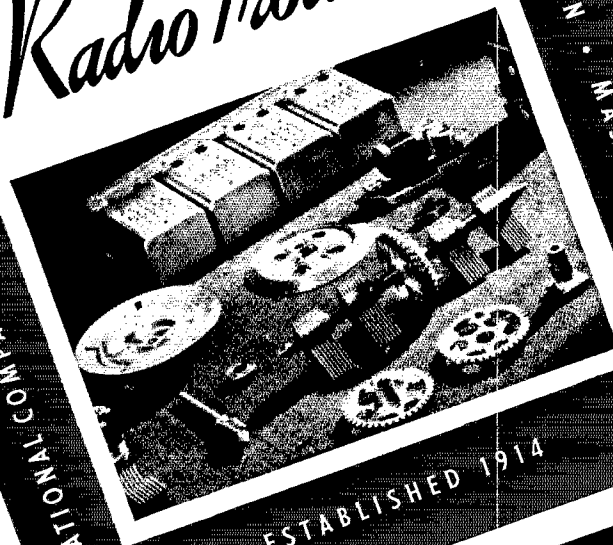

61 SHERMAN STREET • MALDEN • MASSACHUSETTS

NATIONAL COMPANY, INC. • ENGINEERS AND MANUFACTURERS

ESTABLISHED 1914

A Free Copy is Waiting at Your Dealers

PRODUCTS *from the*



This year we are distributing our new general catalogue through our dealers whom you will find listed on the last page of this advertisement. This new catalogue is free for the asking, and you will want a copy.

It is unusual not only because of the products it describes, but even more so for the products it does not describe. For instance, it does not list our new amateur receivers. These receivers are not yet in production, and until they are, we are not going to say much about them. We will say this much in explanation:— one of the new receivers employs automatic plug-in coils. Turning a knob on the panel plugs in each of the six coil ranges in succession. The system combines the efficiency of plug-in coils with the convenience of coil switching, and from almost every viewpoint it is the ideal system. However, in order to sell the new receiver for less than \$100, we are obliged to build such special manufacturing equipment that we are not promising yet just when deliveries will begin. We are working on a definite schedule but because we are determined to do a darn fine job at any cost, we are not making any announcements until the set is actually in production.



We had hoped to have the other new receiver in production by this time. But this receiver is also unique in its own way, and its development has required so much pioneering that we have been obliged to make haste rather slowly. It is designed to cover the range from one to ten meters, and has presented some nice problems. Things are taking shape now, and the “one-ten” begins to look like a nifty job.

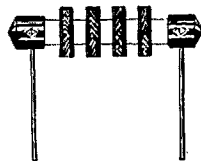

There are not many blank pages in the catalogue,



NATIONAL COMPANY, INC.,

NEW CATALOGUE

however. You will find your old favorites such as the R-100 choke and its bigger brothers, which continue to prove that the amateur knows a good product when he sees it. You will find new favorites such as the

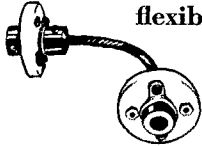

flexible-shaft coupling which makes mechanical hook-up as easy as electrical hook-up. There are new condensers, such as the TMA which is bigger and better for husky transmitters, and the UM condensers which are smaller and better for H.F. circuits. And there are old products with new

ranges, such as the PW-1 precision condenser which now is available in ranges up to 500 mmf. There is also the PW-0, which is the dial and worm drive of the PW condenser, arranged so that it can be used to drive a big condenser or what have you. Perhaps we should also mention that the

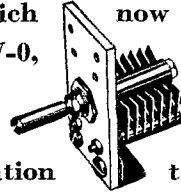

catalogue for the first time lists "gadgets." These gadgets are for the most part queer things that we have for years made for our own use, and found extremely useful. We have never had the courage to put these gadgets on the market before, and even now we are not asking our dealers to stock them. As an example, one of the gadgets is a shelf to screw on a relay rack. Fastened at eye level it is ideal for meters, ash trays, monitors, books, small receivers, etc. Mounted lower it is invaluable as a place to put your feet when you sit down to wonder what to do next. It is all very silly, but believe us, very convenient (especially for thinking).

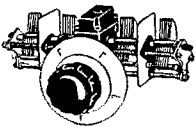

We could go on rambling like this for pages, but we have to stop somewhere. In the new Catalogue Section of the coming 1936 edition of the Handbook, we are inserting a parts catalogue for ready reference. But if you want a complete general catalogue you will have to see your dealer. So we suggest that you dash out and snare a copy of the new catalogue, and study up on these new products yourself.



MALDEN, MASSACHUSETTS

National Radio Products

are marketed through the following distributors who carry a large and complete stock of all the items listed in our No. 250 catalog, announcement herewith. ☹ These concerns extend to the amateur and experimenter a discount of 40% from the list prices. ☹ By dealing directly with the distributor in your territory you will not only be assured of prompt and dependable service but will also be certain of receiving the latest type products in factory sealed cartons.

- ALABAMA**
Auto Service Co., 1920 Fourth Ave. So., Birmingham
- ARIZONA**
Electrical Equipment Co., 424 No. Central Ave., Phoenix
- ARKANSAS**
C. F. Harington Co., 212 E. 20th Street, Little Rock
- CALIFORNIA**
B. J. DeJarnatt, 2501 Tulare Street, Fresno
Ports Mfg. Company, Fresno
Pacific Radio Exchange, 729-31 S. Main St., Los Angeles
Radio Supply Company, 912 So. Broadway, Los Angeles
Radio Television Supply Co., 1701 So. Grand Ave., Los Angeles
Electric Supply Co., 12th & Fallon Sts., Oakland
Radio Supply Co., 2085 Broadway, Oakland
I. S. Cohen's Sons, 1025 Market St., San Francisco
Offenbach Electric Co., 1452 Market St., San Francisco
Coast Electric Co., 744 "G" Street, San Diego
- COLORADO**
Interstate Radio & Supply Co., 1639 Tremont St., Denver
- CONNECTICUT**
Hatry & Young, Inc., 203 Ann St., Hartford
Hatry & Young, Inc., 86 Meadow St., New Haven
- DISTRICT OF COLUMBIA**
National Electrical Supply Co., 1328 New York Ave. N.W., Washington
- DELAWARE**
Delaware Radio Sales Co., 405 Delaware Ave., Wilmington
- FLORIDA**
Pan American Radio, Inc., 1809 N. E. Second St., Miami
Tropical Radio Service Co., 123 Second St. N.E., Miami
Radio Supply & Service Co., 1222 Tampa, Tampa
- GEORGIA**
Garvin Electric Co., 69 Forsyth St. N.W., Atlanta
Wholesale Radio Serv. Co., 430 W. Peachtree St. N.W., Atlanta
- HAWAII**
Honolulu Furniture Co., Cor. Beretania & Emma Sts., Honolulu
- ILLINOIS**
Allied Radio Corp., 833 W. Jackson Blvd., Chicago
Chicago Radio Apparatus Co., 415 S. Dearborn St., Chicago
Midwest Radio Mart, 520 S. State St., Chicago
Newark Electric Co., 226 W. Madison St., Chicago
Klaus Radio & Elec. Co., 707 Main Street, Peoria
- INDIANA**
State Distributing Co., 316 N. Illinois St., Indianapolis
- IOWA**
Iowa Radio Corp., 1212 Grand Ave., Des Moines
Klaus Radio & Electric Co., 320 E. 4th St., Davenport
Warren Electric Co., 647 Water Street, Sioux City
- KENTUCKY**
P. I. Burks & Co., 911 W. Broadway, Louisville
- LOUISIANA**
Interstate Electric Co., Shreveport
Shuler Supply Co., 1700 Poydras Street, New Orleans
- MARYLAND**
Radio Electric Service Co., 303 W. Baltimore St., Baltimore
- MASSACHUSETTS**
H. Jappe Co., 46 Cornhill, Boston
T. F. Gushing, 349 Worthington St., Springfield
Springfield Radio Co., 397 Dwight St., Springfield
H. Jappe Co., 37 Mechanic St., Worcester
- MICHIGAN**
Radio Specialties Co., 171 E. Jefferson Ave., Detroit
- MINNESOTA**
Lew Bonn Co., 2484 University Ave., St. Paul
- MISSOURI**
Burststein-Applebee Co., 1012 McGee St., Kansas City
Radio Labs., 1515 Grand Ave., Kansas City
Walter Ashe Radio Co., 1100 Pine St., St. Louis
Henry Radio Shop, 211 No. Main St., Butler
- NEBRASKA**
Radio Accessories Co., 2855 Farnam St., Omaha
- NEW HAMPSHIRE**
H. Jappe Co., 450 Central Ave., Dover
Radio Service Laboratories, 1008 Elm St., Manchester
- NEW JERSEY**
Wholesale Radio Service Co., 219 Central Ave., Newark
- NEW YORK**
Fort Orange Radio Distr. Corp., 356 Broadway, Albany
Dymac Radio Co., 216 E. Genesee St., Buffalo
Leeds Radio Company, 45 Vesey St., New York City
Sun Radio Co., 227 Fulton St., New York City
Wholesale Radio Service Co., 100 Sixth Ave., New York City
M. Schwartz & Son, 710 Broadway, Schenectady
Roy C. Stage, 265 Erie Blvd., W. Syracuse
- OHIO**
Burns Radio Co., 140 E. Third St., Dayton
Hughes-Peters Elec. Co., 178 N. Third St., Columbus
Northern Ohio Labs., 2073 W. 85th St., Cleveland
Steinberg's, Inc., 633 Walnut, Cincinnati
- OKLAHOMA**
Radio, Inc., 219 So. Boulder Ave., Tulsa
Southern Sales Co., 130 W. 3rd St., Oklahoma City
- OREGON**
United Radio Supply Co. Inc., 1207 S.W. Washington St., Portland
- PENNSYLVANIA**
Cameradio Co., 603 Grant St., Pittsburgh
Radio Electric Service Co., 1024 Hamilton St., Allentown
Eugene G. Wile Co., 10 South 10th St., Philadelphia
Herbach & Rademan, 438 Market St., Philadelphia
M & H Sporting Goods Co., 512 Market St., Philadelphia
Radio Electric Serv. Co., N.E. Cor. 7th & Arch Sts., Philadelphia
- RHODE ISLAND**
W. H. Edwards Co., 32 Broadway, Providence
- TENNESSEE**
Braid Electric Co., 107 Ninth Ave. So., Nashville
Riechman-Crosby Co., 223 So. Front St., Memphis
- TEXAS**
Amateur Supply Co., 1808 St. Louis Ave., Ft. Worth
Straus-Frank Co., Travis & Calhoun, Houston
Straus-Frank Co., 301 S. Flores St., San Antonio
Western Battery & Magneto Co., 315 E. Missouri, El Paso
- UTAH**
O'Loughlin's Wholesale Radio Sup., 315 South Main St., Salt Lake City
- VIRGINIA**
Hudson Radio Supply, 27th & Marshall Sts., Richmond
Newport Radio Service Co., Newport & 35th St., Norfolk
- WASHINGTON**
Spokane Radio Co., 611 First Ave., Spokane
Wedel Co., 520 Second Ave., Seattle
- WEST VIRGINIA**
Cameradio Co. Inc., 30 Twelfth St., Wheeling
- WISCONSIN**
Radio Parts Co., 332 W. State St., Milwaukee
Radio Parts Co., 1214 Regent St., Madison
- CANADA**
Canadian Marconi Company, 211 St. Sacrament St., Montreal and branches, Exclusive Canadian distributor for Receivers and Power Units.

It is obviously impractical to list in a general catalog all of the radio products of our manufacture. Should you not find listed such apparatus as will fully meet your particular requirements, we invite you to write direct to our Engineering Department.